

# JEA Water & Wastewater Standards Manual

Volume I: Distribution and Collection  
Specifications

January 1, 2022 – Edition

“Foundation for the Future – Water & Wastewater Standards”

# JEA Water and Wastewater Standards

## Table of Contents

SECTION I – SUMMARY OF MAJOR CHANGES .....	9
SECTION II – GENERAL SPECIFICATIONS – SITE WORK .....	17
406 - SITE PREPARATION, CLEAN UP AND RESTORATION .....	19
I.    SCOPE OF WORK .....	19
II.   SITE MAINTENANCE .....	19
III.  DISTURBANCES TO EXISTING IMPROVEMENTS .....	19
IV.  SHRUBS .....	19
V.   TREES .....	19
VI.  CLEARING AND GRUBBING .....	19
VII. FENCES AND RETAINING WALLS .....	19
VIII. REMOVAL OF TEMPORARY STRUCTURES AND IMPROVEMENTS .....	19
IX.  CLEANUP OF NEW MATERIALS AND EQUIPMENT .....	20
407 - DEMOLITION AND ABANDONMENT .....	21
I.    SCOPE OF WORK .....	21
II.   GENERAL REQUIREMENTS .....	21
III.  ABANDONMENT .....	21
IV.  REMOVAL .....	22
V.   DISPOSAL OF DEBRIS .....	24
VI.  SALVABLE MATERIAL .....	24
VII. GROUT MIX .....	24
408 - EXCAVATION AND EARTHWORK .....	25
I.    GENERAL REQUIREMENTS .....	25
II.   EXCAVATION PREPARATION .....	25
III.  EXCAVATION .....	27
IV.  BACKFILL MATERIAL .....	28
V.   BACKFILL – STRUCTURES .....	30
VI.  COMPACTION AND DENSITY .....	30
VII. DUST CONTROL .....	33
VIII. SEWAGE SPILLS .....	33
436 – NONFERROUS METALWORK .....	35
I.    SCOPE OF WORK .....	35
II.   GENERAL REQUIREMENTS .....	35
III.  ALUMINUM .....	35
IV.  OTHER ITEMS .....	36
V.   PROTECTION .....	36
VI.  CLEANING .....	37
437 - CONCRETE WORK .....	39
I.    SCOPE OF WORK .....	39
II.   GENERAL REQUIREMENTS .....	39
III.  MATERIALS .....	39

# JEA Water and Wastewater Standards

IV. INSTALLATION.....	42
441 - GRASSING .....	47
I. GENERAL .....	47
II. SCOPE OF WORK.....	47
III. SEEDING AND MULCHING .....	47
IV. SPRIGGING.....	47
V. SODDING.....	47
VI. FERTILIZING .....	48
VII. HYDRO SEEDING: .....	49
VIII. NON GRASSED AREAS .....	49
IX. SOIL MOISTURE .....	49
X. MAINTENANCE .....	49
490 - PAVING.....	51
I. GENERAL .....	51
II. REFERENCE .....	51
491 - SIDEWALK, DRIVEWAY, CURB AND GUTTER.....	53
I. GENERAL .....	53
II. REFERENCE .....	53
492 - FENCING .....	55
I. SCOPE OF WORK.....	55
II. MATERIALS .....	55
III. SELVAGE.....	55
IV. FABRIC CONNECTIONS .....	56
V. POSTS .....	56
VI. GATES .....	57
VII. TENSION WIRE.....	58
VIII. SECURITY FENCE UPDATE .....	58
493 - DRAINAGE .....	59
I. GENERAL .....	59
II. REFERENCE .....	59
<b>SECTION II – GENERAL SPECIFICATIONS – SPECIFICS.....</b>	<b>61</b>
439 - GENERAL EQUIPMENT REQUIREMENTS.....	63
I. SCOPE.....	63
II. EQUIPMENT .....	63
447 - WATER WASTEWATER PROTECTIVE COATINGS .....	65
I. GENERAL REQUIREMENTS .....	65
472 - EMERGENCY GENERATOR (LESS THAN 600 KW) .....	67
494 - INSTRUMENTATION AND CONTROLS INTEGRATOR REQUIREMENTS.....	69
I. GENERAL .....	69
II. INTEGRATOR QUALIFICATION .....	69
III. PROJECT QUALIFICATION .....	69

# JEA Water and Wastewater Standards

495 - VARIABLE FREQUENCY DRIVES.....	73
I.    GENERAL.....	73
II.   VFD SPECIFIC REQUIREMENTS.....	74
III.  WARRANTY.....	74
501 - AS-BUILT DRAWINGS.....	77
I.    GENERAL REQUIREMENTS.....	77
II.   DRAWING REQUIREMENTS.....	79
III.  SPECIFIC SYSTEM REQUIREMENTS.....	81
IV.   ASSET SPECIFIC REQUIREMENTS.....	84
V.    SUBMITTAL TRANSMITTALS AND CHECKLISTS.....	93
801 - MEASUREMENT AND PAYMENT.....	121
I.    GENERAL.....	121
II.   SITE PREPARATION, CLEAN UP AND RESTORATION – SECTION II - 406.....	121
III.  DEMOLITION AND ABANDONMENT – SECTION II - 407.....	121
IV.   NONFERROUS METALWORK – SECTION II - 436.....	124
V.    CONCRETE WORK – SECTION II - 437.....	124
VI.   GENERAL EQUIPMENT REQUIREMENTS – SECTION II - 439.....	125
VII.  GRASSING – SECTION II - 441.....	125
VIII. PAVING – SECTION II - 490.....	125
IX.   SIDEWALK, DRIVEWAY, CURB AND GUTTER – SECTION II - 491.....	127
X.    FENCING – CHAPTER II. 10. - SECTION 492.....	128
XI.   DRAINAGE – CHAPTER II. 11. - SECTION 493.....	128
XII.  POTABLE WATER PIPING – SECTION III - 350.....	129
XIII. WATER VALVES AND APPURTENANCES – SECTION III - 351.....	133
XIV.  SEWAGE MANHOLES – SECTION IV - 427.....	135
XV.   GRAVITY WASTEWATERS – SECTION IV - 428.....	137
XVI.  SEWAGE FORCE MAINS – SECTION IV - 429.....	139
XVII. WASTEWATER VALVES AND APPURTENANCES - SECTION IV - 430.....	141
XVIII. SUBMERSIBLE SEWAGE PUMPING STATIONS – SECTION IV - 433.....	142
XIX.  SPECIALTY COATINGS AND LININGS – SECTION IV - 446.....	142
XX.   EMERGENCY GENERATOR (LESS THAN 600 KW) – SECTION IV - 472.....	142
XXI.  RECLAIMED WATER PIPING – SECTION V - 701.....	142
XXII. RECLAIMED WATER VALVES AND APPURTENANCES - SECTION V - 702.....	144
XXIII. HORIZONTAL DIRECTIONAL DRILLING – SECTION VI - 750 and 755.....	146
<b>SECTION III – WATER DISTRIBUTION SPECIFICATIONS.....</b>	<b>147</b>
350 - POTABLE WATER PIPING.....	149
I.    GENERAL REQUIREMENTS.....	149
III.  INSTALLATION.....	160
IV.   TESTING.....	166
V.    WATER SERVICES.....	174
VI.   RESPONSIBILITY FOR WELL AND MAIN CLEARANCES.....	175

# JEA Water and Wastewater Standards

VII. INSPECTION CHECKLISTS AND REPORTS.....	177
351 - WATER METERS, VALVES, HYDRANTS AND APPURTENANCES .....	185
I. GENERAL REQUIREMENTS .....	185
II. WATER METERS .....	186
III. VALVES .....	197
IV. MISCELLANEOUS VALVES AND APPURTENANCES.....	199
V. FIRE HYDRANTS .....	201
VI. VALVE BOXES .....	202
VII. METER BOXES .....	203
VIII. BACKFLOW PREVENTION DEVICES.....	204
IX. DUCTILE IRON BODY INSERT VALVE.....	204
X. INSPECTION CHECK LISTS AND REPORTS .....	206
<b>SECTION IV – WASTEWATER COLLECTION SPECIFICATIONS .....</b>	<b>215</b>
427 - WASTEWATER MANHOLES .....	217
I. GENERAL REQUIREMENTS .....	217
II. MATERIALS .....	219
III. INSTALLATION.....	229
IV. MANHOLE ABANDONMENT AND REMOVAL .....	233
V. MANHOLE INSPECTION CHECKLIST .....	235
428 - GRAVITY SEWERS .....	237
I. GENERAL REQUIREMENTS .....	237
II. MATERIALS .....	238
III. INSTALLATION.....	243
IV. GRAVITY SEWER ABANDONMENT .....	249
V. PERMITTED CROSSINGS.....	250
429 - WASTEWATER FORCE MAINS.....	253
I. GENERAL REQUIREMENTS .....	253
II. MATERIALS .....	254
III. INSTALLATION.....	269
IV. PRIVATE WASTEWATER PUMP STATION PIPING.....	278
V. TESTING.....	279
VI. LOCATE WIRE.....	283
VII. INSPECTION CHECKLISTS AND REPORTS.....	285
430 - WASTEWATER VALVES AND APPURTENANCES .....	293
I. GENERAL REQUIREMENTS .....	293
II. GATE VALVES.....	294
III. PLUG VALVES.....	295
IV. CHECK VALVES.....	296
V. MISCELLANEOUS VALVES AND APPURTENANCES .....	296
VI. VALVE BOXES .....	298
VII. METER BOXES (SERVICE ACCESS POINTS).....	299

# JEA Water and Wastewater Standards

VIII. DUCTILE IRON BODY INSERT VALVE.....	299
IX. INSPECTION CHECK LISTS AND REPORTS .....	302
433 - SUBMERSIBLE WASTEWATER PUMPING STATIONS .....	311
I. GENERAL REQUIREMENTS .....	311
II. SUBMERSIBLE PUMPS .....	316
III. PUMP STATION ELECTRICAL .....	324
IV. PREFABRICATED CONCRETE BUILDING.....	336
V. VALVES .....	338
VI. TESTING.....	338
VII. REFERENCE POINTS AND LAYOUT.....	340
VIII. PRECAST CONCRETE AND POLYMER CONCRETE WET WELLS .....	340
IX. FIBERGLASS WET WELL .....	343
X. JUNCTION MANHOLES:.....	346
XI. EXCAVATION .....	346
XII. BACKFILL .....	347
XIII. WASH DOWN STATION .....	348
XIV. SITE WORK .....	348
XV. PERMITS .....	349
XVI. LANDSCAPING.....	349
XVII. SPRINKLER SYSTEM .....	349
XVIII. INSPECTION CHECKLISTS AND REPORTS.....	350
435 - BOOSTER WASTEWATER PUMPING STATION.....	367
I. GENERAL REQUIREMENTS .....	367
II. DRY PIT PUMPS .....	371
III. PUMP STATION ELECTRICAL .....	373
IV. PREFABRICATED CONCRETE ENCLOSURE .....	386
V. VALVES .....	388
VI. TESTING.....	388
VII. REFERENCE POINTS AND LAYOUT.....	393
VIII. EXCAVATION .....	393
IX. WASH DOWN STATION .....	393
X. SITE WORK .....	393
XI. PERMITS .....	394
XII. LANDSCAPING.....	395
XIII. SPRINKLER SYSTEM .....	395
XIV. INSPECTION CHECKLISTS AND REPORTS.....	395
445 - OPERATING DATA SUBMISSION REQUIREMENTS .....	411
I. GENERAL REQUIREMENTS .....	411
II. PUMP STATION STANDARD ATTRIBUTE WORKSHEETS.....	416
III. CHECKLISTS AND REPORTS.....	417
446 - SPECIALTY COATINGS AND LININGS.....	423

# JEA Water and Wastewater Standards

I.	GENERAL REQUIREMENTS .....	423
II.	FIBERGLASS REINFORCED POLYESTER (FRP) INTERIOR LINING .....	424
III.	SPECTRASHIELD .....	428
IV.	GREEN MONSTER™ .....	431
V.	SEWPERCOAT .....	434
448 -	EXISTING CONCRETE PREPARATION AND REPAIR .....	437
I.	GENERAL REQUIREMENTS .....	437
II.	PRODUCTS .....	438
III.	SURFACE PREPARATION .....	439
IV.	CONCRETE REMOVAL .....	440
V.	TYPES OF REPAIRS .....	440
VI.	MATERIAL & BY-PRODUCTS .....	444
VII.	SURFACE PREPARATION .....	444
VIII.	CURING .....	444
IX.	QUALITY CONTROL .....	444
470 -	EMERGENCY PUMP ENGINES SECTION .....	445
I.	GENERAL REQUIREMENTS .....	445
II.	DIESEL ENGINE .....	447
III.	PUMP .....	449
IV.	ENGINE STARTING AND CONTROL PANEL .....	449
V.	FUEL STORAGE TANK .....	453
VI.	TESTING REQUIREMENTS .....	457
VII.	COATINGS .....	457
VIII.	START-UP .....	458
471 -	BYPASS PUMPING REQUIREMENTS .....	459
IX.	SCOPE OF WORK .....	459
X.	SUBMITTALS .....	459
XI.	QUALITY ASSURANCE .....	460
XII.	BYPASS DESCRIPTION .....	460
XIII.	PRODUCTS .....	460
XIV.	EXECUTION .....	461
701 -	RECLAIMED WATER PIPING .....	467
I.	GENERAL REQUIREMENTS .....	467
II.	MATERIALS .....	468
III.	INSTALLATION .....	468
IV.	TESTING .....	468
702 -	RECLAIMED WATER METERS, VALVES AND APPURTENANCES .....	471
I.	GENERAL .....	471
II.	RECLAIMED WATER METERS AND METER BOXES .....	472
III.	VALVES AND APPURTENANCES .....	472
IV.	INSPECTION CHECK LISTS AND REPORTS .....	473

# JEA Water and Wastewater Standards

703 - RECLAIMED WATER DELIVERY STATIONS.....	479
I.    GENERAL .....	479
II.   MATERIALS .....	480
III.  ELECTRICAL .....	480
IV.   SITE WORK .....	483
V.    PERMITS .....	484
VI.   RECLAIMED DELIVERY STATION INSPECTION.....	484
VII.  INSPECTION CHECKLISTS AND REPORTS.....	484
<b>SECTION VI – OTHER SPECIFICATIONS .....</b>	<b>487</b>
750 - SMALL PIPE HORIZONTAL DIRECTIONAL DRILLING (PIPE 12 INCHES OR LESS).....	489
I.    GENERAL REQUIREMENTS .....	489
II.   MATERIALS .....	496
III.  EQUIPMENT REQUIREMENTS.....	498
IV.   DRILLING PROCEDURES .....	501
V.    SWABBING .....	505
VI.   TESTING.....	506
VII.  LOCATE WIRE.....	508
VIII. COMPLIANCE.....	509
IX.   INSPECTION CHECKLISTS AND REPORTS.....	509
755 - LARGE PIPE HORIZONTAL DIRECTIONAL DRILLING (PIPE LARGER THEN 12 INCHES) .....	513
I.    GENERAL REQUIREMENTS .....	513
II.   MATERIALS .....	520
III.  EQUIPMENT REQUIREMENTS.....	522
IV.   DRILLING PROCEDURES .....	525
V.    SWABBING .....	529
VI.   TESTING.....	530
VII.  LOCATE WIRE.....	533
VIII. COMPLIANCE.....	533
IX.   INSPECTION CHECKLISTS AND REPORTS.....	533



*Blank Page*

## SECTION I – SUMMARY OF MAJOR CHANGES

Highlighted sections are additions, strikethroughs are deletions

### 1) 433 - SUBMERSIBLE WASTEWATER PUMPING STATIONS

#### 1.9.7 ELECTRICAL CONTROL BUILDING

For stations with **more than 3** ~~or more~~ pumps, and/or with motors larger than 75 HP and/or have a full load amperage of greater than ~~or equal to~~ 400 amps, an electric power and control building shall be provided in accordance with Prefabricated Concrete Enclosure standards in this section. Control building required if any of the below conditions exists:

- Pumps larger than 75 hp
- Station FLA > 400 amps
- Station has > 3 pumps

### 2) 501 – AS BUILT DRAWINGS

#### IV.6. METERS AND METER BOXES

IV.6.1. Each meter box shall be shown on the as-built drawings. **The size meter to be installed in the meter box shall also be indicated adjacent to the meter box or meter box notes.** Horizontal dimensioning on the as-built is not required if meter box is located as per standards and is in a residential subdivision.

IV.6.2. Each meter box shall be designated in a meter box table, inserted in a conspicuous location within the As-Built, with the following data. Minimum font on as-built data tables shall be 8 pts. Provide a separate meter box table for water and reclaimed water meter boxes.

- Meter Box Number
- **Proposed meter size to be installed by JEA**

#### IV.10. DATA TABLE EXAMPLES

Sample Water Meter Box Table:

Meter Type & Lot Number	Service Type	Proposed Meter Size
WM1	Water	1 ½"
WM2	Water	1 ½"

# JEA Water and Wastewater Standards

Sample Reclaimed Meter Box Table:

Meter Type & Lot Number	Service Type	Proposed Meter Size
RM1	Reclaimed	1 ½"
RM2	Reclaimed	1 ½"
RM3	Reclaimed	1 ½"

## V.3.JEA AS-BUILT OR RECORD DRAWING SUBMITTAL REQUIREMENTS CHECK LIST PIPELINES AND PUMPING STATIONS

### WATER METERS AND METER BOXES

Each meter box shall be listed in the data table with meter number matching the Lot #. If no Lot # exists, assign a water meter ID not included in the Lot # series. Show this meter ID at the meter on the as-built and in the data table.

Location of meter boxes indicated and referenced to property lines (not necessary for 2 inch or less residential meters located as per standards).

#### The size meter to be installed for each meter

Table included with data for each water meter box:

- Meter Box Number
- **Proposed Meter Size**
- Service Type (Water or Reclaimed Water)
- Meter Subtype = Minor Meter (<2"), Major Meter
- Facility Owner (JEA or PRIVATE)
- Meter box manufacturer
- Meter Box Material
- State Plane Northing, Y Coord
- State Plane Easting, X Coord
- Latitude (in Decimal Degrees)
- Longitude (in Decimal Degrees)

### RECLAIMED WATER METER BOXES

Each meter box shall be listed in the data table with meter number matching the Lot #. If no Lot # exists, assign a reclaimed water meter ID not included in the Lot # series. Show this meter ID at the meter on the as-built and in the data table.

#### The size meter to be installed for each meter

Table included with data for each meter box:

- Meter Box Number
- **Proposed Meter Size**
- Service Type (Water or Reclaimed Water)
- Meter Subtype = Minor Meter (<2"), Major Meter

# JEA Water and Wastewater Standards

- Facility Owner (JEA or PRIVATE)
- Meter box manufacturer
- Meter Box Material
- State Plane Northing, Y Coord
- State Plane Easting, X Coord
- Latitude (in Decimal Degrees)
- Longitude (in Decimal Degrees)

## 3) SECTION 350 VI.4.1 CORRECTION—LANGUAGE REMOVAL

### VI.4.1 WATER MAINS

Upon completion of water main flushing, samples shall be submitted until satisfactory results are obtained on two (2) successive working days (~~Fridays and Mondays are considered successive for this purpose~~). Great care must be exercised in sampling because if the initial disinfection fails to produce satisfactory results, disinfection must be repeated and samples resubmitted. As outlined above, arrangements shall be made with JEA and the JEA Water Quality Lab for all collection of bacteriological samples from systems to be connected to JEA systems and for sampling of privately owned systems. Samples shall be collected in sterile bottles or bags, treated with sodium thiosulfate to neutralize chlorine residual. It is important that the chlorine residual (maximum 4.0 ppm allowed) and pH of the line (main) be taken and recorded in columns (3) and (4) of the Department of Health Form DH 655-1/97 (if the Department of Health Lab is not used for analysis then the lab's substitution form must have the same format). Hoses are not satisfactory sampling points. A suggested sampling tap consists of a standard corporation cock installed in the main with tube goose-neck assembly which may be removed after use or retained for future use as a sampling point. Samples shall be taken at all dead ends and at intervals of no greater than 1000 feet on continuous pipe runs. All permitted service stubs (domestic, irrigation or fire) shall be sampled at the meter location or the backflow location. Bacteriological test results shall be considered unacceptable if the tests were completed more than 60 days before the Department received the results.

## 4) 501 – AS BUILT DRAWINGS

### II. DRAWING REQUIREMENTS

II.1.20. A call out shall be provided identifying the points of connection of the new project to the existing JEA infrastructure.

### V.3. JEA AS-BUILT OR RECORD DRAWING SUBMITTAL REQUIREMENTS CHECK LIST PIPELINES AND PUMPING STATIONS

\_\_\_\_\_ Call outs provided showing points of connection to existing JEA infrastructure.

\_\_\_\_\_ Water pressure and/or force main pressure sensors are identified.

## 5) Section 495

II.4.5. Front panel mounted potentiometers are permitted and must be rated as corrosion resistant.

# *JEA Water and Wastewater Standards*

## 6) Section 428 Gravity Sewers

### III.4.2. REPORTS REQUIRED

A full report, as to the condition of pipe, type, depth, location of services at the main and termination point at the property line, length, type joint, and distance between manholes, etc., shall be furnished to JEA prior to the final acceptance of the main. Each manhole shall be identified on the DVD and report by manhole number and nearest address or intersection. In addition to the written report, a DVD disc (formatted for Windows Media Player or JEA approved equal) of the TV inspection of the main and each service conducted via lateral launch from the main shall be provided to JEA for review. The disc shall become the property of JEA.

7) All Class I pump stations now require a flow metering device (Ultrasonic or Mag type)

8) NEW SECTION 471 Bypass Pumping Requirements

*Blank Page*



*Blank Page*





## SECTION II – GENERAL SPECIFICATIONS – SITE WORK

- 406 - Site Preparation, Cleanup & Restoration
- 407 - Demolition and Abandonment
- 408 - Excavation and Earthwork
- 436 - Nonferrous Metalwork
- 437 - Concrete Work
- 441 - Grassing
- 490 - Paving
- 491 - Sidewalk, Driveway, Curb and Gutter
- 492 - Fencing
- 493 - Drainage

*Blank Page*

## **406 - SITE PREPARATION, CLEAN UP AND RESTORATION**

### **I. SCOPE OF WORK**

The work under this section includes the site preparation, clean up and restoration work for all sections of the entire project as set forth on the plans and as outlined herein.

### **II. SITE MAINTENANCE**

The Contractor shall keep the working area free at all times of materials and equipment not essential to the progress of the work.

### **III. DISTURBANCES TO EXISTING IMPROVEMENTS**

The contractor will be responsible for protection and preservation of existing improvements including necessary removal and storage of such improvements and subsequent replacement to obtain to the fullest extent possible, the undisturbed condition. The contractor shall restore or replace, when and as directed, any public or private property damaged by its work, equipment or employees, to a condition at least equal to that existing immediately prior to the beginning of its operations. To this end the contractor shall do as required all necessary highway, driveway, walk or landscaping, etc. Suitable materials, equipment and methods shall be used in such restoration.

### **IV. SHRUBS**

Shrubs within the limits of excavation not shown or directed to be removed shall be taken up with sufficient root ball and soil, suitably stored and watered and replaced as soon as backfilling permits. Shrubbery mishandled or damaged during construction operations so that it does not survive upon completion of the work shall be replaced with similar vegetation and maintained until survival is assured.

### **V. TREES**

Trees, stumps and roots within limits of trench excavations designated to be removed shall be removed to a depth of 12 inches minimum below bottom of trench excavation. Stump and root holes shall be refilled to existing grade and compacted by tamping. Trees not to be removed shall be limited as to root and limb removal to the minimum clearance necessary by making clean, unbroken cuts.

### **VI. CLEARING AND GRUBBING**

The area within limits shown on the plans shall be cleared of fences, trees, logs, stumps, brush, vegetation, rubbish and other perishable or objectionable matter; specifically excepting certain fences, trees and shrubs which are to remain undisturbed and protected as directed or as indicated on the plans. No stumps, roots, or perishable matter of any description shall remain under concrete slabs or footings.

### **VII. FENCES AND RETAINING WALLS**

If the construction work so requires, affected fences and/or retaining walls shall be carefully removed and later re-installed by personnel qualified to accomplish such work. The condition of the re-installed facilities shall be equal to the original facilities.

### **VIII. REMOVAL OF TEMPORARY STRUCTURES AND IMPROVEMENTS**

On or before the completion of the work, the Contractor shall, unless otherwise directed or permitted in writing, tear down and remove all temporary buildings and structures built by him; shall remove all temporary works, tools and machinery or other construction equipment furnished by him; shall remove portable bathroom facilities, houses, and other buildings used by him; shall remove all rubbish from any grounds which he has occupied; and

*JEA Water and Wastewater Standards  
406 Site Preparation, Clean Up and Restoration*

shall leave the roads and all parts of the premises and adjacent property affected by his operations, in a neat and satisfactory condition.

**IX. CLEANUP OF NEW MATERIALS AND EQUIPMENT**

The Contractor shall thoroughly clean all materials and equipment installed by him and his subcontractors and upon completion of the work shall deliver it undamaged and in fresh and new appearing condition.

## 407 - DEMOLITION AND ABANDONMENT

### I. SCOPE OF WORK

The Contractor shall furnish all materials, labor, supervision, and equipment required for the orderly demolition, abandonment, removal, and/or salvaging of existing structures, piping, valves, fittings, appurtenances, and other equipment, as shown on the drawings and described herein. All references to industry standards (AWWA, ASTM, etc.) shall be to latest version unless otherwise noted.

### II. GENERAL REQUIREMENTS

Structures, equipment, piping and other improvements to be demolished or removed shall be as detailed on the drawings. Demolition shall be accomplished in a neat and careful manner so as not to damage adjacent structures, or unnecessarily interfere with existing operations. Fill shall be provided to match existing grades and the area spot sodded and grassed or replacement pavement provided as specified in these specifications. All demolition and abandonment work to be completed by the contractor shall be specifically noted on the project documents. The following table may only be used by the design engineers during the design phase of the project. It shall be noted that the contractor shall complete the demolition and abandonment work as noted in the contract documents.

Item	Allowable demolition and Abandonment methods			
	Sealing Ends	Grout Fill	Removal	Crushed in-Place
Pressure Mains:				
1. Piping not under roadway:				
a) 12-inch and smaller	x	x	x	x
b) Larger than 12-inch		x	x	x
2. Piping under roadway:				
a) 6-inch and smaller	x	x	x	x
b) Larger than 6-inch		x	x	x
Gravity Wastewater Mains:				
a) 8-inch and smaller	x	x	x	x
b) Larger than 8-inch		x	x	x

### III. ABANDONMENT

#### III.1. PIPELINES

##### III.1.1. ABANDONMENT BY PLUGGING

Abandonment of 2" mains shall include a new galvanized plug fitting installed directly into the tee fitting or corporation stop located on the remaining active main. The bid amount for abandonment of 2" mains shall include this work. When called for on the Contract Drawings, abandoned mains 3" and larger shall be plugged with a plugged fitting at points specified. All plugs shall be

# *JEA Water and Wastewater Standards*

## *407 Demolition and Abandonment*

appropriately sized and shall conform as applicable to Chapters in Sections 350, 428, 429 or 701 of these specifications.

### **III.1.2. ABANDONMENT BY GROUT FILLING**

When called for on the Contract Drawings, the abandoned main shall be grout filled by pumping a grout mixture into the main with an approved grout. The main shall be completely filled, leaving no voids or air spaces. Grout mix shall be as specified in this specification section. A pressure grout pump (of suitable size) shall be utilized in the grouting of existing pipes. Unless approved otherwise by JEA, the grout shall be pumped into the pipe from the inlet end to the receiving end (exit end). Samples of the outgoing water (exit end) shall be made until the existing grout mix is observed which is similar (i.e.: within 90% of same density or other JEA approved method) to the grout being injected at the inlet end. The cost of the testing, including labor and testing equipment (scales) shall be provided by the contractor and the associated testing cost shall be included in the contractor's unit price for the grouting work. If requested by JEA, the contractor shall provide a comprehensive grouting plan which details all of the means and methods for completing this work. This grouting plan, including the grout mix design shall be reviewed and approved by JEA prior to initiating this work.

### **III.1.3. ABANDONMENT BY SEALING**

All below grade pipe to be abandoned by sealing, either as noted on the Contract Drawings or as a result of demolition of a structure, shall be sealed with grout, Class "C" concrete or brick and mortar. The grout, concrete or brick and mortar shall extend into the pipe for at least 12 inches, forming a solid waterproof plug completely bonded to the pipe.

### **III.1.4. ABANDONMENT OF ASBESTOS PIPE**

The Contractor shall comply with all work site, air emission, solid waste and personal safety and protection regulations as related to the excavation, exposure, cutting, handling, containment and disposal of existing pipe material. The removal, encapsulation or enclosure, storage and disposal of pipe materials containing asbestos shall be in accordance with Sections 455.301 through 455.309 of the Florida State Statutes, American Water Works Association Manual of Water Supply Practices No. M16 "Work Practices for Asbestos-Cement Pipe," OSHA 29 CFR 1910.100, 1926.1101 Appendix F, Asbestos NESHAP; 40CFR 61-Subpart M, 40CFR 763-Appendix D and all requirements delineated in the latest edition of the JEA Contractor Safe Work Practices Manual Chapter 6, Section V entitled - Asbestos Handling Procedures. Abandonment of asbestos piping shall be by either grout filling or sealing. While cutting asbestos pipe the operator must wear a HEPA type particle mask and adhere to all applicable safety standards for handling asbestos containing material.

## **III.2. STRUCTURES**

The structure shall be removed to a point 36 inches below grade or as noted on the drawings. The remaining structure shall be filled with AASTHO Class A-3 soil, free of organic matter or other deleterious material, compacted to 100% of maximum density as determined by the Laboratory Standard Procter Test, ASTM D698. A tolerance of minus 2% will be allowed in the compactive effort. All pipes leading in and out of the structure to be abandoned shall be sealed or grout filled in accordance with this specification section and as indicated on the Contract Drawings. The portion of the structure to be removed shall be removed from the site and disposed of at an approved disposal facility.

## **IV. REMOVAL**

# *JEA Water and Wastewater Standards*

## *407 Demolition and Abandonment*

### **IV.1. PIPELINES**

#### **IV.1.1. BELOW GRADE**

When called for on the Contract Drawings, removal of existing pipelines shall mean complete removal of the existing pipeline and disposal of the pipe and appurtenances (valves, fittings, thrust blocks, etc.) not indicated to be salvaged. Backfill and compaction shall conform to Chapter II. 3. - Section 408, Excavation and Earthwork of this specification.

#### **IV.1.2. ABOVE GRADE**

All existing piping and appurtenances (valves, fittings, etc.) located above ground shall be removed to a minimum of 36 inches below the finish grade. The abandoned pipe ends, below grade, shall be sealed with Class "C" concrete or completely grout filled as specified in this section and as indicated on the Contract Drawings.

#### **IV.1.3. ASBESTOS PIPE**

IV.1.3.1. Removal of asbestos pipe shall be in accordance with above. While cutting asbestos pipe, the operator must wear a HEPA type particle mask and adhere to all applicable safety standards for handling asbestos containing material. Asbestos pipe may be disposed of in an approved landfill site. The removal, encapsulation or enclosure, storage and disposal of pipe materials containing asbestos shall be in accordance with Sections 455.301 through 455.309 of the Florida State Statutes, American Water Works Association Manual of Water Supply Practices No. M16 "Work Practices for Asbestos-Cement Pipe," OSHA 29 CFR 1910.100, 1926.1101 Appendix F, Asbestos NESHAP; 40CFR 61- Subpart M, 40CFR 763-Appendix D and all requirements delineated in the latest edition of the JEA Contractor Safe Work Practices Manual Chapter 6, Section V entitled - Asbestos Handling Procedures. The Company shall fully comply with all safety related federal, state, and local laws, statutes, ordinances, rules, regulations, requirements, guidelines. The Company shall retain or provide a "competent person" as defined by OSHA's Subpart Z, 29 CFR 1926 1101 to oversee the AC Pipe Removal and Disposal work via a valid Negative Exposure Assessment work plan and to monitor for compliance with all applicable regulations including; but not limited to, OSHA's Subpart Z, 29 CFR 1926 1101, CFR 40 Part 61, Subpart M, Chapter 469, F.S. and Rule 376.60, Florida Administrative Code. This requires; but is not limited to, the preparation of a Negative Exposure Assessment work plan, Delineation of the "Regulated Area", "Demarcation" of the Regulated Area, Periodic Monitoring, Record Keeping, and Signage for the Regulated Area as well as for the AC pipe disposal containers.

IV.1.3.2. To comply with Federal NESHAP Regulations, the Contractor must complete, sign and submit (via certified US Mail) to the COJ Environmental Quality Division the latest version of FDEP Form 62- 257.900(1) titled "Notice of Demolition or Asbestos Renovation". Form must be received by the COJ at least 10 days prior to the commencement of the asbestos abatement and/or demolition.

IV.1.3.3. Contractor will contact JEA safety representative one week in advance for air monitoring requirements. Cost incurred by the Contractor to coordinate the work, provide competent person, and compliance shall not be paid for separately, but shall be included in the cost of the associated removal and disposal item.



# *JEA Water and Wastewater Standards*

## *407 Demolition and Abandonment*

### **IV.2. STRUCTURES**

Removal of existing structures, where designated on the drawings, shall be the complete removal of the existing structures. The existing structures shall be removed from the site. Any or all existing pipes in and out of the structure to be removed shall be plugged, grout filled, sealed or connected to the new structure as specified and as indicated on the Contract Drawings. The void left by the structure removal shall be filled and compacted in accordance with Chapter III.3. - Section 408, Excavation and Earthwork of this specification.

### **V. DISPOSAL OF DEBRIS**

All material not salvable shall be considered debris and disposed of by hauling to an approved disposal site. The Contractor shall be responsible for the disposition of all debris.

### **VI. SALVABLE MATERIAL**

All equipment, piping, fittings, valves and appurtenances to be removed or abandoned shall be inspected by JEA or its representative immediately prior to removal or abandonment. JEA's decision as to the solvability shall be final. Such material which is, in the opinion of JEA or its representative, salvable shall be removed and transported to a location within the City of Jacksonville, Florida as designated by JEA. If the equipment is not wanted by JEA, the Contractor shall become the owner of the equipment and shall dispose of same. Under no circumstances may existing structures, piping or equipment be removed or demolished without obtaining approval from JEA or its representative. The Contractor shall be responsible for transporting the salvable material to the desired location.

### **VII. GROUT MIX**

Grout for filling abandoned mains shall comply with flowable fill material as defined in Chapter II. 3. - Section 408

## **408 - EXCAVATION AND EARTHWORK**

### **I. GENERAL REQUIREMENTS**

#### **I.1. SCOPE**

The Contractor shall make all excavations for piping and appurtenant structures in any material encountered to the depth and grades indicated on the plans, shall backfill such excavations and dispose of excess or unsuitable materials from such excavations, and shall provide and place necessary borrow material to properly backfill excavations, all as indicated on the drawings, specified herein or as directed by the Engineer.

#### **I.2. MAINTENANCE OF TRAFFIC**

The contractor shall provide suitable and safe temporary bridges, crossings or access ways during construction to maintain traffic and/or provide access to private property, and shall remove said structures after construction is complete.

#### **I.3. OPEN EXCAVATION**

The extent of excavation open at any one time will be held to a minimum consistent with normal and orderly prosecution of the work but shall always be confined to the limits set by the engineer for the prevailing conditions.

#### **I.4. INDUSTRY STANDARDS**

All references to industry standards (ASTM, ANSI, AWWA, etc.) shall be to the latest revision unless otherwise stated.

### **II. EXCAVATION PREPARATION**

#### **II.1. CUTTING PAVEMENT**

**II.1.1.** Bituminous pavement shall be removed to clean straight lines by saw cutting. Where bituminous pavement adjoins a trench, the edges adjacent to the trench will be trimmed to neat straight lines before resurfacing to ensure that all areas to be resurfaced are accessible to rollers or tampers used to compact the sub-grade or paving materials.

**II.1.2.** Concrete pavement shall be removed to neatly sawed edges. Saw cuts shall be made to a minimum depth of 1½ inches. If a saw cut in concrete pavement falls within 3 feet of a construction joint, cold joint, expansion joint or edge, the concrete shall be removed to the joint or edge. The edges of existing concrete pavement adjacent to trenches, which had been damaged subsequent to saw cutting of the pavement, shall be saw cut to neat straight lines for the purpose of removing the damaged pavement areas. Such saw cuts shall be parallel to the original saw cuts or shall be cut on an angle which departs from the original saw cut not more than 1 inch in 6 inches.

**II.1.3.** Concrete curb, walk, gutters and driveways shall be removed to neatly sawed edges with saw cuts to a minimum depth of 1½ inches. Concrete sidewalk or driveway to be removed shall be neatly sawed in straight lines parallel to the curb or at right angles to the alignment of the sidewalk. No section to be replaced shall be smaller than 3 feet in either length or width. If the saw cut in sidewalk or driveway should fall within 3 feet of a construction joint, expansion joint, or edge, the concrete

# *JEA Water and Wastewater Standards*

## *408 Excavation and Earthwork*

shall be removed to the joint or edge except that where the saw cut would fall within 12 inches of a score mark, the saw cut shall be made in and along the score mark. Curb and gutter shall be sawed to a depth of 1½ inches on a neat line at right angles to the curb face.

### **II.2. SHEETING, SHORING AND BRACING**

- II.2.1. The contractor shall provide and install such sheeting and shoring as may be required to support the sides of any excavation to prevent earth movement that could endanger the work, workers, or any existing structures, or to confine the construction within a specified area such as an easement or street right-of-way. It shall be the contractor's responsibility to place this sheeting and shoring for such protective purposes without the engineer's instructions.
- II.2.2. All Excavation Work Shall Be In Accordance With OSHA Safety Standards, Including OSHA Excavation Standards (29 CFR Subpart P 1926.650).
- II.2.3. Steel sheeting shall be left in place only when so authorized by the engineer. The top of steel sheeting left in place shall be no less than 30 inches below grade unless otherwise shown on the drawings, or directed by the engineer.
- II.2.4. All sheeting extending below the level of 1 foot above the top of pipelines shall be cut off as directed by the engineer and left in place. All sheeting to be removed shall be carefully extracted in such manner as not to endanger other structures and all voids left shall be immediately backfilled with approved material and compacted as required.
- II.2.5. Steel drag shields or trench boxes may be used. Voids left by the advancement of the drag shield shall be carefully backfilled and compacted in accordance with trench backfill requirements.

### **II.3. DEWATERING**

- II.3.1. The contractor shall at all times during construction provide ample means and devices with which to promptly remove and dispose of all water entering trench and structure excavations and shall keep said excavations acceptably dry (as approved by JEA's representative), until the pipe and/or structures to be built therein are installed and backfilling is completed. All water pumped or drained from the site shall be disposed of in a suitable manner without damage to storm wastewater, pavement, pipes, electrical conduits, or any other work or property.
- II.3.2. Drainage for the excavation shall be adequate. No pipe shall be laid in water and no water shall be allowed to rise above the bottom of any pipe while it is being jointed, except as otherwise permitted in writing. No masonry shall be placed in water and no water shall be allowed to rise over masonry until the concrete or mortar has attained its initial set. Water shall not be allowed to run over completed masonry for 4 days. In no event shall water be allowed to rise so as to set up unequal pressures in the structures until the concrete or mortar has set at least 24 hours and also, until any danger of flotation has been removed.
- II.3.3. If dewatering with sock drain system, contractor shall not install more than 400 feet per run. Upon completion of dewatering with a sock, the contractor shall remove the sock. If unable to remove the sock drain system, contractor shall abandon fill the system with grout. Contractor shall remove grout-filled sock drain ends to a depth of 48 inches below finished grade, and seal/cap each end. The contractor shall locate the ends of all capped sock drains and show the limits of the abandoned

# *JEA Water and Wastewater Standards*

## *408 Excavation and Earthwork*

drain system on the as-built plans. No separate payment shall be made for seals/caps, all cost shall be included in the associated item of work.

- II.3.4. The contractor shall be responsible for utilizing acceptable means and methods, as necessary to place and completely backfill to finished grade new mains and structures in a water free excavation. The means and methods of dewatering the excavation shall comply with all regulatory requirements for temporary diversion of groundwater and its discharge (including FAC Chapter 62-621 "General Permit For The Discharge Of Produced Ground Water From Any Non-Contaminated Site Activity"). The cost associated with excavation dewatering is to be included in all items of work requiring same.

### III. EXCAVATION

#### III.1. TRENCH EXCAVATION

- III.1.1. All excavation for piping shall be open cut. Tunneling will not be permitted unless specifically called for on the plans. Trench sides shall be approximately vertical between an elevation of 1 foot above the top of the pipe and the center line of the pipe; otherwise, trench sides shall be as vertical as possible or as required by OSHA standards. Trench may be excavated by machinery to a depth that will not disturb the finished grade. All trench and excavation cutting requiring protective sheeting, shoring, trench shields and boxes, and other osha required means, methods and devices shall be designed by a Florida licensed professional engineer for live and dead loads and groundwater conditions. The cost associated with this design effort(s), furnishing and installation of sheeting, shoring, trench shield and boxes is to be included in all items of work requiring same unless provided otherwise on the bid form.
- III.1.2. Trench width shall be as narrow as practicable or as required by OSHA standards.
- III.1.3. Bell holes shall be dug to permit the entire straight barrel of the pipe to rest on the undisturbed trench bottom. Boulders or loose rocks which might bear against the pipe will not be permitted in the trench bottom. Embedment material shall be worked in under the haunches of the pipe to ensure complete contact with the pipe bottom.
- III.1.4. If rock is encountered, excavation shall be made to at least 6 inches below the finished grade of the pipe and the resultant over-excavation shall be filled and compacted with suitable bedding material. No section of pipe shall rest directly on rock.
- III.1.5. Excavated material consisting of muck, mud or other undesirable material shall not be stockpiled for backfill. The contractor shall remove such material from the site as it is excavated and shall dispose of it in areas provided by the contractor.
- III.1.6. The contractor's attention is directed to the existence of service piping crossing the new construction as indicated in general on the drawings. The locations shown are approximate only and the contractor will be responsible for locating these and other utilities which may not be shown. The contractor shall be required to maintain uninterrupted service to the buildings along the project, but the methods used to accomplish this shall be left to the contractor's discretion, subject to approval of the engineer. Services damaged or removed to facilitate construction shall be replaced as specified in the applicable section of this specification.

#### III.2. EXCAVATION FOR STRUCTURES

# *JEA Water and Wastewater Standards*

## *408 Excavation and Earthwork*

- III.2.1. The contractor will be held responsible for prosecuting the work in accordance with the lines and grades shown on the contract drawings. Banks of excavation shall be sloped at a safe angle or shoring shall be used.
- III.2.2. The contractor shall do all the excavating of every description of whatever substance encountered, to the dimensions and depths indicated on the drawings.
- III.2.3. Excavations shall be made wide enough to allow for inspection.
- III.2.4. Where structures are not supported on piles, all loam, organic, or other unsuitable material shall be removed and replaced with suitable material as defined by the specifications.

### **III.3. EXCAVATION BELOW NORMAL GRADE**

In the event the Contractor through error or otherwise excavates below the elevation required, the Contractor shall at its own expense backfill with AASHTO Class A-3 soil or granular backfill, if approved by the Engineer, and compact to obtain a suitable pipe bedding or structure support as defined in the specifications.

## **IV. BACKFILL MATERIAL**

### **IV.1. EXCAVATED MATERIAL (NATIVE BACKFILL)**

- IV.1.1. Excavated native earth free from perishable and objectionable objects and containing no stones or clods larger than 2 inches in diameter and not comprised of fully granular material (unless authorized by the Engineer) shall be used for backfilling and such grading on site as is required. Any excess material shall be removed and disposed of by the Contractor.
- IV.1.2. Excavated material to be used for backfill shall be neatly deposited at the sides of the trenches where space is available. Where stockpiling of excavated material is required, the Contractor shall be responsible for obtaining the sites to be used and shall so maintain the operations as to provide for natural drainage and not present an unsightly appearance. No excavated material shall be placed on private property without the written consent of the property owner.
- IV.1.3. Material from the excavations suitable for topsoil shall be deposited in piles separate from other excavated material. Piles of topsoil shall be located so that the material can be used readily for the finished surface grading or as directed by the Engineer, and shall be protected and maintained until needed. At the option of the Contractor, topsoil material for use in finished grading may be obtained from other locations, upon approval.
- IV.1.4. Where materials unsuitable for backfill are excavated within the limits of excavation shown on the drawings, and as directed by the Engineer, the unsuitable material shall be removed from the job site and disposed of by the Contractor. If the stockpiled suitable excavated material is insufficient, suitable Class A-3 soil shall be provided to replace the unsuitable materials, with measurement and payment made on the basis of unit price set forth in the Contract for Class A-3 soil. In no event shall amount of measurement exceed the quantity defined in Measurement and Payment or authorized to be excavated by the Engineer.
- IV.1.5. Unsuitable material shall include pile foundations, concrete, railroad tracks, debris, muck, clay, large clods, stones, wood, stumps, roots or other deleterious material, etc. All unsuitable materials must be verified by the Engineer prior to removal and replacement.

# JEA Water and Wastewater Standards

## 408 Excavation and Earthwork

### IV.2. AASHTO CLASS A-3 SOIL BACKFILL

The Contractor shall furnish, place, and compact AASHTO Class A-3 soil, free of organic or other unsuitable material in quantities which would render the soil unsuitable for backfill or bedding as specified herein, in authorized excavation above or below normal grade and in other locations as indicated on the drawings, or as specified, and where ordered by the Engineer for miscellaneous backfill.

### IV.3. GRANULAR BACKFILL

IV.3.1. In lieu of the above specified AASHTO Class A-3 soil material for backfill and bedding, the Contractor may use granular backfill as specified hereinafter, if approved by the Engineer.

IV.3.2. Granular backfill shall consist of well-graded crushed stone or crushed gravel meeting the requirements of ASTM Designation C33, Gradation 67 (3/4 inch to No. 4). Air cooled blast furnace slag, alone or in combination with crushed stone and/or crushed gravel, conforming to ASTM Designation C33, may also be used.

### IV.4. FLOWABLE FILL

Flowable fill shall be in accordance with FDOT specification section number 121 (latest version), unless approved otherwise by JEA. The use of chemicals to accelerate the curing time may be utilized at the contractor's option.

#### IV.4.1. MIX DESIGN

Flowable Fill is a mixture of Portland cement, fly ash, fine aggregate, air entraining admixture and water. Flowable fill contains a low cementitious content for reduced strength development. Submit mix designs to the JEA Engineer for approval. The following are suggested mix guides for excavatable and non-excavatable flowable fill. Non-excavatable flowable fill shall be utilized in filling abandoned mains and structure. Excavatable flowable fill shall be utilized around active (in-use) mains and structures.

	EXCAVATABLE	Non-EXCAVATABLE
Cement Type	75 – 100 lb/yd <sup>3</sup> [45 – 60 kg/m <sup>3</sup> ]	75 – 150 lb/yd <sup>3</sup> [45 – 90 kg/m <sup>3</sup> ]
Fly Ash	None	150 – 600 lb/yd <sup>3</sup> [90 – 355 kg/m <sup>3</sup> ]
Water	*	*
Air**	5 – 35%	5 – 15%
28 Day Compressive Strength**	Maximum 100 psi [690 kPa]	Minimum 125 psi [860 kPa]
Unit Weight (Wet)**	90 – 110 lb/yd <sup>3</sup> [1,440 – 1,760 kg/m <sup>3</sup> ]	100 – 125 lb/yd <sup>3</sup> [1,600 – 2,000 kg/m <sup>3</sup> ]

\* Mix designs shall produce a consistency that will result in a flowable self-leveling product at time of placement.

\*\* The requirements for percent air, compressive strength and unit weight are for laboratory designs only and are not intended for jobsite acceptance requirements.

\*\*\*Fine Aggregate shall be proportioned to yield 1 yd<sup>3</sup> [1 m<sup>3</sup>].

# *JEA Water and Wastewater Standards*

## *408 Excavation and Earthwork*

### **IV.4.2. CONSTRUCTION REQUIREMENTS**

Use straps, soil anchors or other approved means of restraint to ensure correct alignment when flowable fill is used as backfill for pipe or where flotation or misalignment may occur. Place flowable fill to the designated fill line without vibration or other means of compaction. Do not place flowable fill during inclement weather, e.g. rain or ambient temperatures below 40°F [4°C]. Take all necessary precautions to prevent any damages caused by the hydraulic pressure of the fill during placement prior to hardening. Provide the means to confine the material within the designated space.

### **V. BACKFILL – STRUCTURES**

Backfilling shall be accomplished as soon as practical after underground work on the structure is completed. No trash shall be allowed to accumulate in the space to be backfilled. Particular care shall be taken to avoid leaving wood where it will be buried. The space to be backfilled shall be well cleaned before backfilling commences. Ground surface shall be restored to the elevation shown on the plans.

### **VI. COMPACTION AND DENSITY**

Backfill and compaction shall be conducted to achieve densities as specified herein. Methods for backfill placement and compaction shall be subject to approval by the Engineer. Compaction “under paving” shall refer to installations immediately under paving and also to installations within a plane described as 1 (horizontal) to 1 (vertical) slope downward from the edge of roadway or back of curb.

#### **VI.1. COMPACTION IN CITY OF JACKSONVILLE RIGHT-OF-WAYS AND IN ALL EASEMENTS**

##### **VI.1.1. ON FILL BELOW PIPE/STRUCTURES**

Where pipe is laid or structures built on fill materials in lieu of undisturbed earth, backfill material up to the bottom of pipe or structures shall be placed in 6 inch compacted thickness layers and shall be compacted to 95% of its maximum density as determined by the Laboratory Modified Proctor Test, ASTM D1557. Density testing shall be made on every compacted lift and at grade, located at 150 foot intervals and at every structure.

##### **VI.1.2. UNDER PAVING, UP TO 1 FOOT OVER TOP OF PIPE/BOTTOM OF STRUCTURE**

Backfill material up to a level 1 foot over the top of pipe or bottom of structures shall be placed in 6 inch compacted thickness layers and shall be compacted to 98% of its maximum density as determined by the Laboratory Modified Proctor Test, ASTM D1557. Density testing shall be made on every compacted lift and at grade, located at 150 foot intervals and at every structure.

##### **VI.1.3. UNDER PAVING, OVER 1 FOOT FROM TOP OF PIPE/BOTTOM OF STRUCTURE TO GRADE**

Backfill material from 1 foot over the top of the pipe or bottom of structures to finished grade shall be placed in layers not to exceed 12 inches compacted thickness and shall be compacted to 95% of maximum density as determined by the Laboratory Modified Proctor Test, ASTM D1557. Density testing shall be made on every compacted lift and at grade, located at 150 foot intervals and at every structure.

##### **VI.1.4. NOT UNDER PAVING, UP TO 1 FOOT OVER TOP OF PIPE/BOTTOM OF STRUCTURE**

Backfill material up to a level 1 foot over the top of pipe or bottom of structures shall be placed in 6 inch compacted thickness layers and shall be compacted to 98% of its maximum density as determined by the Laboratory Modified Proctor Test, ASTM D1557. Density testing shall be made

# ***JEA Water and Wastewater Standards***

## ***408 Excavation and Earthwork***

on every compacted lift and at grade, located at 3000-foot intervals, at road crossings, at 20% of all manholes/structures and at 3 random locations as determined by the JEA Inspector.

### **VI.1.5. NOT UNDER PAVING, OVER 1 FOOT FROM TOP OF PIPE/BOTTOM OF STRUCTURE TO GRADE**

Backfill material from 1 foot over the top of the pipe or bottom of structures to finished grade shall be placed in 12-inch compacted thickness layers and shall be compacted to match existing conditions but not less than 95% of its maximum density as determined by the Laboratory Modified Proctor Test, ASTM D1557. Density testing shall be made on every compacted lift and at grade, located at 3000 foot intervals, at road crossings, at 20% of all manholes/structures and at 3 random locations as determined by the JEA Inspector.

## **VI.2. COMPACTION IN NEW SUBDIVISIONS**

### **VI.2.1. UP TO 1 FOOT OVER TOP OF PIPE/BOTTOM OF STRUCTURE**

Backfill material up to a level 1 foot over the top of pipe or bottom of structures shall be placed in 6 inch compacted thickness layers and shall be compacted to 98% of its maximum density as determined by the Laboratory Modified Proctor Test, ASTM D1557. Density testing shall be made on every compacted lift and at grade, located at 150 foot intervals and at every structure for the first 600 feet. If the density testing meets these density requirements and the contractor does not change the method of placing and compacting, the remaining density testing shall be at 3000 foot intervals, at road crossings, at 20% of all manholes/structures and at 3 random locations as determined by the JEA Inspector.

### **VI.2.2. OVER 1 FOOT FROM TOP OF PIPE/BOTTOM OF STRUCTURE TO GRADE**

Backfill material from 1 foot over the top of the pipe or bottom of structures to finished grade shall be placed in 12 inch compacted thickness layers and shall be compacted to match existing conditions but not less than 95% of its maximum density as determined by the Laboratory Modified Proctor Test, ASTM D1557. Density testing shall be made on every compacted lift and at grade, located at 150 foot intervals and at every structure for the first 600 feet. If the density testing meets these density requirements and the contractor does not change the method of placing and compacting, the remaining density testing shall be made on every compacted lift and at grade located at 3000 foot intervals, at road crossings, at 20% of all manholes/structures and at 3 random locations as determined by the JEA Inspector.

## **VI.3. COMPACTION IN STATE ROAD RIGHT-OF-WAY**

### **VI.3.1. ON FILL BELOW PIPE/STRUCTURES**

Where pipe is laid or structures built on fill materials in lieu of undisturbed earth, backfill material up to the bottom of pipe or structures shall be placed in 6-inch compacted thickness layers and shall be compacted to 100% of its maximum density as determined by the Laboratory Standard Proctor Test, ASTM D698. Density testing shall be made on every compacted lift and at grade, located at 150 foot intervals and at every structure.

### **VI.3.2. UNDER PAVING, UP TO 1 FOOT OVER TOP OF PIPE/BOTTOM OF STRUCTURE**

Backfill material up to a level 1 foot over the top of pipe or bottom of structures shall be placed in 6-inch compacted thickness layers. Density testing shall be made on every compacted lift and at grade, located at 150-foot intervals and at every structure.



# ***JEA Water and Wastewater Standards***

## ***408 Excavation and Earthwork***

### **VI.3.3. UNDER PAVING, OVER 1 FOOT FROM TOP OF PIPE/BOTTOM OF STRUCTURE TO GRADE**

Backfill material from 1 foot over the top of the pipe or bottom of structures to finished grade shall be placed in layers not to exceed 12 inches compacted thickness. Density testing shall be made on every compacted lift and at grade, located at 150 foot intervals and at every structure.

### **VI.3.4. NOT UNDER PAVING, UP TO 1 FOOT OVER TOP OF PIPE/BOTTOM OF STRUCTURE**

Backfill material up to a level 1 foot over the top of pipe or bottom of structures shall be placed in 6 inch compacted thickness layers. Density testing shall be made on every compacted lift and at grade, located at 500 foot intervals, at road crossings, at 20% of all manholes/structures and at 3 random locations as determined by the JEA Inspector.

### **VI.3.5. NOT UNDER PAVING, OVER 1 FOOT FROM TOP OF PIPE/BOTTOM OF STRUCTURE TO GRADE**

Backfill material from 1 foot over the top of the pipe or bottom of structures to finished grade shall be placed in 12-inch compacted thickness layers. Density testing shall be made on every compacted lift and at grade, located at 500-foot intervals, at road crossings, at 20% of all manholes/structures and at 3 random locations, as determined by the JEA Inspector.

### **VI.3.6. CONFLICT WITH FLORIDA D.O.T. STANDARDS**

If a conflict exists between the Florida D.O.T. Standard Specifications for Road and Bridge Construction and this specification, the more stringent requirement shall apply.

### **VI.3.7. COMPACTION OF BACKFILL FOR PIPE TRENCHES**

Pipe backfill densities of 100% of the Standard Proctor maximum density as determined by AASHTO T99, Method C shall be required except where the cover height 1) below the bottom of base under asphalt pavement, 2) below concrete pavement, or 3) below unpaved ground, exceeds 15 inches, then pipe backfill densities of at least 95% of the Standard Proctor maximum density (as determined by AASHTO T99, Method C) shall be required.

### **VI.3.8. DENSITY REQUIREMENT FOR DRAINAGE STRUCTURES**

For density requirements around drainage structures, obtain a minimum quality control density (in any one lift of backfill material placement) of 100% of the Standard Proctor maximum density as determined by AASHTO T99 for a distance of one pipe diameter but not less than 3 feet from the outside face of the structure.

## **VI.4. COMPACTION IN RAILROAD RIGHT-OF-WAY**

All backfill operations within the railroad right-of-way shall be placed in 8- inch maximum layers, loose measure, and thoroughly tamped with mechanical tampers to 98% of its maximum density as determined by the Laboratory Modified Proctor Test, ASTM D1557. Density testing shall be made on every compacted lift and at grade, located at 150 foot intervals and at every structure. If a conflict exists between the Railroad's Specification and this specification, the more stringent requirement shall apply.

## **VI.5. COMPACTION METHOD**

The method of compacting backfill material shall be the contractor's option provided the compaction requirements herein before specified are obtained. If tests for in-place density consistently fail to meet the requirements, the engineer may require the contractor to change its method of compaction without claiming additional compensation. Compaction by flooding will not be allowed except with written authorization by the engineer.

# *JEA Water and Wastewater Standards*

## *408 Excavation and Earthwork*

### **VI.6. MOISTURE CONTENT**

The material shall be compacted at a moisture content such that the specified density can be attained. If necessary to attain the specified density, add water to the material, or lower the moisture content by manipulating the material or allowing it to dry.

### **VI.7. TESTING**

VI.7.1. The contractor shall retain an independent testing laboratory to make in-place density tests of excavation backfill as specified herein and as located by the engineer or JEA representative.

VI.7.2. Structure excavations shall require one test as located by the engineer or JEA representative, for each compacted lift and one test at grade. If perimeter of structure exceeds 50 feet, additional tests shall be required for each compacted lift at 50-foot intervals around perimeter.

VI.7.3. Density test reports shall be submitted to the engineer and the JEA representative for approval, in duplicate, within 72 hours of the test. Test reports shall be transmitted directly from the laboratory to the engineer and the JEA. Test reports shall be identified by the project title, project number, project location and location and depth of each on-site test submitted.

VI.7.4. Placing permanent construction over fill that has not been tested and approved may require the contractor to remove permanent work, re-compact the fill and replace the work at the contractor's expense.

VI.7.5. Any failed test shall be re-tested at the contractor's expense.

### **VI.8. BACKFILL MAINTENANCE**

The Contractor shall refill settlement in all backfilled areas. The surfaces of backfilled areas shall be maintained in a safe and satisfactory condition at all times until the expiration of the two year warranty period.

### **VII. DUST CONTROL**

If, in the opinion of the Engineer, it is necessary to control dust from time to time during the progress of the work, the Contractor shall do so with no additional compensation.

### **VIII. SEWAGE SPILLS**

JEA recognizes that sewage may be released from pipes in the course of performing the work. Contractor shall minimize the amount of sewage released into excavations by notifying affected parties (homeowners or businesses) of the service interruption, pre-draining affected lines, ensuring pump station (non) operating status, etc. Contractor shall take precautions to prevent sewage from contacting the ground. If sewage contacts the ground, contractor shall take appropriate measures to disinfect the affected area where the sewage release occurred. When pooling sewage is observed, contractor shall vacuum remove the sewage or remove the sewage by other means acceptable to the JEA inspector and dispose of the sewage in accordance with environmental and public health regulations. This can include pumping to the nearest available sanitary manhole. Sanitary systems found plugged due to this type of pumping activity shall be cleaned at the contractor's expense. Contractor shall inform the JEA inspector of spills which contact the ground estimated to be in excess of five (5) gallons. Spills less than five gallons, which contact the ground, shall be noted in the contractor's field log book. Notification of the inspector does not mitigate contractor's responsibility to take corrective action. If JEA is fined as a result of a sewage spill associated with the work, JEA will require contractor to reimburse JEA for the fine amount.

*Blank Page*

## **436 – NONFERROUS METALWORK**

### **I. SCOPE OF WORK**

The work under this section shall include the furnishing, fabrication, delivery and erection of all miscellaneous nonferrous metalwork as indicated on the drawings and specified in this section. All referenced to industry standards (ASTM, ANSI, etc.) shall be to the latest revision unless otherwise stated.

### **II. GENERAL REQUIREMENTS**

Aluminum work shall be fabricated of plates and rolled or extruded shapes conforming (unless otherwise approved) to the following alloy designations of The Aluminum Company of America:

- Rolled shapes           6061-T6
- Extruded shapes       6063-T5
- Smooth plates           6061-T6
- Gratings                 6061-T6
- Sheet                     3003

#### **II.1. WORKMANSHIP**

Aluminum shall be well formed to shape and size with sharp lines and angles. Shearing and punching shall leave clean, true lines and surfaces. Permanent connections shall be welded or riveted. The workmanship shall conform to the best practice and shall be subject to the approval of the Engineer. Where welding is used, it shall conform to the current requirements of the American Welding Society for the applicable type of work.

#### **II.2. SHOP AND ERECTION DRAWINGS**

The Contractor shall submit, for approval, completely detailed and certified shop and erection drawings of the miscellaneous nonferrous metalwork. Such drawings shall show the alloy and temper to be used; the finish, if any, to be applied; and the nature and location of all coating or other protection against corrosion to be applied at the shop or in the field.

#### **II.3. RESPONSIBILITY FOR DIMENSIONS**

The general dimensions and details of the aluminum work are indicated on the drawings, but the Contractor shall be responsible for the correctness of the dimensions and details and shall carefully check the same in order to avoid possible error.

### **III. ALUMINUM**

#### **III.1. ALUMINUM NOSINGS**

Abrasive aluminum treads, saddles and nosings shall be of the size and contour indicated, not less than 3/8 inch thick and shall be equipped with suitable anchors. Exposed parts of adjacent nosings and thresholds shall match in contour and texture.

#### **III.2. ALUMINUM GRATINGS AND FRAMES**

Gratings shall be serrated, extruded type. Deflection shall be no greater than specified for aluminum checkered plates and frames in subparagraph 9.

# *JEA Water and Wastewater Standards*

## *436 Nonferrous Metalwork*

- III.2.1. The gratings shall be fabricated in easily removable sections but securely attached to supports. Frames for gratings in concrete shall have mitered corners, with welded joints ground smooth where exposed, and welded anchors.
- III.2.2. The tread surfaces of all main bars shall have a nonskid surface. All openings for fixtures or pipe which require the cutting of three main bars or more, shall be finish banded. Discontinuous edges shall also be banded.
- III.2.3. Frames set in concrete shall be placed as the concrete is being poured.

### **III.3. ALUMINUM RAILINGS**

Aluminum railings shall be fabricated, as indicated on the drawings.

- III.3.1. Unless otherwise indicated, stanchions and rails shall be 1½ inch diameter, iron pipe size, extra heavy weight aluminum pipe for stanchions and standard weight for rails of 6063t832 alloy and temper. Railings shall be fabricated in sections as large as practicable, and joints between sections shall be made in a neat and inconspicuous manner as approved. Aluminum railings shall have welded joints using aluminum alloy 5056 welding rod. All exposed welds shall be ground smooth.
- III.3.2. The aluminum handrails shall receive an applied alumilite finish.

### **III.4. ALUMINUM CHECKERED PLATES, FRAMES AND COVERS**

- III.4.1. Aluminum checkered plates, frames and covers shall be designed to carry a live uniform load of 300 pounds per square foot with a factor of safety of 5 based on the ultimate strength of the material and be suitably reinforced to prevent deflections greater than 1/160 of the span. Plates shall have an approved nonskid surface with approved flush lift rings or handholes, as indicated.
- III.4.2. Covers and plates shall be made to fit into the frames neatly and accurately. Hinges shall be heavy-duty, stainless steel with removable stainless steel pins. The butts shall be fastened to the covers and frames with stainless steel rivets or by welding.
- III.4.3. Frames shall have mitered corners with welded joints ground smooth where exposed, and welded anchors. Frames shall be built into the concrete as the concrete is being placed.
- III.4.4. All holes necessary to be drilled in place shall be ground smooth.

## **IV. OTHER ITEMS**

Other items of miscellaneous nonferrous metalwork not particularly specified shall be of the shape, size, details and finish indicated on the drawings or suitable for the purposes specified (as approved).

## **V. PROTECTION**

Surfaces of aluminum which receive an approved finish, and other items of decorative aluminum, shall be given two shop coats of methacrylate protective lacquer. Protective coatings of lacquer worn off due to handling or erection shall be replaced by new coatings of lacquer of the same type.

### **V.1. COATING REQUIRED**

Aluminum surfaces which, after erection, would otherwise be in contact with concrete or brick masonry shall be protected from contact therewith by a coat of approved primer. Areas where w-3 coating has been

# *JEA Water and Wastewater Standards*

## *436 Nonferrous Metalwork*

damaged by abrasion or other cause shall be cleaned and recoated so that the aluminum will have a complete, protective paint film when brought into contact with the material against which it is being protected.

### **V.2. COATING PREPARATION**

Before application of the coating, the surface shall be cleaned free of all dirt, heavy deposits of grease or oil, and other foreign substances immersed in or swabbed with a solution of phosphoric acid and organic solvents such as deoxidine no. 670, sol-klean no. 110-3, or oakite no. 35, diluted with water in the ratio of 1:3 and then rinsed with clear water and thoroughly dried. The cleaning solution shall be at a temperature between 50° f and 90° f and shall remain in contact with the metal (without being allowed to dry) for at least five minutes. On sections more than 1/8 inch thick a mild sandblast may be used in lieu of the solution-rinsing procedure specified above.

### **V.3. DISSIMILAR METALS**

Where aluminum is to be used in connection with dissimilar metals, suitable insulation, such as impregnated roofing felt, shall be provided between contact surfaces so as to eliminate direct contact and the resultant electrolysis, or the aluminum surface shall be cleaned and painted with the coatings specified above.

## **VI. CLEANING**

After aluminum has been erected, it shall be cleaned by use of a mild soap and water, followed by a clear water rinse.

*Blank Page*

## **437 - CONCRETE WORK**

### **I. SCOPE OF WORK**

The scope of work under this section includes all materials, equipment and labor, and performing all operations for constructing the concrete work as shown on the drawings, called for herein, or necessary for the proper completion of the work. The work shall be performed in accordance with these specifications and to the lines, notes, and dimensions indicated on the drawings or specified herein. All references to industry standards (ASTM, ANSI, etc.) shall be to the latest revision unless otherwise stated.

### **II. GENERAL REQUIREMENTS**

All concrete shall be proportioned, mixed, placed, finished and cured in accordance with the requirements of Standard Specifications of the American Concrete Institute, ACI 301-66, as modified herein, except that concrete for pavement replacement, including sidewalks, driveways and curb and gutter, shall be placed, finished and cured in accordance with ACI 617-58.

### **III. MATERIALS**

All concrete shall be ready-mixed, normal weight, as produced by a plant acceptable to the Engineer. Job mixed concrete may be used for small quantities upon specific approval of the Engineer.

#### **III.1. CEMENT**

- III.1.1. Cement shall be a single brand of Portland cement conforming to the ASTM standard specifications for Portland cement, designation C150, for Type I cement, Type II cement, or Type III (high-early-strength) cement. Air entraining cement shall not be used. If no type cement is specified, type I shall be used. Type III (high-early-strength) cement may be used only with the written permission of the engineer, but no additional payment will be made to the contractor for the use thereof.
- III.1.2. In addition to the requirements of the above mentioned specifications, cement to be used in exposed concrete shall exhibit no efflorescence when tested in accordance with the ASTM standard methods of sampling and testing brick, designation c-67, but employing 2 inch x 7 inch x 1/2 inch mortar slabs, comprising a 1:3 mixture by weight of the cement in question and Ottawa sand, mixed with local tap water to a flow of 100 percent and aged one week before test.
- III.1.3. All cement to be used in the work shall be subject to testing to determine whether it conforms to the requirements of these specifications. The methods of testing shall conform to the appropriate specification, but the place, time, frequency, and method of sampling will be determined by the engineer in accordance with the particular conditions of this project. Cement which is partially set or which is lumpy or caked shall not be used, and the entire contents of the sack of cement or the container of bulk cement which contains damages, partially set, or lumps of caked cement will be rejected for use.
- III.1.4. If required, the contractor shall furnish sworn certificates of mill tests of cement, in triplicate, at least 7 days before the cement will be used. JEA reserves the right to make such independent tests as he may deem necessary at any time.

#### **III.2. AGGREGATES**



# *JEA Water and Wastewater Standards*

## *437 Concrete Work*

- III.2.1. Fine aggregate shall be washed sand; clean, sound, sharp, screened and well-graded with no grain larger than will pass a no. 4 sieve. No less than 15 percent are more than 30 percent by weight shall pass a no. 50 sieve. No fine aggregate shall be used if it contains more than 2 percent of silt or which shows a color darker than plate 2 when tested according to the ASTM standard method of test for organic impurities in sands for concrete, designation C40.
- III.2.2. Coarse aggregate shall be washed, hard, tough and durable screened gravel or crushed stone having not more than 5% by weight of deleterious substances and soft fragments. Aggregate shall be well graded from the largest which shall pass a 1 inch mesh to the smallest which shall pass a 3/8 inch mesh and be retained by a 1/4 inch mesh. No coarse aggregate shall be used if it contains more than 1 percent of silt or which shows a color darker than plate i when tested as above specified for fine aggregate.
- III.2.3. Both fine and coarse aggregate shall conform to the requirements of ASTM standard specification C33. The contractor shall submit clearly labeled samples of aggregates to the engineer when requested.

### **III.3. ADMIXTURES**

- III.3.1. Admixtures causing accelerated setting of cement in concrete shall not be used.
- III.3.2. The particular admixture to be used shall meet with the approval of the engineer. Recognized and approved admixtures are located in the JEA Water, Reclaimed Water and Wastewater Approved Materials Manual.

### **III.4. WATER**

The water for concrete shall be clean, fresh, and free from injurious amounts of oil, acid alkali, organic matter, or other deleterious substances.

### **III.5. CONCRETE PROPORTIONING**

Materials shall be proportioned in accordance with ACI-613. Air content, determined in accordance with ASTM C173, shall be 5% (+/- 1%) by volume. Slump Shall Be As Listed Below:

- Class A 2 1/2, +/- 1 inch
- Class B 3, +/- 1 inch
- Class C 3 1/2, +/- 1 1/2 inch

Concrete shall be of plastic consistency such that it can be worked readily into all parts of the forms and around embedded work without segregation of constituent materials or collection of free water on the surface. Cement, fine aggregate, coarse aggregate, and water for concrete shall be measured separately and with accuracy.

### **III.6. PLANT APPROVAL**

The Engineer shall have the right to inspect the plant of the manufacturer and the proportioning and mixing of the concrete. The materials method of proportioning, mixing, and delivering are to be satisfactory and in accordance with the above specifications. The manufacturer shall furnish, from an independent testing laboratory and through the Contractor, appropriate certificates of tests, materials, proportions, mixing and strengths if requested by the engineer.

### **III.7. MIXING AND DELIVERY**

# *JEA Water and Wastewater Standards*

## *437 Concrete Work*

The quantity of concrete to be mixed or delivered in any one batch shall not exceed the rated capacity of the mixer or agitator as stated on the nameplate for the type of mixer in use. Attention is directed to the importance of dispatching trucks from the batching plant so that they shall arrive at the site of the work just before the concrete is required, thus avoiding excessive mixing of concrete while waiting. Concrete shall be discharged into forms within 1½ hours after water was first added to the mix, and shall be mixed at least 5 minutes after all water has been added.

### **III.8. QUALITY**

Concrete for slabs on grade (not tank bottoms) shall have a compressive strength of not less than 3,000 psi at 28 days; concrete for fill shall have compressive strength of not less than 2,500 psi at 28 days; concrete for all other work shall have compressive strength of not less than 4,000 psi at 28 days. Concrete of 4,000 psi strength shall be designated Class "A", 3,000 psi concrete shall be designated Class "B", and 2,500 psi concrete shall be designated Class "C".

### **III.9. REINFORCING STEEL**

Concrete reinforcement in sizes no. 3 (3/8 inch) and larger shall be deformed steel bars of the shapes and sizes indicated on the drawings.

- III.9.1. Deformations shall conform to ASTM Tentative Specifications for Minimum Requirements for the Deformations of Deformed Steel Bars for Concrete Reinforcement, Designation A305.
- III.9.2. The steel shall be newly rolled stock, substantially free from mill scale, rust, dirt, grease, or other foreign matter. Bars shall be domestic billet steel or rail steel.
- III.9.3. Billet steel bars shall be intermediate grade conforming to the ASTM Tentative Specifications for Concrete Reinforcement, Designation A615.
- III.9.4. Rail steel bars, if used, shall conform to ASTM Tentative Specifications for Rail Steel Bars for Concrete Reinforcement, Designation A16. In the case of rail steel bars, the bars shall be re-rolled by an approved mill. If requested by the engineer, the Contractor shall submit at his expense certified copies of tests of rail steel bars furnished. The tests shall be as specified in the appropriate ASTM Specifications above referred to, and shall be made by an approved laboratory. To be accepted for use, the bars shall show an elongation of at least 8 inches as required by the ASTM Specifications, but not less than 10.5 %.
- III.9.5. If requested by the engineer, the contractor shall submit for approval shop drawing submittals for cutting and bending drawings and schedules for all reinforcement furnished.
- III.9.6. Reinforcement shall be accurately formed to the dimensions indicated on the drawings. Stirrups and tie bars shall be bent around a pin having a diameter not less than two times the minimum thickness of the bar. Bends for other bars shall be made around a pin having a diameter not less than six times the minimum thickness except for bars larger than 1 inch in which case the bends shall be made around a pin of eight bar diameters. All bars shall be bent cold. Bars shall be shipped to the project site fastened in bundles of the same size and shape, with identification tags, giving size and mark, securely attached thereto.
- III.9.7. Before being placed in a position, reinforcement shall be thoroughly cleaned of loose mill and rust scale, dirt, and other coatings, including ice, that reduce or destroy bond. Where there is delay in

# *JEA Water and Wastewater Standards*

## *437 Concrete Work*

depositing concrete after reinforcement is in place, bars shall be re-inspected and cleaned when necessary.

- III.9.8. Reinforcement shall be accurately positioned as indicated on the drawings, and secured against displacement by using annealed iron wire ties or suitable clips at intersections. Bar splices, laps, etc., shall be as called for on the drawings, or if not called for, laps shall be not less than 24 times the nominal diameter of the bar. Wire mesh sheets shall have a side lap of not less than 2 inches and an end lap of not less than 6 inches. Concrete blocks having a minimum bearing area of 2 inches by 2 inches and equal in quality to that specified for the slab shall be used for supporting spacers, or hangers may be used. Wood blocks, stones, brick chips, etc., shall not be used to support reinforcement.
- III.9.9. Reinforcement which is to be exposed to the atmosphere for a considerable length of time after having been placed shall be painted with a heavy coat of cement grout, if required by the Engineer.

### **III.10. EMBEDDED ITEMS**

- III.10.1. All sleeves, inserts, hangers, anchor bolts, dowels, nailing strips, or other embedded items, shall be accurately set, and firmly held in place while the concrete is deposited. Anchors and ties for masonry shall be provided as shown on the drawings or called for in the masonry specifications.
- III.10.2. Pipes, conduits and other items embedded in the concrete shall be so placed and held that they do not misplace the reinforcing or weaken the concrete at points of maximum stress or where the concrete section is not sufficient to permit the reduction of area caused by the embedment.

## **IV. INSTALLATION**

### **IV.1. FORMS**

- IV.1.1. Forms shall be securely braced, substantial and unyielding, and of sufficient strength to hold the concrete without bulging between supports, or without other deviation from the neat lines as shown on the plans. Forms shall be mortar-tight and shall be constructed of dressed lumber of uniform thickness, with or without a form liner.
- IV.1.2. The spacing of joints and wales shall be such as to prevent warp and bulging and to produce true and accurate surfaces. All lumber shall be free from knot holes, loose knots, cracks, splits, warps, or other defects affecting its strength or the appearance of the finished concrete surface. Fiberboard or other artificial lumber, approved by the engineer, may be used as a lining for forms.
- IV.1.3. The interior surfaces of forms shall be adequately oiled, greased or soaped, to prevent adhesion of mortar. Form oil for exposed work shall be non-staining. Before placing of concrete, the forms shall be cleaned of all dirt, saw dust, shavings or other debris, and the surfaces shall be dampened.
- IV.1.4. Special care shall be exercised to secure smooth and tight-fitting forms which can be rigidly held to line and grade and removed without injury to the concrete. All corners in the finished work shall be true, sharp and clean-cut. Alignment of forms and grade of top chamfer strips shall be checked immediately after the placing of concrete in the forms.

# *JEA Water and Wastewater Standards*

## *437 Concrete Work*

- IV.1.5. Forms shall not be removed until the product of the elapsed number of days after placement and the average daily air temperature at the surface of the concrete equals 100 for walls and vertical surfaces and 500 for slabs.
- IV.1.6. Shores under beams and slabs shall not be removed until the concrete has attained at least 60 percent of the specified cylinder strength and also sufficient strength to safely support its own weight and the construction live loads upon it. Shores under cantilevers shall remain in place at least 14 days after concrete is placed.

### **IV.2. CONCRETE PLACEMENT**

- IV.2.1. All concrete shall be placed during daylight hours allowing sufficient time for adequately finishing the concrete surfaces during daylight hours unless approved by JEA representative for night time construction. No concrete shall be placed until the forms have been approved by the engineer and until all the reinforcement is in place and has been inspected and approved by the engineer. No concrete shall be placed in water, and forms shall be free from water, dirt, debris, or any foreign matter when concrete is placed. Normal weather limitations for placing concrete shall be adhered to and no concrete shall be exposed to the action of water before final setting.
- IV.2.2. The method and manner of placing concrete shall be such as to avoid the possibility of segregation or separation of the aggregates. If the quality of concrete as it reaches its final position is unsatisfactory, the concrete as placed shall be discontinued or adjusted until the quality of the concrete as placed is satisfactory. Open troughs or chutes shall be of metal or metal-lined. Where steep slopes are required the chutes shall be equipped with baffles or shall be in short lengths that reverse the direction of movement. Where placing operations would involve dropping the concrete freely more than five feet, it shall be deposited through pipes, sheet metal or other approved material. Troughs, chutes or pipes with a combined length of more than 30 feet shall be used only on written authority from the engineer. All troughs, chutes and pipes shall be kept clean and free from coatings or hardened concrete by being thoroughly flushed with water after each run, or in its final position. Depositing a large quantity at any point and running or working it along the forms shall not be done. Special care shall be taken to fill each part of the forms and to work the coarse aggregate back from the face and to force the concrete under and around the reinforcing bars without displacing them. The concrete consistency as measured by slump shall be as specified above.
- IV.2.3. Concrete shall be compacted by continuous working with a suitable tool in an acceptable manner and by vibrating. Vibration shall be done by experienced operators under close supervision and the duration shall be held to a minimum necessary to produce thorough compaction without segregation. Where vibrators are not used all thin section work shall be thoroughly worked with a steel slicing rod. All faces shall be well spaded and the mortar flushed to the surface by continuous working with a concrete spading implement.
- IV.2.4. In all cases where, on account of the obstructions produced by reinforcing metal, shapes or forms, or any other uncontrollable condition, difficulty is encountered in puddling the concrete adjacent to the forms, the mortar content of the mix shall be brought into proper contact with the interior surfaces by vibrating the forms. The vibrations shall be produced by striking the outside surfaces of the forms with wooden mallets or by other means satisfactory to the engineer.

### **IV.3. TEST SPECIMENS**

# *JEA Water and Wastewater Standards*

## *437 Concrete Work*

If required by JEA, for each class of concrete, one set of three cylinders shall be made by the Testing Laboratory selected by JEA for each day's placement of concrete but not less than one specimen for each 150 cu. yd. One of these cylinders shall be tested at the age of 7 days, and one at the age of 28 days, to determine the quality of concrete obtained. The costs for performing such tests will be paid for by JEA when the test results are in conformity with these specifications. However, those which show no conformity or a failure will be paid for by the contractor. It shall be the responsibility of the contractor to properly inform the Testing Laboratory as to when concrete will be placed into the forms.

#### **IV.4. WATER STOPS**

Water stops shall be furnished where shown on the drawings and shall be furnished in the longest lengths possible. They shall be rigidly supported and accurately positioned with the center at the joint interface. All water stops shall be approved 5 inch polyvinyl chloride at the dumb-bell, or ribbed type, and a minimum of 3/16 inch thick. They shall be continuous along the concrete joint. Ends and corners shall be spliced to provide water tightness.

#### **IV.5. CURING & PROTECTION**

IV.5.1. All concrete work shall be protected against damage from the elements and defacement of any nature during construction operations.

IV.5.2. Water shall not be permitted to rise on concrete within 2 hours after it is placed, nor shall running water be allowed to flow over completed concrete within 4 days after it has been placed.

IV.5.3. All concrete, particularly slabs and including finished surfaces, shall be treated immediately after concreting or cement finishing is completed to provide continuous moist curing for at least 7 days, regardless of the adjacent air temperature. Walls and vertical surfaces may be covered with continuously saturated burlap, or kept moist by other approved means. Horizontal surfaces, slabs, etc., shall be ponded to a depth of 1/2 inch wherever practicable, or kept continuously saturated wet by the use of lawn sprinklers, a complete covering of continuously saturated burlap, or by other approved means. Except on surfaces to which additional coatings or materials are to be bonded, the contractor may, at his option, use an approved membrane curing compound in lieu of water curing of concrete. The compound shall be delivered to the job in the manufacturer's containers and shall be applied in strict accordance with the manufacturer's printed instructions.

IV.5.4. Curing compound for exposed surfaces shall be non-staining.

IV.5.5. For at least 7 days after having been placed, all concrete shall be so protected that the temperature at the surface will not fall below 50 degrees f.

IV.5.6. No manure, salt, or other chemicals shall be used for protection.

IV.5.7. The above mentioned 7-day period may be reduced to 3 days in each case if high-early- strength cement is used in the concrete.

IV.5.8. Wherever Practical, Finished Slabs Shall Be Protected From The Direct Rays Of The Sun To Prevent Checking And Cracking.

IV.5.9. When the temperature is below 40 degrees Fahrenheit, or predicted to go below 36 degrees in the next 24 hours, or predicted to go below 32 degrees in the next 72 hours, no concrete shall be poured without the express permission of the Engineer. Permission so granted shall be for the day

# *JEA Water and Wastewater Standards*

## *437 Concrete Work*

and location only and must again be requested on subsequent days when temperatures are as stated above. The use of chemicals in the concrete mix to reduce temperature of freezing will not be permitted.

### **IV.6. FINISHING**

- IV.6.1. Strike off concrete surfaces to elevations and profiles indicated, and finish with wood or cork float as hereinafter specified, even and true, free from cracks, pockets, or other imperfections. Discontinue as soon as water appears on surface. Finished concrete, except at warped surfaces, shall be such that irregularities shall not exceed 1/4 inch as measured by a 10 foot straight edge.
- IV.6.2. Following removal of forms, thoroughly wet all surfaces to remain exposed. Fill all honeycombs, tie rod holes and areas damaged in form removal with grout composed of one part portland cement to two parts sand, with water as required, and rub with abrasive stones to a smooth, uniform surface.
- IV.6.3. Any work not formed as indicated on drawings or that is out of alignment or level or shows a defective surface shall be corrected in a manner satisfactory to the Engineer.
- IV.6.4. It is expected that forms, concrete and workmanship shall be such that the quantity of trimming and repair work is kept to a minimum.

### **IV.7. BONDING AGENT**

Where new concrete is to be placed against existing concrete, the existing concrete surface shall be coated with a bonding agent prior to placing new concrete. Application shall be in strict accordance with manufacturer's recommendations.

*Blank Page*

## **441 - GRASSING**

### **I. GENERAL**

All grassed areas that are disturbed or damaged by the construction operation shall be restored by re-sodding or seeding and mulching after fill has been graded to meet the existing contours. Sod shall be similar to the type of grass in place and shall be fresh, live and well rooted. Areas to be seeded and mulched shall be agreed upon and approved by the Engineer prior to excavation. The heavy, firm root structure of the sod shall be placed level with adjacent concrete structures (i.e.; sidewalks, driveways & curb and gutter) so that no drop-off results between the two surfaces. Unless approved otherwise by JEA, the sodded areas shall be uniform level and smooth without dips or holes.

### **II. SCOPE OF WORK**

The work under this section includes the furnishing of all labor, material, equipment, and supervision required to grade, and install sod and grass in all areas shown on the Contract Drawings or specified herein.

### **III. SEEDING AND MULCHING**

#### **III.1. SEED**

The grass seed shall be scattered uniformly at a rate of 60 pounds per acre. During the period March 15 to October 15, the seed mixture shall be 30 pounds of Argentine Bahia and 30 pounds of hulled Bermuda. During the remainder of the year the mixture shall be 20 pounds each of Bahia, Bermuda and Rye grass seed. All grass seed shall be mixed with soil prior to sowing in a manner insuring an even distribution and retainage of the seed on the site. The seed shall then be lightly raked into the ground.

#### **III.2. MULCH**

The mulch material shall be straw or hay, consisting of oats, rye or wheat straw, or a Pangola, Peanut, Bermuda or Bahia grass hay. Immediately after completion of seeding, dry mulching shall be uniformly applied over the seeded area. The mulch shall be spread at a rate of 9 tons per acre and cut into the soil or anchored in a satisfactory manner. Mulch shall be free from undesirable weed and other undesirable grasses.

### **IV. SPRIGGING**

Where specified, after placing the top soil, the entire area shall be grassed by planting sprigs. St. Augustine grass or other types, as directed by the Engineer, shall be cut into stolons approximately 4 inches long and planted endwise in furrows 2 inches deep. The furrows shall be 8 inches apart and stolons planted 6 inches apart in the furrows. Other methods of planting sprigs that will provide an equal stand of grass may be approved.

### **V. SODDING**

When called for in the plans and special conditions, grass sod shall be furnished and placed in the areas to be grassed and shall be maintained to assure a healthy strand of grass.

#### **V.1. MATERIAL**

Sod shall be St. Augustine, Centipede or Bahia to match existing grass type. The sod shall be live, fresh and uninjured at the time of planting. Sod shall be free of weeds and other grasses. Sod with mesh backing shall not be allowed in residential locations or any areas common to foot traffic such as sports fields, parks, etc.



# *JEA Water and Wastewater Standards*

## *441 Grassing*

### **V.2. PLACEMENT**

- V.2.1. Sodding shall be incorporated into the project at the earliest practical time in the life of the contract. No sod which has been cut for more than 72 hours shall be used unless specifically authorized by the Engineer after his careful inspection thereof. Any sod which is not planted within 24 hours after cutting shall be stacked in an approved manner and maintained properly moistened.
- V.2.2. Sodding shall not be performed when weather and soil conditions are, in the Engineer's opinion, unsuitable for proper results. The sod shall be placed on the prepared soil surface and shall be clear of trash, debris, roots, branches, stones and clods in excess of 1 inch in diameter, or 2 inches in length. Sod shall not be applied to gravel or other non-soil surfaces. Any irregularities in the soil surface shall be filled or leveled in order to prevent the formation of depressions. Place sod in straight (not curved) parallel rows with edges butting to form a solid mass with tightly fitted joints, without stretching or overlapping. Lateral joints shall be staggered to promote more uniform growth and strength. Entire sodded area shall be firmly and smoothly embedded by light tamping with appropriate tools or rolled with a 200-lb roller. The finished elevation of the sod shall be smooth and even with the adjacent existing areas. The sub-grade shall be moist but not wet when sod is laid.
- V.2.3. If gaps in the new sod are found during inspection, the Contractor may be allowed to fill in the gaps with proper growing soil from clean/select backfill only if authorized by the Engineer; otherwise, the sod placement in question shall be removed and reinstalled after finish grading correction.
- V.2.4. The sod shall not be placed on top of existing grade as to create high points. All disturbed areas shall be stripped of any grassing, grade lowered as required to allow the new sod elevation to match the pre-existing finish grade, and placed on the prepared soil surface.
- V.2.5. Where sodding is used in drainage ditches, the setting of the pieces shall be staggered, laying sod across the direction of flow such as to avoid a continuous seam along the line of flow. In order to prevent erosion caused by vertical edges at the outer limits, the outer pieces shall be tamped so as to produce a featheredge effect. In critical areas including water-carrying channels, secure sod with chicken wire, jute or other netting by pegging or stapling flush over the sod for extra protection during the establishment period. Netting installation shall be parallel to the direction of flow. Upslope ends of net shall be buried in a slot or trench no less than 6 inches deep.
- V.2.6. On slopes 3:1 and greater, or wherever erosion may be problematic, the sod shall be laid with staggered joints and secured with pegging or other approved methods. Sod shall be installed with the length perpendicular to the slope, beginning at the bottom of the slope and working uphill. Any pieces of sod which, after placing, shows an appearance of extreme dryness shall be removed from the work.
- V.2.7. Any pieces of sod which, after placing, shows an appearance of extreme dryness shall be removed and replaced.
- V.2.8. Within two (2) hours after installing sod and before rolling, the sod shall be lightly irrigated. Immediately after rolling, the sodded area shall be thoroughly watered to sufficiently moisten the soil to a depth of four (4) inches.

### **VI. FERTILIZING**

# *JEA Water and Wastewater Standards*

## *441 Grassing*

Immediately before seeding, sodding or sprigging, fertilizer shall be applied at a rate of 600 pounds per acre and scarified into the surface to a depth of approximately 1 inch. Fertilizer shall be 8-8-8, organic analysis as follows:

- Total Nitrogen: Not Less Than 8.00%
- Available Phosphoric Acid: Not Less Than 8.00%
- Water Soluble Potash: Not Less Than 8.00%

### **VII. HYDRO SEEDING:**

All seed shall meet the requirements of the State Department of Agriculture and Consumer Services and all applicable state and local laws. The Contractor shall submit to the Engineer a certification tag for each type of seed used prior to sowing of seed. The certification tag shall have the following information:

- Grass Type and Variety
- Percent of Inert Matter
- Germination Percentage
- Percent of Weed Seed

#### **VII.1. PREPARATION OF GROUND**

Final grading and cleaning shall be completed prior to the preparation of ground for grassing. The areas to be grassed shall be scarified or-loosened to a depth of at least six (6) inches. All areas shall be smooth and free of large clods, roots and other materials which may interfere with the work or future mowing and maintenance operation. No subsequent operations shall be commenced until the Engineer has approved the condition of prepared areas.

#### **VII.2. APPLICATION AND RATES**

The grass seed shall be applied at a rate of 60 pounds per acre in combination with cellulose fiber mulch at a rate of 750 pounds per acre. During the period March 15 to October 15, the seed mixture shall be 30 pounds of Argentine Bahia and 30 pounds of hulled Bermuda. During the remainder of the year the mixture shall be 20 pounds each of Bahia, Bermuda and Rye grass seed.

Apply the hydro seeding in the form of a slurry consisting of commercial fertilizer, hydro mulch and seed. When hydraulically sprayed onto the soil, the mulch shall form a blotter- like material. Contractor shall save all seed and fertilizer tags and fiber mulch bags for the Engineer to verify compliance with the drawings and specifications. Do not let the hydro slurry components rest in the hydro seeding machine for more than two (2) hours because of possible seed destruction. All mixtures more than eight (8) hours old must be disposed, off-site, at the contractor's expense. Slurry applied onto hardscapes including concrete walks, fences, walls, buildings, etc. shall be removed at the contractor's expense.

### **VIII. NON GRASSED AREAS**

Grassing will not be required along pipeline locations falling within areas not covered by a stand of grass or other suitable growth at the time of construction. Such areas shall be established and agreed upon by the Engineer prior to excavation.

### **IX. SOIL MOISTURE**

Seed, sod and sprigs shall be placed only when the soil is moist and in proper condition to induce growth.

### **X. MAINTENANCE**

# *JEA Water and Wastewater Standards*

## *441 Grassing*

The Contractor shall be responsible to see that all planted areas, including seeded, sprigged and solid sodded areas, receive sufficient water and maintenance during the life of this contract or until a satisfactory growth of grass is established acceptable to the Engineer. Maintenance shall include the filling, leveling and repairing of any washed or eroded areas, as may be necessary.

## 490 - PAVING

### I. GENERAL

The work under this section includes the furnishing and installation of paving for the entire project as set forth on the plans and as outlined herein.

### II. REFERENCE

All paving work within City of Jacksonville right-of-way shall conform to the applicable City of Jacksonville Standard Specifications and Details for Paving and Striping. All paving work within the Florida Department of Transportation right-of-way shall conform to the applicable Florida Department of Transportation Specifications for Paving. Paving outside of D.O.T. or City of Jacksonville right-of-way shall be as specified by the Engineer.

*Blank Page*

## **491 - SIDEWALK, DRIVEWAY, CURB AND GUTTER**

### **I. GENERAL**

The work under this section includes the furnishing and installation of sidewalk, driveway, curb and gutter for the entire project as set forth on the plans and as outlined herein.

### **II. REFERENCE**

All sidewalk, driveway, curb and gutter work within City of Jacksonville right-of-way shall conform to the applicable City of Jacksonville Standard Specifications and Details for sidewalk, driveway, curb and gutter. All sidewalk, driveway, curb and gutter work within the Florida Department of Transportation right-of-way shall conform to the applicable Florida Department of Transportation Specifications for sidewalk, driveway, curb and gutter. All sidewalk, driveway, curb and gutter work, not in the City of Jacksonville or Florida Department of Transportation right-of-way, shall conform to City of Jacksonville standards, unless specified otherwise. Handicapped ramps shall be constructed in accordance with Chapter 11 of the Florida Accessibility Code and American with Disabilities Act Accessibility Guidelines (ADAAG). All new sidewalks installed shall include handicap ramps. Handicap ramps shall not be installed if sidewalk is not being disturbed.

*Blank Page*

## 492 - FENCING

### I. SCOPE OF WORK

The work under this section includes furnishing all labor, material, equipment, and the erection of chain link fencing complete with all appurtenances as indicated in the Contract Documents or as specified herein. All references to ASTM Specifications shall mean the latest edition published prior to Contract Bid Date. Unless noted otherwise on the contract documents, the fencing shall be 6 feet high (MIN), one inch off ground and meet the specifications as noted below.

### II. MATERIALS

#### II.1. BASE METAL

Unless specified otherwise, the fabric for fencing shall be No. 9 gauge galvanized steel wire 2-inch mesh (1, 290 lb breaking load wire) with black (PVC) vinyl coating. All other appurtenances (post, gate and other) shall be galvanized with black vinyl coating.

#### II.2. ZINC COATING

Zinc coating shall be Class I, hot dipped galvanized with a coating of 1.2 ounces per square foot of fabric, per ATSM A392. The weight of zinc coating on the fabric shall be determined in accordance with the method described in ASTM Designation A90.

#### II.3. VINYL COATED FABRIC

Class 2, bonded PVC-coated wire shall have the PVC coating thermally fused and bonded to a primer which is thermally cured onto galvanized steel core wire. Galvanized steel core wire shall have been coated with zinc as per ASTM A641 (9 gauge – 0.30 oz. per square foot of fabric).

#### II.4. VINYL PRIVACY SLATS

Slats shall be black vinyl or PVC material and provide an 85% capacity (min).

#### II.5. VINYL COATED POSTS AND RAILS

Polymer coated framework shall have a PVC coating fused and adhered to the exterior zinc coating of the post or rail. PVC coatings shall have a minimum thickness of 10-mils (0.254 mm) per ASTM F1043. Color to match the fabric.

#### II.6. VINYL COATED TENSION WIRE

Polymer coated steel tension wire: 7 gauge wire complying with ASTM F1664. Class 2b, fused and adhered. Color to match the fabric.

#### II.7. VINYL COATED FITTINGS

In compliance with ASTM F626, polymer coating minimum thickness 0.006 in. (0.152 mm) fused and adhered to zinc coated fittings. Color to match the fabric.

### III. SELVAGE

Fabric 72 inches high (MIN) shall be furnished with knuckling on top selvage and twisting on the bottom end.



# JEA Water and Wastewater Standards

## 492 Fencing

### IV. FABRIC CONNECTIONS

The chain link fabric shall be securely fastened to all terminal posts using 3/16 inch by 3/4 inch tension bars. Posts with a 2-1/2 inch O.D. and under shall use 14 gauge tension bands and posts from 2-1/2 inches to 8 inches shall use 12 gauge tension bands. All connections shall have a finish applied which matches the fabric.

### V. POSTS

#### V.1. ZINC COATING

All steel and iron parts shall be zinc coated by the hot-dipped method, using zinc Grade "E". The weight of zinc coat on the rail, post and brace with black vinyl exterior coating shall have less than 1.8 ounces per square foot. Zinc weight shall be determined in accordance with ASTM A90.

#### V.2. REQUIREMENTS

All posts and rails shall meet the following minimum bending moment requirements:

FENCE INDUSTRY O.D.	MIN. BENDING MOMENT – IN. LBS.
1-5/8" (Top Rail)	8,225
2"	11,410
2-1/2" (Line post)	19,635
3" (Corner post)	37,100
3-1/2"	60,200
4"	83,650

#### V.3. INSTALLATION

V.3.1. Posts shall be spaced equidistant in the fence line on a maximum of ten (10) foot centers. The distance between pull posts shall not exceed 500 feet. Posts shall be plumb with the tops of the posts and properly aligned. Pull posts shall be installed at breaks in vertical grades of fifteen (15%) percent or more. The maximum interval may be reduced by the Engineer where the degree of break is greater than three (3) degrees. Corner posts are to be installed at all horizontal breaks in fence of fifteen (15) degrees or more. Gate posts shall be spaced as required for walk and roadway openings. All posts shall be set in concrete. Post holes shall be bell shaped.

V.3.2. Line posts shall be thirty (30) inches deep below finished grade, with a minimum diameter of nine (9) inches at the top. Terminal, corner and gate post holes shall be thirty-six (36) inches deep below finished grade with a minimum diameter of twelve (12) inches at the top. All posts shall be set twenty-four (24) (MIN) inches in the hole with four (4) inches of concrete below the end of the post. The top exposed surface of the concrete footing shall be sloped to shed water and provide a neat appearance when completed. Barbed wire supporting arms (when specified) shall be firmly seated on the top of the posts, set outside at a 45 degree angle up and perpendicular to the fence line.

#### V.4. TOP RAILS

Top rails shall be fitted with couplings or wedged for connecting the lengths into a continuous run. The couplings shall be not less than six (6) inches long, with .070 minimum wall thickness, and shall allow for expansion and contraction of the rail. Open seam outside sleeves shall be permitted only with a minimum wall thickness of .100 inches. Suitable ties or clips shall be provided in sufficient number for attaching the

# *JEA Water and Wastewater Standards*

## *492 Fencing*

fabric securely to the top rail at intervals not exceeding two (2) feet. Means shall be provided for attaching the top rail to each gate, corner, pull and end post. All fencing shall have a 1-5/8 inch O.D. top rail, unless specified otherwise.

### **V.5. POST BRACES**

Post Braces shall be provided for each gate, corner, pull, and end post and shall consist of a 1-5/8" O.D. round tubular brace extending to each adjacent line post at approximately mid-height of the fabric, and a truss consisting of a rod not less than 5/16" nominal diameter from the line post back to the gate, corner, pull or end post, with a turnbuckle or other equivalent provision for adjustment. Truss rods may be eliminated in any line of fence where there is a continuous center rail. The braces and truss rods shall have the same finish as the posts.

### **V.6. POST TOPS**

Post tops shall consist of ornamental tops. The top shall be provided with a hole suitable for the through passage of the top rail. The post tops shall fit over the outside of posts and shall exclude moisture from posts.

## **VI. GATES**

Gates shall be swing or sliding as specified, complete with latches, stops, keepers and hinges.

### **VI.1. GATE FRAMES**

Gate frames shall be constructed of tubular members welded at all corners or assembled with fittings. On steel, welds shall be painted with zinc-based paint. Where corner fittings are used, gates shall have truss rods of 5/16" minimum nominal diameter to prevent sag or twist. Gate leaves shall have vertical intermediate bracing as required, spaced so that no members are more than eight (8) feet apart. Gate leaves ten (10) feet or over shall have a horizontal brace or one 5/16" minimum diagonal truss rod.

### **VI.2. GATE FABRIC**

Gate fabric shall be of the same type used in the fence construction. The fabric shall be attached securely to the gate frame at intervals not exceeding 15 inches.

### **VI.3. GATE HINGES**

Gate hinges shall be of adequate strength for gate, and with large bearing surfaces for clamping in position. The hinges shall not twist or turn under the action of the gate. The gates shall be capable of being opened and closed easily by one person.

### **VI.4. GATE LATCHES**

Gate latches, stops and keepers shall be provided for all gates. Latches shall have a plunger-bar arranged to engage the center stop, except that for single gates of openings less than ten (10) feet wide, a forked latch may be provided. Latches shall be arranged for locking. Center stops shall consist of a device arranged to be set in concrete and to engage a plunger bar of the latch of double gates. No stop is required for single gates. Keepers shall consist of a mechanical device for securing the free end of the gate when in the full open position.

### **VI.5. GATE POSTS**

Posts for swing gates shall be pipe of the following nominal sizes for each gate leaf:

# *JEA Water and Wastewater Standards*

## *492 Fencing*

GATE LEAF SIZE	MIN POST SIZE	MIN BRACING REQUIRED
Gate Leaf up to 6 ft. Wide	3" O.D.	(None)
Gate Leaf over 6 ft. to 13 ft. wide	4" O.D.	1 Cross Brace and 1 Truss Rod
Gate Leaf >13 ft. to 18 ft. wide	6-5/8" O.D.	Vertical Bracing at 1/3 points & 3 Truss Rods

### **VII. TENSION WIRE**

Tension wire shall be marcelled (spiraled or crimped) #7 gauge (.177 in.) plus or minus 0.005 inches in diameter. Zinc Coated tension wire shall be Class III (0.80 oz. of zinc per square foot of uncoated wire surface). Aluminum tension wire shall have 0.40 oz. of aluminum per square foot of wire surface. Tension wire shall have the same surface as the fabric.

### **VIII. SECURITY FENCE UPDATE**

Contact [securityservice@jea.com](mailto:securityservice@jea.com) for latest security fence update.

## **493 - DRAINAGE**

### **I. GENERAL**

The work under this section includes the furnishing and installation of drainage improvements for the entire project as set forth on the plans and as outlined herein.

### **II. REFERENCE**

All drainage work within the City of Jacksonville right-of-way shall conform to the applicable City of Jacksonville Standard Specifications and Details for Drainage. All drainage work within the Florida Department of Transportation right-of-way shall conform to the applicable Florida Department of Transportation Specifications for Drainage

*Blank Page*

## **SECTION II – GENERAL SPECIFICATIONS – SPECIFICS**

- 439 - General Equipment Requirements
- 447 - Water Wastewater Protective Coatings
- 472 - Emergency Generator (< Than 600kw)
- 494 - Instrumentation and Controls Integrator Requirements
- 495 - Variable Frequency Drive Specifications
- 501 - As-Built Drawings
- 801 - Measurement and Payment

*Blank Page*

## **439 - GENERAL EQUIPMENT REQUIREMENTS**

### **I. SCOPE**

The scope of this section is to provide, install and render ready for use, any and all equipment required by the Contract Documents. The Contractor shall consult the appropriate section(s) of the specifications for specific equipment.

### **II. EQUIPMENT**

All items and equipment shall be new and of the highest quality. The supplier and manufacturer, in addition to the Contractor, shall assume responsibility for the proper functioning of the equipment furnished.

#### **II.1. NAMEPLATE**

Each piece of equipment shall be provided with a substantial nameplate of non-corrodible metal, securely fastened in place, and clearly and permanently inscribed with the manufacturer's name, model or type designation, serial number, rated capacity, electrical or other power characteristics and other appropriate nameplate data.

#### **II.2. ANCHORAGE**

All anchor bolts, nuts and washers shall be of type 316 stainless steel unless otherwise specified and shall be furnished by the equipment manufacturer where applicable. The anchor bolts shall be placed by the Contractor in accordance with certified prints furnished by the equipment manufacturer.

#### **II.3. LUBRICATION**

When possible, equipment shall be fully serviced prior to delivery. All exceptions shall be clearly marked to the effect that servicing is required before operation.

#### **II.4. OPERATION MANUALS AND PARTS LIST**

The Contractor shall furnish 6 complete, bound sets of literature on the equipment furnished giving clear and concise instructions for operation, adjustment, and lubrication and other maintenance of the equipment. These instructions will include a complete lubrication chart. See section 445 for detailed requirements.



*Blank Page*

## **447 - WATER WASTEWATER PROTECTIVE COATINGS**

### **I. GENERAL REQUIREMENTS**

#### **I.1. APPROVED MANUFACTURER AND INSTALLATION CONTRACTOR**

A JEA approved coating manufacturer shall include an accompanying contractor of the manufacturer's choice for specialty coatings on interior/exterior structures.

#### **I.2. SCOPE OF WORK**

A JEA approved Coating Manufacturer shall be permitted to place one bid per project. The coating manufacturer shall provide coating specifications for the project as the manufacturer deems appropriate. The coating manufacturer/contractor shall furnish, install, and test the structures' coatings as specified herein. All references to Industry Standards (ASTM, ANSI, AWWA, NACE etc.) shall be to the latest revision unless otherwise stated. Only those materials included in the JEA Water and Wastewater Standards Manual shall be installed.

#### **I.3. WORK PLAN**

Prior to beginning work, the coating manufacturer/contractor must submit to the JEA Representative a work plan detailing the coating materials, the procedure and schedule to be used to execute the project. The coating project shall not commence until the coating manufacturer/contractor has received written approval of all work plan submittals from JEA.

#### **I.4. WORKMANSHIP**

All work shall be proved to be in first class condition and application in accordance with the submitted and approved specifications. All defects disclosed by tests and inspections shall be remedied immediately by the coating manufacturer at no expense to JEA.

#### **I.5. PROJECT SCHEDULE AND COOPERATION**

The project schedule shall be established on the basis of working a normal work schedule including five days per week, single shift, eight hours per day or four days per week, single shift, ten hours per day. Unless approved otherwise by JEA, normal or general items testing and final inspections shall be scheduled during the normal work schedule. Due to operational and manpower limitations on the JEA systems, JEA will may require the contractor to perform work outside of the normal work schedule. These operational and manpower limitations, including but not limited to, other phases of the work which may impact the continued (non-interruptible) service to existing JEA customers. The coating manufacturer/contractor shall plan and anticipate the cost impact of these system limitations and provide such work or services at no additional cost to JEA.

#### **I.6. PERMITS**

The Contractor shall verify the existence of all permits before commencing any work on the project.

#### **I.7. WARRANTY**

The coating manufacturer shall warrant the coating against defects for at least two (2) years after the date of acceptance by JEA. Defects are defined as cracking, delamination or excessive fading. The warranty shall require the coating manufacturer to supply all necessary labor, materials, and equipment to repair defects to the satisfaction of JEA. The coating manufacturer shall not make any exemption or exception to

# *JEA Water and Wastewater Standards*

## *447 Water Wastewater Protective Coatings*

the above stated conditions or warranty. Non-compliance of the warranty by the coating manufacturer shall result in removal from JEA Water and Wastewater Standards approved materials list for no less than 24 months.

### **I.8. CAPITAL PROJECTS**

Capital improvements work will require that the Engineer of Record originate an industrial coating specification that includes but is not limited to a 5-year warranty period.

## 472 - EMERGENCY GENERATOR (LESS THAN 600 KW)

Shared Services Generator Specifications

Refer to [https://www.jea.com/Engineering\\_and\\_Construction/jea\\_facilities\\_standards](https://www.jea.com/Engineering_and_Construction/jea_facilities_standards)

Contact information for the Project Administrator:

Grover, Nicolas E.

grovne@jea.com

Office: 904-665-7526

*Blank Page*

## **494 - INSTRUMENTATION AND CONTROLS INTEGRATOR REQUIREMENTS**

### **I. GENERAL**

Instrumentation and control integrator companies and programmers doing work for JEA must adhere the following certification and experience requirements. Copies of current, valid certifications must be provided to JEA to maintain status as an approved JEA Instrumentation and Controls Integrator.

### **II. INTEGRATOR QUALIFICATION**

Based on a company's certifications and the experience level of its integrators/programmers it will be placed into one of two tiers that will determine the company's qualification to bid on projects of different levels of complexity.

#### **II.1. COMPANY CERTIFICATION**

- II.1.1. First tier approval is for major complex jobs and would consist of the integration company being a SCSP (Siemens Certified Solutions Partner) and the additional integrator experience required for complex jobs. See section III.3.1 for what defines complex jobs.
- II.1.2. Second tier approval is for simpler, less complex, jobs which would not require SCSP certification and the additional integrator experience required for simple jobs. See section III.3.2 for what defines simple jobs.
- II.1.3. All approved companies must have a permanent local office with actual street address. The local office location shall be within a four hour driving radius from Jacksonville, FL / Duval County.
- II.1.4. All approved companies shall require a minimum of two local certified integrators on staff capable of doing the work assigned. See section above for required certifications. Local is defined as an office location within a four hour driving radius from Jacksonville.

#### **II.2. INTEGRATOR CERTIFICATION AND EXPERIENCE**

- II.2.1. The actual integrators doing the work must be Siemens certified in Step 7, TIA Portal, and/or WinCC as required by the programming required by the project.
- II.2.2. Refer to the Integrator Experience Matrix in III.4 to evaluate the combination of Siemens programming and water wastewater programming experience for each programmer to determine qualification for working on complex and/or simple projects.

### **III. PROJECT QUALIFICATION**

#### **III.1. COMPANY PROJECT QUALIFICATION**

- III.1.1. Tier one approved companies may do work on complex, simple or incidental projects provided the integrator assigned to do the work meets the experience requirements in the Integrator Experience Matrix.

# ***JEA Water and Wastewater Standards***

## ***494 Instrumentation and Controls Integrator Requirements***

III.1.2. Tier two approved companies may not do complex projects. Tier two approved companies may do simple and incidental projects provided the integrator assigned to do the work meets the experience requirements in the Integrator Experience Matrix.

### **III.2. INTEGRATOR PROJECT QUALIFICATION**

#### **III.2.1. COMPLEX PROJECT INTEGRATOR EXPERIENCE REQUIREMENT**

The integrator assigned to do the work must have a combination of Siemens programming and water wastewater programming experience to qualify for a complex project (Green area of matrix).

#### **III.2.2. SIMPLE PROJECT INTEGRATOR EXPERIENCE REQUIREMENT**

The integrator assigned to do the work must have a combination of Siemens programming and water wastewater programming experience to qualify for a simple project (Yellow or Green area of matrix).

#### **III.2.3. INCIDENTAL PROGRAMMING INTEGRATOR EXPERIENCE REQUIREMENT**

The integrator assigned to do the work must have a combination of Siemens programming and water wastewater programming experience to qualify to work on incidental programming tasks. (Red, Yellow or Green area of matrix)

### **III.3. PROJECT COMPLEXITY DEFINITIONS**

#### **III.3.1. COMPLEX PROJECT**

A complex project is any water, wastewater, or reuse process control system project that contains any one of the following:

- Two or more PLCs that communicate with each other.
- Two or more PI or PID loops, with a cascading loop counting as two.
- Plant HMI development (not local Operator displays)
- Potable Water Treatment
- Other features as specified in the project scope (e.g. processes/technologies that are new to JEA)

#### **III.3.2. SIMPLE PROJECT**

A simple project is any water, wastewater, or reuse process control system project that is not classified as a complex project.

#### **III.3.3. INCIDENTAL PROGRAMMING**

Incidental programming work, includes but is not limited to, development of Function Blocks (FB) or Function Calls (FC) for use in operating logic, development of an API or ActiveX controls for an HMI, or conversion of existing logic from Step7 to TIA Portal under the direct supervision of JEA Management.

# JEA Water and Wastewater Standards

## 494 Instrumentation and Controls Integrator Requirements

### III.4. INTEGRATOR EXPERIENCE MATRIX

Years of Siemens Programming	10	R	Y	G	G	G	G	G	G	G	G	G
	9	R	Y	G	G	G	G	G	G	G	G	G
	8	R	Y	G	G	G	G	G	G	G	G	G
	7	R	Y	Y	G	G	G	G	G	G	G	G
	6	R	Y	Y	Y	G	G	G	G	G	G	G
	5	R	Y	Y	Y	G	G	G	G	G	G	G
	4	R	Y	Y	Y	Y	G	G	G	G	G	G
	3	R	R	Y	Y	Y	Y	G	G	G	G	G
	2	R	R	R	Y	Y	Y	Y	Y	Y	Y	Y
	1	R	R	R	R	R	R	R	R	R	R	R
	0											
	0	1	2	3	4	5	6	7	8	9	10	
Water/Wastewater Programming Experience												

G (green) = Qualified to work on complex projects  
 Y (yellow) = Qualified to work on simple projects  
 R (red) = Qualified to work on incidental support projects



*Blank Page*

## **495 - VARIABLE FREQUENCY DRIVES**

### **I. GENERAL**

These variable frequency drive specifications supersede all other JEA water wastewater variable frequency drive specifications that may be referenced elsewhere. All VFD's shall be on the JEA water wastewater approved manufacturer list. A VFD 100HP and above shall not be installed in an MCC without prior JEA Standards approval. If a VFD less than 100HP is installed in an MCC, the bucket must be upsized to the next largest frame of VFD to ensure future replacement.

#### **I.1. VFD RATED CABLE**

VFD Rated cable shall be installed on the output of the drive for all VFD applications. Cable shall be high flexible stranded Class K circuit conductors or better with XLPE 0.03 in minimum insulation, tinned copper strands, foil shield and braid. For 1 AWG and above cable must have three symmetrically positioned ground conductors for common mode rejection. For 1 AWG and above 2 mil dual foil shield shall be allowed. The cable shall be rated for a minimum of 1000V but may require higher based on design requirements. The cable shall be ran intact and as close to the VFD and motor terminals as possible for maximum shielding protection. Both ends of cable shall be installed with shielded gland plates that are rated for a corrosive environment for proper grounding and dielectric grease applied to prevent corrosion of cable. Follow all manufacturers' installation procedures and recommendations. The cable shall be Lutze DRIVEFLEX , SAB VFD Symmetrical XLPE TR or Belden Extra Flexible series.

#### **I.2. LINE REACTORS**

VFD's shall have a minimum 5% AC Line Reactor or equivalent for harmonic mitigation either as an internal feature or an external device such as a line reactor or DC choke for below 75HP. For 75HP and above, the VFD must limit harmonic voltage and current to acceptable levels as defined by IEEE 519-2014 without the use of additional 12 or 18 Pulse Rectifier bridges. If harmonic mitigation is required, each VFD must have its own built in active filter or passive filter provided for each VFD such as a Matrix or TCI filter. If a passive filter is used, a contactor shall be provided to prevent leading power factor. Standalone active filters will not be accepted unless pre-approved by JEA engineering and manager of facility for large applications or medium voltage.

#### **I.3. OUTPUT FILTER**

dV/dT Output filter is required if the motor to the drives rated distance is exceeded based on the drive manufacturers specifications or design requirements. Cable type, conduit type, motor insulation rating and cable length shall be used to calculate the maximum distance in order to protect the motor from voltage spikes and overheating.

#### **I.4. VFD PROGRAMMING**

All VFD's shall come pre-programmed to the description of the specified application.

#### **I.5. VFD DRAWINGS**

All drawings shall come with a parameter sheet, on the drawing, with instructions for drive parameter configuration of the application.

#### **I.6. FRONT END SURGE SUPPRESSION**

# *JEA Water and Wastewater Standards*

## *495 Variable Frequency Drives*

Provide front-end surge suppression (internal or external) to protect input electronics. The protection shall at minimum meet (VDE 0160 Standard—2.3 x line voltage for 1.3 msec) for transient protection.

### **II. VFD SPECIFIC REQUIREMENTS**

#### **II.1. SIZING**

VFD's shall be sized for 110% continuous and 120% for 1 minute.

#### **II.2. RATING**

II.2.1. VFD's shall be rated for a minimum of 50 Celsius ambient temperature at full load capacity without shortening the lifespan. If the VFD is not able to meet this requirement then it shall be upsized till it meets it.

II.2.2. In applications with the VFD heatsink out the back design, for venting the heat to the outside, drives shall be rated a minimum of NEMA 12.

II.2.3. Rated for service in a corrosive environment. Provide documentation that the drive as a whole and not just individual components/assemblies meets at minimum IEC/EN 60721-3-3 3C3 or ANSI/ISA-71.04 G3 ratings.

#### **II.3. REQUIRED CERTIFICATION**

Certification through Profi International (PI) for compliances with the Profibus DP and Profinet protocols and the Profidrive interface on all telegrams to ensure it matches published standards for communication with automation controllers (ie PLCs). PPO4 and PPO5 telegrams shall be available and conform to IEC 61800-7 and Profidrive telegrams. Shall be able to transmit Actual Power, % Torque, Motor Current, Alarm Code and Fault Code over PPO telegrams.

#### **II.4. ADDITIONAL REQUIREMENTS**

II.4.1. Each drive shall come with a keypad that supports Local/Remote, Jog, Run and Stop. Shall have ability to reverse the pump through keypad.

II.4.2. VFD's shall be flange mount capable and capable of a free standing design.

II.4.3. Capability to detect a dead short on the output and prevent damage to the VFD. Drive shall also be able to be disconnected while the motor is running, with no status indicator to the drive, and be able to protect itself.

II.4.4. The drive manufacturer shall supply the drive and all necessary options as specified. VFDs that are manufactured by a third party and "brand labeled" shall not be acceptable.

II.4.5. Front panel mounted potentiometers are permitted and must be rated as corrosion resistant.

### **III. WARRANTY**

All drives shall come with a certified five year warranty with documentation showing proof. JEA is not responsible for any warranty costs including travel, labor, parts, or other costs for a full 5 years from the date of startup of the Drive. The warranty shall cover all drive failures including line anomalies – including lightning strikes, load

## *JEA Water and Wastewater Standards*

### *495 Variable Frequency Drives*

anomalies, moisture or corrosives. During the warranty period, the VFD distributor shall repair or replace the warranted VFD at no cost to JEA.

#### **III.1. COMMISSIONING**

Startup of the drive shall be commissioned by a certified factory representative.

#### **III.2. SERVICE TECHNICIANS**

The VFD distributor shall employ and make available proficient manufacturer-authorized service technicians to perform service calls to VFDs supplied to JEA within 48 Hours. The VFD distributor shall provide service technicians, all necessary tools, test and safety equipment, etc., that are required to make field repairs. Service personnel shall adhere to all JEA Safety Rules & Regulations.

*Blank Page*

## 501 - AS-BUILT DRAWINGS

### I. GENERAL REQUIREMENTS

#### I.1. REQUIREMENTS

As-Built or record drawings are required for all JEA owned potable water, wastewater, chilled water and reclaimed water pipelines, pump stations, treatment plants and facilities located in either public right-of-way, in a dedicated JEA easement or on JEA property and shall be prepared in conformance with Section 501. All private (excluding single family residential) water, wastewater and reclaimed water pipelines and facilities are required to be as-built; however, the as-builts of the private facilities do not have to meet the same requirements outlined in Section 501. The following definitions shall apply to this section:

#### I.2. DEFINITIONS

##### I.2.1. AS-BUILT(S)

- I.2.1.1. Applies to Work involving new construction or replacement construction and/or requires a Permit for Construction.
- I.2.1.2. They are a revised set of drawings that represent and document the final materials and location of installed Work. They reflect all changes made by Addendum, change order, or Supplemental Work Allowance (SWA) during the construction process, and show the exact dimensions, geometry, and location of all elements of the Work completed by a Contractor under a contract.
- I.2.1.3. They are submitted by the Contractor and certified by a Professional Land Surveyor in the employ of the Contractor or by a Professional Engineer in the employ of the Contractor upon completion of a project or of a phase of a project.

##### I.2.2. RECORD DRAWING(S)

- I.2.2.1. Applies to Work involving maintenance and/or minor replacement of existing infrastructure which does not require any Permit for Construction.
- I.2.2.2. They are a revised set of drawings that represent and document the final materials and location of installed Work. They show the exact dimensions, geometry, and location of all elements of the Work.
- I.2.2.3. These drawings do not require certification by a Professional Land Surveyor or Professional Engineer.

##### I.2.3. REDLINE DRAWING(S)

- I.2.3.1. Applies to Work that is ongoing and documents the current installation progress of planned Work or applies to field observations and/or findings that represent a deviation, discovery, or change from expected conditions.

# *JEA Water and Wastewater Standards*

## *501 As Built Drawings*

I.2.3.2. These drawings do not require the certification by a Professional Land Surveyor or Professional Engineer.

I.2.3.3. They represent and document the current materials and location of installed work.

### **I.3. SUBMITTAL TIMING**

Upon completion of the Work and prior to dedication of utilities to JEA or final payment under the Contract with JEA, Contractor shall furnish to JEA electronic copies of asset data tables and as-built drawings or record drawings and certified paper copies of the as-built or record drawings which have been revised to indicate final as-built data (true to scale) and in accordance with all addenda, change orders, verbal field changes, JEA directives, Supplemental Work Account (SWA)s, and all requirements with respect to the drawings specified herein. A JEA representative shall verify as-built information is consistent with observable field conditions. Redrawn as-builts will be deemed unacceptable.

### **I.4. JEA PROJECT WORK**

I.4.1. An electronic file of the original Project drawings will be furnished to Contractor for the purpose of recording and preparing as-built or record drawings.

I.4.2. The Contractor shall provide access to buried facilities to allow for accurate horizontal and vertical measurements to be acquired by the surveyor or engineer as needed. Should discrepancies exist, at the discretion of JEA, and at no cost to JEA, the contractor shall verify buried facilities.

I.4.3. All as-built information shall be recorded and kept current during the progress of the Work. Monthly, the Contractor or Developer's authorized agent shall furnish to the JEA Representative a copy "redline" set of drawings identifying those field changes made to the Work to date, along with a copy of the associated field notes. Revisions and recording of information on the "redline" copy set of drawings shall be done to scale, in red ink, clearly and accurately identifying those changes to the Work. The JEA Representative may review and comment on the drawings which shall be incorporated into the next month's as-built submittal. Failure to incorporate changes in the following month submittal may result in rejection of any invoice submittal to JEA, denial of certification of completion or denial of acceptance by JEA.

I.4.4. The JEA representative will review and comment on the proposed final as-built drawings. The subsequent submittal shall incorporate a copy set of CADD drawing preliminary as-builts with comments by JEA. The JEA Representative shall review and comment on the copy set of CADD drawings which shall be incorporated into the final as-built submittal.

### **I.5. SIGNED DOCUMENTS**

#### **I.5.1. AS BUILT DRAWINGS**

Each page of the as-built drawings shall bear the printed name, and the signed as-built certification of the general contractor, and the signed and sealed as-built certification of the professional surveyor and mapper (PSM) or registered professional engineer (PE) who provided the horizontal and vertical dimensions and elevations on the as-built drawing. The signatures shall certify that the as-built drawings do, in fact, reflect the true as-built conditions as located under the direct supervision of the registered surveyor and/or professional engineer. The drawings shall be certified using the forms provided by JEA (See the end of this section).

# *JEA Water and Wastewater Standards*

## *501 As Built Drawings*

### **I.5.2. REDLINE DRAWINGS**

Each page of the reline drawings shall bear the printed name, and the signed redline certification of the project manager who provided the horizontal and vertical dimensions and elevations on the as-built drawing. The signature shall certify that the re-line drawings do, in fact, reflect the true built conditions of the infrastructure. The drawings shall be certified using the forms provided by JEA (See the end of this section).

### **I.6. FINAL SUBMITTALS**

Upon completion of the work, Contractor shall deliver the following completed documents:

#### **I.6.1. As-Built drawings required for all projects requiring permitting:**

I.6.1.1. As-built drawings in .dwg format (Auto CAD) including all xref files

I.6.1.2. As-built drawings in PDF format

I.6.1.3. As-built drawings in paper format with two copies certified and embossed on 24" x 36" paper

I.6.1.4. As-built submittal check lists, signed and completely filled out

I.6.1.5. As-built submittal transmittal form

I.6.1.6. Asset data tables for each asset type in JEA electronic format

#### **I.6.2. Record Drawings required for all minor maintenance work, water plants, wastewater plants, potable water wells, and reclaimed facilities that do not require permitting:**

I.6.2.1. Record drawings in .dwg format (Auto CAD) including all xref files

I.6.2.2. Record drawings in PDF format

I.6.2.3. Record drawings in paper format on 24" x 36" paper

I.6.2.4. Record drawing submittal check lists

I.6.2.5. Record drawing submittal transmittal form

I.6.2.6. Equipment attribute forms or Asset data tables for each asset type in JEA electronic format

#### **I.6.3. JEA will review the submittal for correctness and completeness and will return either an approval stamp or list of required changes for resubmission. Resubmittal of final drawings, with completed revisions, shall be accompanied by the marked-up set of revision requirements as provided by JEA.**

## **II. DRAWING REQUIREMENTS**

When making changes to the AutoCAD drawing for as-built purposes, originally designed utility lines that were installed differently in the field shall be deleted with the applicable notes and the correct location, notes and coordinates should be drawn in and/or added in to accurately portray the as-built conditions. Simply



# *JEA Water and Wastewater Standards*

## *501 As Built Drawings*

changing the coordinates, notes or just adding notes is not acceptable. Do not strike through notes or elevation call-outs, change them in the drawing to reflect as-built conditions. Lines, notations or required information not affected by addenda or SWAs shall not be disturbed. The legend used on the original Project drawings shall also be used to make all necessary corrections.

- II.1.1. Each document shall be labeled "AS-BUILT" or "RECORD DRAWING", as applicable, in approximately 1" high printed letters and shall be submitted on 24" X 36" sheets.
- II.1.2. Each document shall contain a graphic scale accurately representing the scale of the drawings.
- II.1.3. Each document shall contain a north arrow.
- II.1.4. As-builts shall utilize the State Plane Coordinate System using the Florida East Zone and the North American Datum of 1983 preferred for horizontal data; North American Vertical Datum (NAVD) 1988 Datum is preferred for elevation data. Benchmarks used must be shown and verified on the drawings.
- II.1.5. Deflections that result in a change of more than two feet from the designed alignment shall be located and recorded regardless of the presence of a fitting.
- II.1.6. To enable the efficient future location of the referenced facilities, the PSM or PE performing the as-built will independently verify the positional accuracy relative to the referenced horizontal and vertical datum. This will be accomplished through checks to published horizontal and vertical control points from local, state or federal agencies. These checks are to be independent of checks to local project control.
- II.1.7. The positional accuracy relative to the referenced published control points used shall not exceed 0.5' horizontally and 0.1' vertically. Elevations relative to the site facilities must be within 0.1' of each other.
- II.1.8. As-builts shall show physical dimensioning of the separation between water mains, sewer mains, reclaimed mains and chilled water mains at crossings with all water mains, wastewater mains and facilities, reclaimed mains, chilled water mains and storms drains and facilities. This can be shown by providing elevations of each pipe or structure, or noting measurement taken at the conflict crossing between the pipes or structures on the plan view. As-builts shall also show measurement of vertical and horizontal separation in areas where water mains are parallel to wastewater mains, reclaimed mains or storm drains. The vertical and horizontal separation shall be shown for the full length of the parallel run.
- II.1.9. Special detail drawings will be required where needed for clarity. Clarity is defined as pipe, fittings, valves, meter boxes, etc. clearly visible when printed to scale and when zoomed and viewed electronically.
- II.1.10. Vicinity map shall be included and be similar to a Google Map or Bing Map with an arrow pointing to the location of the project. Vicinity map shall not have aerial imaging. Vicinity map shall include major street names in bold allowing the project to be located quickly. Vicinity map on the cover sheet should be approximately 6 inches by 8 inches. Outside of the map write "Project Location" and a leader line pointing to the site.

# *JEA Water and Wastewater Standards*

## *501 As Built Drawings*

- II.1.11. Master Plan phase maps required for projects that are built in phases, the phase included in the as-built shall be shown as related to previous and future phases (as applicable). Phase maps shall be shown the cover page an on each document.
- II.1.12. Street names
- II.1.13. Match lines referencing the appropriate drawing page sheet number.
- II.1.14. All easements shall be shown with Official Record (OR) Deed book and page. Contractor shall coordinate with JEA real estate for JEA acquired easements.
- II.1.15. Unless approved otherwise by JEA, the minimum scale requirements on the drawings are as follows:
  - Pump Station Site: 1" = 5' (horizontal scale)
  - Plan & Profile: 1" = 40' (20' preferred, horizontal scale)  
1" = 4' (2' preferred, vertical scale)
  - Plan (only): 1" = 40' (20' preferred, horizontal scale)
- II.1.16. Separate drawings are required for water, wastewater, reclaimed and chilled water. No drawings will be accepted which contain a combination of the above construction types, unless otherwise approved by JEA Manager. Exceptions will be allowed for simple single service, small property improvements where all utilities can be clearly depicted on one sheet.
- II.1.17. All features depicted in the as-built drawings must be surveyed, JEA will spot check all coordinates to ensure accuracy.
- II.1.18. Failure to comply with the JEA Standards herein or failure to verify "As Builts" as required shall result in the Contractor, Engineer, and/or Surveyor being restricted from bidding on future JEA projects and being removed from the JEA approved engineer, surveyor or contractor's list for a minimum of twelve months.
- II.1.19. Cover sheet and each document sheet shall include the JEA Availability Number and/or the Oracle Work Order/Project Numbers for each commodity – Water, Wastewater, Reclaimed Water and Chilled Water. These numbers shall be approximately .3 inches tall and located under the "As-Built" notice. A JEA representative will provide the Work Order/Project Numbers at the preconstruction meeting and will be responsible for checking this information at the end of the project, when preliminary as-builts are submitted, to ensure that the Oracle Work Order/Project Numbers have not been modified/added throughout the project.
- II.1.20. A call out shall be provided identifying the points of connection of the new project to the existing JEA infrastructure.

### III. SPECIFIC SYSTEM REQUIREMENTS

#### III.1. PRESSURE PIPE SYSTEMS

This section covers pressure pipes including water, wastewater, reclaimed, vacuum and chilled.

# *JEA Water and Wastewater Standards*

## *501 As Built Drawings*

- III.1.1. The location of all piping, valves, fittings, fire hydrants, meter boxes, backflow preventers, manholes, vacuum pods, casings, private pump outs, and points of connection to the existing system shall be referenced by coordinates.
- III.1.2. The positional accuracy relative to the referenced published control points used shall not exceed 0.5' horizontally and 0.1' vertically. Elevations relative to the site facilities must be within 0.1' of each other.
- III.1.3. Coordinates and elevations on the main and finished grade will be required at all pipe dead ends, size changes, points of connection to existing system, fittings, valves, meter boxes, at intersections/crossings of pipes, and at 100' maximum intervals from the nearest pipe or fitting elevation.
- III.1.4. Asset data tables are required for all valves, hydrants, meter boxes, manholes, vaults, vacuum pods, locate wire boxes and fittings. Private pump out assembly components are required to be included in the appropriate tables, (See end of section for data table examples. Data tables can be downloaded from [jea.com](http://jea.com).)
- III.1.5. Every valve, hydrant, meter box, manhole, vault, vacuum pod, locate wire box, private pump out assembly component and fitting on the as-built is to be numbered and referenced in the asset data table. Minimum font on data tables shall be 8 pts.

### **III.2. GRAVITY WASTEWATER SEWER SYSTEMS**

- III.2.1. The location of all piping, casings, wyes, tees, manholes, cleanouts and service points to the existing system shall be referenced by coordinates.
- III.2.2. The positional accuracy relative to the referenced published control points used shall not exceed 0.5' horizontally and 0.1' vertically. Elevations relative to the site facilities must be within 0.1' of each other.
- III.2.3. Runs of gravity sewer shall be identified (i.e., 300' of 8" PVC SDR26 at S=.004.) A run is defined as a pipe line between manholes.
- III.2.4. Service points shall be identified. A service point is defined as the lateral service point located at the transition from the public right of way or utility easement to private property at the property line. It is the point where JEA ownership ends and private ownership begins.
- III.2.5. Top of pipe elevations and finished grade elevations at the property line shall be given for all service points.
- III.2.6. Elevations shall be given for the north rim of the top of all manhole covers and all manhole inverts with the direction of the invert listed (N, E, S, W, NW, etc).
- III.2.7. Asset data tables are required for all gravity sewer runs, fittings on runs, service points and manholes. (See end of section for data table examples. Data tables can be downloaded from [jea.com](http://jea.com).)
- III.2.8. Every gravity sewer run fitting, service point, and manhole on the as-built shall be numbered and referenced in the asset data table. Minimum font on data tables shall be 8 pts.

# *JEA Water and Wastewater Standards*

## *501 As Built Drawings*

### **III.3. WATER, RECLAIMED AND WASTEWATER PUMP STATIONS**

- III.3.1. Wet well size and location shall be indicated and located relative to property lines and/or right-of-way lines.
- III.3.2. All utilities within the pump station site shall be located relative to property lines and/or right-of-way lines.
- III.3.3. The Contractor shall provide a boundary survey of the pump station site showing above and below ground improvements. This survey and sketch shall be prepared by a registered land surveyor in accordance with Chapter 472 of the Florida Statutes. The sketch shall be submitted with as-built drawings prior to pump station pre-start. The survey and sketch shall include:
  - III.3.3.1. Elevations shall be indicated at inverts, wet well top (rim elevation), wet well bottom, concrete slab corners and underground piping, valves and fittings.
  - III.3.3.2. All utilities materials and sizes of lines and fittings above and below ground shall be indicated.
  - III.3.3.3. As-built information shall be provided for the pump station site plan on a separate page. Within the pump station site plan/boundaries the following shall be located/drawn horizontally: all electrical panels (demarcation, control, distribution, meter can, disconnect/transfer switch(s), I/O and flow meter), emergency pump-outs, hose station, above and underground electrical conduit, piping, valves, ARVs, fittings, manholes, generator/pony pump and fuel tank (if applicable), transformer, irrigation system, fence, auxiliary electrical enclosures and flow meter as applicable.
- III.3.4. All schedules that show site information, wet well dimensions/data, pump/motor and electrical data and emergency pony pump/generator data shall be corrected to show the as-built condition and submitted with the pump station drawings.
- III.3.5. All buried electrical conduit shall be labeled and located including electrical service from utility transformer to station meter and to control panel.
- III.3.6. See Chapter IV. 2. - Section 433 for additional requirements.
- III.3.7. The Contractor shall submit "As-built" drawings prior to pump station pre-start-up.
- III.3.8. If the pump station is privately owned, provide a note on the drawing identifying the owner's name, address and phone number for future coordination tasks and emergency events.
- III.3.9. See Pump Station As-Built check list at end of chapter.

### **III.4. STORM DRAIN SYSTEMS**

- III.4.1. The location of all piping, manholes, and inlets, shall be referenced by coordinates.
- III.4.2. The positional accuracy relative to the referenced published control points used shall not exceed 0.5' horizontally and 0.1' vertically. Elevations relative to the site facilities must be within 0.1' of each other.

# *JEA Water and Wastewater Standards*

## *501 As Built Drawings*

- III.4.3. Runs of storm wastewaters shall be identified (i.e., 300' of 15" RCP at S=.004.)
- III.4.4. Elevations shall be given for the north rim of the top of all manhole covers and inlets and catch basins and all manhole, inlet and catch basin inverts.
- III.4.5. Storm Drain, manhole, inlet and catch basin types shall be identified.

### **III.5. BUILDINGS AND INTERIOR EQUIPMENT**

- III.5.1. As-built drawings for buildings shall be marked to indicate any and all changes made. As-built drawings shall also include the installed size, elevation and location of all interior equipment, structures and concealed materials, including plumbing, electrical conduits, ducts, air and piping. The piping shall be identified as to its use. Internal backflow devices shall be clearly noted in drawings.
- III.5.2. All equipment shall have equipment attribute forms for each asset type completed.

### **III.6. HORIZONTAL DIRECTIONAL DRILL (HDD)**

The beginning and ending points of the HDD main shall be provided by a registered Professional Surveyor and Mapper. The HDD contractor shall provide a JEA approved certified as-built drawing, directional bore log plan and profile on a 24 x 36 sheet and Auto CAD file (certified by the HDD contractor) of the HDD work indicating horizontal and vertical location data (continuous or data points not to exceed 25 LF of main). A copy of the bore log shall be placed on the correct "As-built" sheet where drills are performed. An electronic PDF file containing this same information shall also be provided. See Chapter VI. 2. - Section 750 for additional requirements.

## **IV. ASSET SPECIFIC REQUIREMENTS**

### **IV.1. PIPELINES**

- IV.1.1. Each pipe segment shall show a call out designating each length, size, material and pressure class of pipe installed with leader pointing to the installed pipe. Short pipe segments (less than 20 feet long) contained between fittings/valves can have the pipe length description and leader line grouped in one descriptive note with leader line pointing to the group of pipes/fittings/valves.
- IV.1.2. Pipe segments shall be defined as pipe lengths between valves, fittings, manholes, meter boxes, vacuum pods, pump stations, vaults, etc.
- IV.1.3. Lateral or service pipe segments shall be identified by a note on each page. Note shall describe the typical lateral/service size, pipe material, and pipe pressure class. Laterals/Services that deviate from the typical note shall have a pipe segment call out as described IV.1.1.
- IV.1.4. Gravity wastewater pipe segments shall be designated in a table, inserted in a conspicuous location within the As-Built, with the following data. Minimum font on as-built data tables shall be 8 pts.
  - Sewer Pipe Run Number
  - Sewer Pipe Subtype = Collection, Trunk
  - Facility Owner (JEA or PRIVATE)

# *JEA Water and Wastewater Standards*

## *501 As Built Drawings*

- Pipe Size (Inches)
- Pipe Class (SDR26, etc)
- Pipe Material (PVC, etc.)
- Pipe Manufacturer
- Pipe Length (feet)
- Downstream Pipe Invert Elevation (feet)
- Downstream Grade Elevation at Invert (feet)
- Upstream Pipe Invert Elevation (feet)
- Upstream Grade Elevation at Invert (feet)
- Slope (ft/ft)

IV.1.5. Gravity wastewater pipe table shall also be submitted in excel format using the JEA standard excel file which can be downloaded from [jea.com](http://jea.com). See end of section for data table examples.

### **IV.2. FITTINGS**

IV.2.1. Each fitting shall show a call out designating fitting number, fitting type (45, tee, etc.) and size with leader pointing to the installed fitting. Multiple fittings in close proximity can be grouped with one leader line. A blow-up section may be required to accurately depict all fittings in a congested area.

IV.2.2. Fittings shall be designated in a fitting table, inserted in a conspicuous location within the As-Built, with the following data. Minimum font on as-built data tables shall be 8 pts. Provide a separate fitting table for water fittings, wastewater fittings, reclaimed water fittings and chilled water fittings.

- Fitting Number
- Subtype = Fitting Type (see data table file for subtypes)
- Facility Owner (JEA or PRIVATE)
- Fitting Size Primary (Inches)
- Fitting Size Secondary (Inches)
- Fitting Type
- Manufacturer
- Fitting Material (DIMJ, PVC or HDPE)
- Lining Material
- Fitting Top Elevation (feet)
- Final Grade Elevation (feet)
- Fitting Depth (feet)
- State Plane Northing, Y Coord
- State Plane Easting, X Coord
- Latitude (in Decimal Degrees)
- Longitude (in Decimal Degrees)

IV.2.3. Fitting table shall also be submitted in excel format using the JEA standard excel file which can be downloaded from [jea.com](http://jea.com). See end of section for data table examples.

# *JEA Water and Wastewater Standards*

## *501 As Built Drawings*

### **IV.3. VALVES**

- IV.3.1. Each valve shall show a call out designating valve number, valve type, and valve size with leader pointing to the installed valve.
- IV.3.2. Each valve shall be designated in a valve table, inserted in a conspicuous location within the As-Built, with the following data. Minimum font on as-built data tables shall be 8 pts. Provide a separate valve table for water valves, wastewater valves, reclaimed valves and chilled water valves.
- Valve Number (WV, WWV, RV, CV)
  - Valve Subtype = Valve, ARV, Backflow, Hydrant
  - (See data file for subtypes)
  - Valve Type
  - Facility Owner (JEA or PRIVATE)
  - Valve Size
  - Valve Open Direction (left/right)
  - Valve number of turns required to open the valve
  - Valve Depth to Operating Nut
  - Final Grade Elevation (feet)
  - Valve Depth to Nut (feet)
  - Valve Manufacturer
  - State Plane Northing, Y Coord
  - State Plane Easting, X Coord
  - Latitude (in Decimal Degrees)
  - Longitude (in Decimal Degrees)
  - RFID/Barcode Number (future)
- IV.3.3. Valve table shall also be submitted in excel format using the JEA standard excel file which can be downloaded from [jea.com](http://jea.com). See end of section for data table examples.

### **IV.4. HYDRANTS**

- IV.4.1. Each hydrant shall show a call out designating hydrant number with leader pointing to the installed hydrant.
- IV.4.2. Each hydrant shall be designated in a hydrant table, inserted in a conspicuous location within the As-Built, with the following data. Minimum font on as-built data tables shall be 8 pts. Provide a separate hydrant table for water hydrants and reclaimed hydrants.
- Hydrant Number (WH, RH)
  - Hydrant Subtype = Hydrant
  - Facility Owner (JEA or PRIVATE)
  - Hydrant Manufacture Date (year)
  - Hydrant Manufacturer

# *JEA Water and Wastewater Standards*

## *501 As Built Drawings*

- State Plane Northing, Y Coord
- State Plane Easting, X Coord
- Latitude (in Decimal Degrees)
- Longitude (in Decimal Degrees)
- RFID/Barcode Number (future)

IV.4.3. Hydrant table shall also be submitted in excel format using the JEA standard excel file which can be downloaded from jea.com. See end of section for data table examples.

### **IV.5. MANHOLES**

IV.5.1. Each manhole shall show a call out designating manhole number, manhole type, manhole top elevation, invert elevations (with direction) with leader pointing to the installed manhole.

IV.5.2. Each manhole shall be designated in a manhole table, inserted in a conspicuous location within the As-Built, with the following data. Minimum font on as-built data tables shall be 8 pts.

- Manhole Number
- Manhole Subtype = Collection, Force main, Low Pressure, Trunk  
(See data file for subtypes)
- Facility Owner (JEA or PRIVATE)
- Manhole Type (A through J)
- Manhole Drop Type (Inside or Outside)
- Manufacturer/Supplier
- Manhole Size (feet)
- Manhole Material
- Manhole Lining Material
- Manhole Lining Manufacturer
- Rim Elevation (feet)
- Invert Elevations (feet) with Directions
- State Plane Northing, Y Coord
- State Plane Easting, X Coord
- Latitude (in Decimal Degrees)
- Longitude (in Decimal Degrees)
- Exterior Joint Tape Type & Manufacturer
- RFID/Barcode Number (future)

IV.5.3. Manhole table shall also be submitted in excel format using the JEA standard excel file which can be downloaded from jea.com. See end of section for data table examples.

### **IV.6. METERS AND METER BOXES**

IV.6.1. Each meter box shall be shown on the as-built drawings. The size meter to be installed in the meter box shall also be indicated adjacent to the meter box or meter box notes. Horizontal



# *JEA Water and Wastewater Standards*

## *501 As Built Drawings*

dimensioning on the as-built is not required if meter box is located as per standards and is in a residential subdivision.

IV.6.2. Each meter box shall be designated in a meter box table, inserted in a conspicuous location within the As-Built, with the following data. Minimum font on as-built data tables shall be 8 pts. Provide a separate meter box table for water and reclaimed water meter boxes.

- Meter Box Number
- Proposed meter size to be installed by JEA
- Service Type (Water or Reclaimed Water)
- Meter Subtype = Minor Meter (<2"), Major Meter
- Facility Owner (JEA or PRIVATE)
- Meter box manufacturer
- Meter Box Material
- State Plane Northing, Y Coord
- State Plane Easting, X Coord
- Latitude (in Decimal Degrees)
- Longitude (in Decimal Degrees)

\*\*For platted subdivisions with lot numbers on the as-builts, as-builts will not be required to identify each water meter or reclaimed meter individually at each point. The lot number combined with a meter prefix will be used to identify the customer points in the meter table.

IV.6.3. Meter box table shall also be submitted in excel format using the JEA standard excel file which can be downloaded from jea.com. See end of section for data table examples.

### **IV.7. WASTEWATER SERVICE POINTS**

IV.7.1. Each wastewater service lateral end point shall be shown on the as-built drawings. Horizontal dimensioning on the as-built is not required if service point is located as per standards and is in a residential subdivision.

IV.7.2. Each wastewater service points shall be designated in a wastewater service point table, inserted in a conspicuous location within the As-Built, with the following data. Minimum font on as-built data tables shall be 8 pts.

- Wastewater Service Point Number
- Wastewater Service Point Subtype = Customer point, Major Meter  
(See data table file for subtypes)
- Finished Grade Elevation (feet)
- Top of Pipe Elevation (feet)
- Depth of Cover (feet)
- State Plane Northing, Y Coord
- State Plane Easting, X Coord
- Latitude (in Decimal Degrees)
- Longitude (in Decimal Degrees)

# *JEA Water and Wastewater Standards*

## *501 As Built Drawings*

\*\*For platted subdivisions with lot numbers on the as-builts, as-builts will not be required to identify each wastewater connection point individually at each point. The lot number combined with a meter prefix will be used to identify the customer points in the meter table.

IV.7.3. Wastewater service point table shall also be submitted in excel format using the JEA standard excel file which can be downloaded from jea.com. See end of section for data table examples.

### **IV.8. LOCATE WIRE BOXES**

IV.8.1. Each locate wire box shall show a call out designating locate wire box number with leader pointing to the installed box.

IV.8.2. Each locate wire box shall be designated in a locate wire box table, inserted in a conspicuous location within the As-Built, with the following data. Minimum font on as-built data tables shall be 8 pts. Provide a separate locate wire box table for water, wastewater, reclaimed water and chilled water boxes.

- Locate Wire Box Number (WLW-, SLW-, RLW-, CWL-)
- Locate Box Subtype
- State Plane Northing, Y Coord
- State Plane Easting, X Coord
- Latitude (in Decimal Degrees)
- Longitude (in Decimal Degrees)

IV.8.3. Locate wire box table shall also be submitted in excel format using the JEA standard excel file which can be downloaded from jea.com. See end of section for data table examples.

### **IV.9. WASTEWATER, WATER, RECLAIMED WATER PUMPING STATIONS**

Wastewater, water, and reclaimed water standard attribute worksheets shall be submitted in excel format using the JEA standard excel file which can be downloaded from jea.com.

# JEA Water and Wastewater Standards 501 As Built Drawings

## IV.10. DATA TABLE EXAMPLES

Sample Gravity Wastewater Sewer Pipe Table:

Sewer Pipe Run #	Subtype Pipe Type	Facility Owner	Pipe Size (inches)	Pipe Class	Pipe Material	Pipe Manufacturer	Pipe Run Length (feet)	Downstream Pipe Invert Elevation (feet)	Downstream Grade Elevation at Invert (feet)	Upstream Pipe Invert Elevation (feet)	Upstream Grade Elevation at Invert (feet)	Slope (ft/ft)
GS1	Collection	JEA	8	SDR26	PVC	US Pipe	489.56	26.94	32.3	28.9	32.1	0.004
GS2	Collection	JEA	8	SDR26	PVC	US Pipe	499.34	24.86	32.4	26.81	32.3	0.0039
GS3	Collection	JEA	12	SDR26	PVC	US Pipe	375.76	23.60	33.2	24.73	32.4	0.003

Sample Fitting Table:

Fitting #	Subtype Fitting Type	Facility Owner	Fitting Size Primary (inch)	Fitting Size Second (Inch)	Fitting Type	Manufacturer	Fitting Material	Lining	Fitting Top Elev. (feet)	Final Grade Elev. (feet)	Bury Depth (feet)	State Plane X Coord (feet)	State Plane Y Coord (feet)	Latitude (Decimal Degrees)	Longitude (Decimal Degrees)
WF1	Elbow 90	JEA	8		Mechanical Joint	American	DI	Epoxy	9.4	12.5	3.1	455667.55	2193930.60	30.3669169	-81.77895000
WF3	Tee	JEA	8	4	Mechanical Joint	American	DI	Epoxy	9.4	12.5	3.1	455667.55	2193930.60	30.3669169	-81.77895000
WF4	Reducer	Private	12	6	Mechanical Joint	American	DI	Epoxy	8.4	11.5	3.1	455667.55	2193930.60	30.3669169	-81.7789500

## JEA Water and Wastewater Standards 501 As Built Drawings

Sample Water Valve Table:

Valve Number	Valve Subtype	Valve Type	Facility Owner	Valve Size	Valve Open Direction	Turns to Open	Op Nut Elevation (feet)	Final Grade Elevation (feet)	Valve Depth to Op Nut (feet)	Valve Manufacturer	State Plane X Coord (feet)	State Plane Y Coord (feet)	Latitude (Decimal Degrees)	Longitude (Decimal Degrees)	RFID / Barcode Number
WV1	Valve	Gate	JEA	6	Left	18	10.1	12.6	2.5	Clow	455667.55	2193930.60	30.366916944	-81.778950000	
WV2	Valve	Plug	JEA	6	Right	4	9.8	12.6	2.8	M&H	455667.55	2193930.60	30.366916944	-81.778950000	

Sample Hydrant Table:

Hydrant Number	Hydrant Subtype	Facility Owner	Hydrant Manufacture Date (year)	Hydrant Manufacturer	State Plane X Coord (feet)	State Plane Y Coord (feet)	Latitude (Decimal Degrees)	Longitude (Decimal Degrees)	RFID / Barcode Number
WH1	Hydrant	JEA	2017	Mueller	455667.55	2193930.60	30.366916944	-81.778950000	
WH2	Hydrant	JEA	2017	Mueller	455667.55	2193930.60	30.366916944	-81.778950000	
WH3	Hydrant	JEA	2017	Mueller	455667.55	2193930.60	30.366916944	-81.778950000	

Sample Manhole Table:

Manhole Number	Manhole Subtype	Facility Owner	Manhole Type	Manhole Drop Type	Manufacturer or Supplier	Manhole Size (feet)	Manhole Material	Manhole Lining Material	Manhole Liner Manufacturer	Rim Elevation (feet)	Invert Elevations (feet) with Directions	State Plane X Coord (feet)	State Plane Y Coord (feet)	Latitude (Decimal Degrees)	Longitude (Decimal Degrees)	Exterior Joint Tape Type & Manufacturer	RFID / Barcode Number
M1	Collection	JEA	A	N/A	Standard Precast	4	Precast	Epoxy		12.9	6.83 North 6.90 South 6.92 SW	455667.5	2193930.6	30.366916944	-81.778950000		
M2	Force main	JEA	A	N/A	Standard Precast	4	Precast	Spectrashield	Spectrashield	12.2	5.88 North	455667.5	2193930.6	30.366916944	-81.778950000		
M3	Collection	JEA	B	Inside	Standard Precast	4	Precast	Epoxy		12.6	6.23 North 8.11 South	455667.5	2193930.6	30.366916944	-81.778950000		

## JEA Water and Wastewater Standards 501 As Built Drawings

Sample Water Meter Box Table:

Meter Type & Lot Number	Service Type	Proposed Meter Size	Meter Box Subtype	Facility Owner	Meter Box Manufacturer/Supplier	Meter Box Material	State Plane X Coord (feet)	State Plane Y Coord (feet)	Latitude (Decimal Degrees)	Longitude (Decimal Degrees)
WM1	Water	1 ½"	Minor Meter	JEA	Glassmasters	Polymer	455667.55	2193930.60	30.366916944	-81.778950000
WM2	Water	1 ½"	Major Meter	JEA	Glassmasters	Concrete	455667.55	2193930.60	30.366916944	-81.778950000

Sample Wastewater Service Point Table:

Wastewater Service Point Type & Lot Number	Service Point Subtype	Finished Grade Elevation at Service Point (feet)	Top of Pipe Elevation at Service Point (feet)	Depth of Cover (feet)	State Plane X Coord (feet)	State Plane Y Coord (feet)	Latitude (Decimal Degrees)	Longitude (Decimal Degrees)
WWSP1	Customer Point	12.9	10.4	2.5	455667.55	2193930.60	30.366916944	-81.778950000
WWSP2	Customer Point	12.2	8.6	3.6	455667.55	2193930.60	30.366916944	-81.778950000
WWSP3	Customer Point	12.6	10.4	2.5	455667.55	2193930.60	30.366916944	-81.778950000

Sample Locate Wire Box Table:

Locate Box Number	Locate Box Subtype	State Plane X Coord (feet)	State Plane Y Coord (feet)	Latitude (Decimal Degrees)	Longitude (Decimal Degrees)
WH1	Locate Wire Box	455667.55	2193930.60	30.366916944	-81.778950000
WH2	Locate Wire Box	455667.55	2193930.60	30.366916944	-81.778950000
WH3	Locate Wire Box	455667.55	2193930.60	30.366916944	-81.778950000

Sample Reclaimed Meter Box Table:

Meter Type & Lot Number	Service Type	Proposed Meter Size	Meter Box Subtype	Facility Owner	Meter Box Manufacturer/Supplier	Meter Box Material	State Plane X Coord (feet)	State Plane Y Coord (feet)	Latitude (Decimal Degrees)	Longitude (Decimal Degrees)
RM1	Reclaimed	1 ½"	Minor Meter	JEA	Glassmasters	Polymer	455667.55	2193930.60	30.366916944	-81.778950000
RM2	Reclaimed	1 ½"	Minor Meter	JEA	Glassmasters	Polymer	455667.55	2193930.60	30.366916944	-81.778950000
RM3	Reclaimed	1 ½"	Minor Meter	JEA	Glassmasters	Polymer	455667.55	2193930.60	30.366916944	-81.778950000

# JEA Water and Wastewater Standards

## 501 As-Built Drawings

### V. SUBMITTAL TRANSMITTALS AND CHECKLISTS

#### V.1. AS-BUILT OR RECORD DRAWING CERTIFICATION BLOCKS:

The following information (as applicable) shall be displayed on each page of the As-Built or Record drawing set. For preliminary as-built or record drawing review, all fields must be filled out including signature, date and license numbers. The seal must be supplied on the final approved as built.

##### V.1.1. FOR ENGINEERS:

<b>AS-BUILT</b>	
INFORMATION PROVIDED BY:	
Date:	_____
Name:	_____
Address	_____
Phone#:	_____
<u>I HEREBY CERTIFY THAT THE</u>	
_____ Pavement _____ Curb & Gutter _____ Storm & Drainage System _____ Lake or Pond _____ Underdrain Connections	_____ Chilled Water _____ Water Main _____ Reclaimed Water Main _____ Force Main _____ Sanitary Gravity System _____ Lift Station
ARE AT THE HORIZONTAL AND VERTICAL LOCATIONS AS SHOWN ON THESE "AS-BUILT" DRAWINGS <u>AND THE ACCOMPANYING ELECTRONIC FILES HAVE BEEN LOCATED AND MAPPED</u> IN ACCORDANCE WITH CHAPTER 471 OF FLORIDA STATUTES, CHAPTER 61G15-23 OF THE FLORIDA BOARD OF PROFESSIONAL ENGINEERS AND THE JEA STANDARDS FOR AS-BUILT DRAWINGS.	
ELECTRONIC DRAWING FILE NAME: _____	
FILE DATE: _____	
DATE OF FIELD SURVEY _____	
SIGNATURE: _____	
NAME: _____	
FLORIDA PROFESSIONAL ENGINEER NO: _____	

# JEA Water and Wastewater Standards

## 501 As-Built Drawings

### V.1.2. FOR SURVEYORS:

<b>AS-BUILT</b>	
INFORMATION PROVIDED BY: _____	
Name: _____	_____
Address: _____	_____
Phone#: _____	_____
I HEREBY CERTIFY THAT THE	
_____ Pavement	_____ Chilled Water
_____ Curb & Gutter	_____ Water Main
_____ Storm & Drainage System	_____ Reclaimed Water Main
_____ Lake or Pond	_____ Force Main
_____ Underdrain Connections	_____ Sanitary Gravity System
_____	_____ Lift Station
ARE AT THE HORIZONTAL AND VERTICAL LOCATIONS AS SHOWN ON THESE "AS-BUILT" DRAWINGS AND MEET THE <u>MINIMUM</u> TECHNICAL STANDARDS FOR SURVEYING AND MAPPING IN THE STATE OF FLORIDA AS PER CHAPTER 5J-17.051 AND 5J-17.052, F.A.C.	
ELECTRONIC DRAWING FILE NAME: _____	
FILE DATE: _____	
DATE OF FIELD SURVEY: _____	
SURVEYOR'S SIGNATURE: _____	
SURVEYOR'S NAME: _____	
PSM#: _____	
THIS REPORT AND DIGITAL FILE ARE NOT FULL AND COMPLETE WITHOUT THE OTHER AND ARE NOT VALID WITHOUT THE SIGNATURE AND ORIGINAL RAISED SEAL OF THE FLORIDA LICENSED SURVEYOR AND MAPPER.	

# JEA Water and Wastewater Standards

## 501 As-Built Drawings

### V.1.3. FOR CONTRACTORS:

<b>AS-BUILT</b>	
INFORMATION PROVIDED BY:	
Date:	_____
Name:	_____
Address	_____
	_____
Phone#:	_____
	_____
I HEREBY CERTIFY THAT THE MATERIALS AND QUANTITIES USED IN THE CONSTRUCTION OF:	
_____ Pavement	_____ Chilled Water
_____ Curb & Gutter	_____ Water Main
_____ Storm & Drainage System	_____ Reclaimed Water Main
_____ Lake or Pond	_____ Force Main
_____ Underdrain Connections	_____ Sanitary Gravity System
	_____ Lift Station
ARE IN ACCORDANCE WITH THE APPROVED PLANS AND JEA STANDARDS AND COUNTY SPECIFICATIONS, UNLESS OTHERWISE APPROVED BY THE REGULATORY AGENCY.	
CONTRACTOR'S SIGNATURE: _____	
CONTRACTOR'S NAME: _____	
CONTRACTOR'S STATE UTILITIES LICENSE NUMBER: _____	



# JEA Water and Wastewater Standards

## 501 As-Built Drawings

### V.1.4. FOR PROJECT MANAGERS:

<b>RECORD DRAWING</b>	
INFORMATION PROVIDED BY:	
Date:	_____
Name:	_____
Address	_____
	_____
Phone#:	_____
	_____
I HEREBY CERTIFY THAT THE MATERIALS AND QUANTITIES USED IN THE CONSTRUCTION OF:	
_____ Pavement	_____ Chilled Water
_____ Curb & Gutter	_____ Water Main
_____ Storm & Drainage System	_____ Reclaimed Water Main
_____ Lake or Pond	_____ Force Main
_____ Underdrain Connections	_____ Sanitary Gravity System
	_____ Lift Station
ARE IN ACCORDANCE WITH THE APPROVED PLANS AND JEA STANDARDS AND COUNTY SPECIFICATIONS, UNLESS OTHERWISE APPROVED BY THE REGULATORY AGENCY. INFRASTRUCTURE IS AT THE HORIZONTAL AND VERTICAL LOCATIONS AS SHOWN ON THESE "RECORD" DRAWINGS.	
JEA PROJECT MANAGER'S SIGNATURE: _____	
JEA PROJECT MANAGER'S NAME: _____	

# *JEA Water and Wastewater Standards*

## *501 As-Built Drawings*

### V.2. JEA AS-BUILT OR RECORD DRAWING SUBMITTAL TRANSMITTAL

Water / Wastewater / Reclaimed Water / Chilled Water Pipes and Pumping

To: W&S As-Built Submittal Mailbox

From: \_\_\_\_\_

Phone: \_\_\_\_\_ E-mail: \_\_\_\_\_

Company Name: \_\_\_\_\_

Company Address \_\_\_\_\_

Date of Submittal: \_\_\_\_\_

Signature of Submitter \_\_\_\_\_

Verifying Compliance: \_\_\_\_\_

Project Name: \_\_\_\_\_

Project Type: \_\_\_\_\_ New Development    \_\_\_\_\_ Treatment Plant    \_\_\_\_\_ JEA Installed    \_\_\_\_\_ JEA Contractor  
(Check all that apply)

Project Purpose \_\_\_\_\_ Main Extension    \_\_\_\_\_ Main Replacement    \_\_\_\_\_ Main Relocation    \_\_\_\_\_ Plant Project

JEA Availability \_\_\_\_\_ JEA Capital Project  
Number: \_\_\_\_\_ Number: \_\_\_\_\_

JEA Project Manager: \_\_\_\_\_ JEA PM e-mail: \_\_\_\_\_

Engineering Firm: \_\_\_\_\_

Engineering Contact: \_\_\_\_\_

Engineers Phone: \_\_\_\_\_

Engineers E-mail: \_\_\_\_\_

Contracting Co.: \_\_\_\_\_

Contractor Contact: \_\_\_\_\_

Contractor Phone: \_\_\_\_\_

Contractor E-Mail: \_\_\_\_\_

Surveying Co.: \_\_\_\_\_

Surveyor Contact: \_\_\_\_\_

Surveyors Phone: \_\_\_\_\_

Surveyors E-mail: \_\_\_\_\_

JEA O&M representative: \_\_\_\_\_

- Attached: \_\_\_\_\_ Water As-Builts & Data Tables – Paper & Electronic  
\_\_\_\_\_ Wastewater As-Builts & Data Tables – Paper & Electronic  
\_\_\_\_\_ Wastewater Pump Station Attribute Tables Electronic  
\_\_\_\_\_ Reclaimed Water As-Builts & Data Tables – Paper & Electronic  
\_\_\_\_\_ Chilled Water As-Builts & Data Tables – Paper & Electronic  
\_\_\_\_\_ As-Built Submittal Checklist filled out by Engineer, Contractor or Surveyor  
\_\_\_\_\_ As-Built Submittal Checklist filled out by JEA Project Manager  
\_\_\_\_\_ Equipment Attribute Worksheets completed

# JEA Water and Wastewater Standards

## 501 As-Built Drawings

### V.3. JEA AS-BUILT OR RECORD DRAWING SUBMITTAL REQUIREMENTS CHECK LIST PIPELINES AND PUMPING STATIONS

Project Name: \_\_\_\_\_

JEA Availability Number: \_\_\_\_\_ JEA Capital Project Number: \_\_\_\_\_

*Initial next to each requirement verifying compliance*

\_\_\_\_\_ Separate As-Builts or record drawings for water, wastewater, reclaimed water and chilled water

\_\_\_\_\_ On each page of as-built, certification filled out, signed, sealed and dated by surveyor/mapper

\_\_\_\_\_ On each page of as-built, certification filled out, signed and dated by contractor

\_\_\_\_\_ On each page of record drawing, certification filled out, signed and dated by JEA project manager

\_\_\_\_\_ Old lines not built as per design deleted and redrawn as constructed

\_\_\_\_\_ Notes and elevations not struck through, but changed

\_\_\_\_\_ "AS-BUILT" or "RECORD DRAWING" labeled in 1" letters on each page

\_\_\_\_\_ Sheets are 24" x 36" in size

\_\_\_\_\_ Includes all changes by Addendum or Change Order or SWA (Supplemental Work Allowance)

\_\_\_\_\_ As-Built Includes datum & reference to state plane coordinates (Florida East Zone NAD 83, NAVD 88)

\_\_\_\_\_ Vicinity map on cover page

\_\_\_\_\_ Street names on all streets

\_\_\_\_\_ North Arrow on each page

\_\_\_\_\_ Graphic Scale on each page

\_\_\_\_\_ Availability number and/or JEA Capital Project number on each page

\_\_\_\_\_ JEA easements labeled as such, including RE number and Official Records Book and Page (OR #).

\_\_\_\_\_ Title page includes JEA Availability Number and/or JEA Oracle Project Numbers

\_\_\_\_\_ Date of utility installation completion on each page

\_\_\_\_\_ Ownership transition point between JEA and Private system clearly designated on the as-built drawing.

\_\_\_\_\_ Master Plan showing phasing for the entire development

\_\_\_\_\_ Match lines shown for continuation to other sheets

\_\_\_\_\_ Private utilities installed as part of this project shown

\_\_\_\_\_ Call outs provided showing points of connection to existing JEA infrastructure.

\_\_\_\_\_ Water pressure and/or force main pressure sensors are identified.

# JEA Water and Wastewater Standards

## 501 As-Built Drawings

### POTABLE WATER SYSTEMS

---

#### WATER MAINS

\_\_\_\_\_ Elevations on the main and finished grade shown at:

- Points of connection to the existing system
- Points of crossing over or under wastewater mains, reclaimed mains, chilled water mains or storm drains
- At maximum of 100 ft. intervals
- Where less than 30 inches or greater than 48 inches of cover is provided
- Main stub outs

\_\_\_\_\_ Each water main section between fittings/valves is shown with pipe size, pipe material and pipe pressure class called out with a leader line pointing to the applicable main or group of mains for mains between fittings less than 10 feet apart.

\_\_\_\_\_ Pipe size and type indicated on service lateral piping

\_\_\_\_\_ Beginning and end points of horizontal directional drills located by professional surveyor

\_\_\_\_\_ HDD (Horizontal directional drill) bore log included showing:

- Bore in plan and profile view
- Bore log on 24" x 36" sheets
- Certified by HDD contractor
- Horizontal and vertical location data at 25 ft. intervals (max)

#### WATER FITTINGS

\_\_\_\_\_ Each fitting shows a call out designating fitting number, fitting type (45, tee, etc.) and size with leader pointing to the installed fitting.

\_\_\_\_\_ Table included with data for each fitting:

- Fitting Number
- Subtype = Fitting Type (see data table file for subtypes)
- Facility Owner (JEA or PRIVATE)
- Fitting Size Primary (Inches)
- Fitting Size Secondary (Inches)
- Fitting Type
- Manufacturer
- Fitting Material (DIMJ, PVC or HDPE)
- Lining Material
- Fitting Top Elevation (feet)
- Final Grade Elevation (feet)
- Fitting Depth (feet)
- State Plane Northing, Y Coord
- State Plane Easting, X Coord
- Latitude (in Decimal Degrees)
- Longitude (in Decimal Degrees)

# *JEA Water and Wastewater Standards*

## *501 As-Built Drawings*

### WATER VALVES

Each valve shows a call out designating valve number, valve type, and valve size with leader pointing to the installed valve.

Table included with data for each valve:

- Valve Number (WV, WWV, RV, CV)
- Valve Subtype = Valve, ARV, Backflow, Hydrant
- Valve Type
- Facility Owner (JEA or PRIVATE)
- Valve Size
- Valve Open Direction (left/right)
- Valve number of turns required to open the valve
- Valve Depth to Operating Nut
- Final Grade Elevation (feet)
- Valve Depth to Nut (feet)
- Valve Manufacturer
- State Plane Northing, Y Coord
- State Plane Easting, X Coord
- Latitude (in Decimal Degrees)
- Longitude (in Decimal Degrees)
- RFID/Barcode Number (future)

### WATER HYDRANTS

Each hydrant shows a call out designating hydrant number with leader pointing to the installed hydrant.

Table included with data for each hydrant:

- Hydrant Number (WH, RH)
- Hydrant Subtype = Hydrant
- Facility Owner (JEA or PRIVATE)
- Hydrant Manufacture Date (year)
- Hydrant Manufacturer
- State Plane Northing, Y Coord
- State Plane Easting, X Coord
- Latitude (in Decimal Degrees)
- Longitude (in Decimal Degrees)
- RFID/Barcode Number (future)

# *JEA Water and Wastewater Standards*

## *501 As-Built Drawings*

### WATER METERS AND METER BOXES

Each meter box shall be listed in the data table with meter number matching the Lot #. If no Lot # exists, assign a water meter ID not included in the Lot # series. Show this meter ID at the meter on the as-built and in the data table.

Location of meter boxes indicated and referenced to property lines (not necessary for 2 inch or less residential meters located as per standards).

The size meter to be installed for each meter

Table included with data for each water meter box:

- Meter Box Number
- Proposed Meter Size
- Service Type (Water or Reclaimed Water)
- Meter Subtype = Minor Meter (<2"), Major Meter
- Facility Owner (JEA or PRIVATE)
- Meter box manufacturer
- Meter Box Material
- State Plane Northing, Y Coord
- State Plane Easting, X Coord
- Latitude (in Decimal Degrees)
- Longitude (in Decimal Degrees)

### WATER LOCATE WIRE BOXES

Each locate wire box shows a call out designating locate wire box number with leader pointing to the installed box

Table included with data for each locate wire box:

- Locate Wire Box Number (WLW-.)
- State Plane Northing, Y Coord
- State Plane Easting, X Coord
- Latitude (in Decimal Degrees)
- Longitude (in Decimal Degrees)

# JEA Water and Wastewater Standards

## 501 As-Built Drawings

### WASTEWATER SYSTEMS

---

#### GRAVITY MAINS

Elevations on the main and finished grade shown at:

- Points of connection to the existing system
- Points of crossing over or under water mains, reclaimed mains, chilled water mains, wastewater mains or storm drains
- Lateral (service) end points
- Main stub outs

Vertical separation called out at crossings with water mains

Plan and profile drawings provided showing pipe and manholes

Each gravity wastewater main section between manholes is shown with pipe size, pipe material, pipe pressure class, pipe length and slope called out with a leader line pointing to the applicable main.

Pipe type and size and finished grade elevations on service lateral piping shown.

The location of the service point for each lateral located from the side property line or by station and offset.

Table included with data for each gravity main:

- Sewer Pipe Run Number
- Sewer Pipe Subtype = Collection, Trunk
- Facility Owner (JEA or PRIVATE)
- Pipe Size (Inches)
- Pipe Class (SDR26, etc)
- Pipe Material (PVC, etc.)
- Pipe Manufacturer
- Pipe Length (feet)
- Downstream Pipe Invert Elevation (feet)
- Downstream Grade Elevation at Invert (feet)
- Upstream Pipe Invert Elevation (feet)
- Upstream Grade Elevation at Invert (feet)
- Slope (ft/ft)

# JEA Water and Wastewater Standards

## 501 As-Built Drawings

### GRAVITY FITTINGS

\_\_\_\_\_ Each fitting shall be listed in the sewer fitting data table with fitting number matching the Lot #. If no Lot # exists, assign a fitting number ID not included in the Lot # series. Show this fitting number ID at the fitting on the as-built and in the fitting data table.

\_\_\_\_\_ Table included with data for each fitting:

- Fitting Number (matching lot number)
- Subtype = Fitting Type (see data table file for subtypes)
- Facility Owner (JEA or PRIVATE)
- Fitting Size Primary (Inches)
- Fitting Size Reducer (Inches)
- Manufacturer
- Fitting Material (DI, PVC or HDPE)
- Lining Material
- Fitting Top Elevation (feet)
- Final Grade Elevation (feet)
- State Plane Northing, Y Coord
- State Plane Easting, X Coord
- Latitude (in Decimal Degrees)
- Longitude (in Decimal Degrees)

### MANHOLES & CLEANOUTS

\_\_\_\_\_ Elevations of inverts and north rim of top of manhole covers shown for all manholes at the manhole

\_\_\_\_\_ Manholes and cleanouts labeled with number at manhole or cleanout

\_\_\_\_\_ Air release valve manholes shown and listed in manhole data table (if applicable)

\_\_\_\_\_ Table with the following data for each manhole:

- Manhole Number
- Manhole Subtype = Collection, Force main, Low Pressure, Trunk, ARV
- Facility Owner (JEA or PRIVATE)
- Manhole Type (A through J)
- Manhole Drop Type (Inside or Outside)
- Manufacturer/Supplier
- Manhole Size (feet)
- Manhole Material
- Manhole Lining Material
- Manhole Lining Manufacturer
- Rim Elevation (feet)
- Invert Elevations (feet) with Directions
- State Plane Northing, Y Coord
- State Plane Easting, X Coord
- Latitude (in Decimal Degrees)
- Longitude (in Decimal Degrees)
- Exterior Joint Tape Type & Manufacturer
- RFID/Barcode Number (future)



# *JEA Water and Wastewater Standards*

## *501 As-Built Drawings*

### WASTEWATER SERVICE POINTS

\_\_\_\_\_ Each service point (sewer lateral end point) shall be listed in the data table with meter number matching the Lot #. If no Lot # exists, assign a water meter ID not included in the Lot # series. Show this meter ID at the meter on the as-built and in the data table.

\_\_\_\_\_ Table included with data for each wastewater service point:

- Wastewater Service Point Number
- Wastewater Service Point Subtype = Customer point, Major Meter  
(See data table file for subtypes)
- Finished Grade Elevation (feet)
- Top of Pipe Elevation (feet)
- Depth of Cover (feet)
- State Plane Northing, Y Coord
- State Plane Easting, X Coord
- Latitude (in Decimal Degrees)
- Longitude (in Decimal Degrees)

### WASTEWATER FORCE MAINS

\_\_\_\_\_ Elevations on the main and finished grade shown at:

- Points of connection to the existing system
- Points of crossing over or under water mains, reclaimed mains, chilled water mains, wastewater mains or storm drains
- At maximum of 100 ft. intervals
- Where less than 30 inches or greater than 48 inches of cover is provided.
- Main stub-outs

\_\_\_\_\_ Each force main section between fittings/valves is shown with pipe size, pipe material and pipe pressure class called out with a leader line pointing to the applicable main or group of mains for mains between fittings less than 10 feet apart.

Beginning and end points of HDD (horizontal directional drills) located by professional surveyor

\_\_\_\_\_ HDD bore log included showing:

- Bore in plan and profile view
- Bore log on 24" x 36" sheets
- Certified by HDD contractor
- Horizontal and vertical location data continuous or at no more than 25 ft. intervals

# *JEA Water and Wastewater Standards*

## *501 As-Built Drawings*

### FORCE MAIN FITTINGS

Each fitting shows a call out designating fitting number, fitting type (45, tee, etc.) and size with leader pointing to the installed fitting.

Table included with data for each fitting:

- Fitting Number
- Subtype = Fitting Type (see data table file for subtypes)
- Facility Owner (JEA or PRIVATE)
- Fitting Size Primary (Inches)
- Fitting Size Reducer (Inches)
- Manufacturer
- Fitting Material (DI, PVC or HDPE)
- Lining Material
- Fitting Top Elevation (feet)
- Final Grade Elevation (feet)
- State Plane Northing, Y Coord
- State Plane Easting, X Coord
- Latitude (in Decimal Degrees)
- Longitude (in Decimal Degrees)

### WASTEWATER VALVES

Each valve shows a call out designating valve number, valve type, and valve size with leader pointing to the installed valve.

Table included with data for each valve:

- Valve Number (WV, WWV, RV, CV)
- Valve Subtype = Valve, ARV, Backflow, Hydrant  
(See data table file for subtypes)
- Valve Type
- Facility Owner (JEA or PRIVATE)
- Valve Size
- Valve Open Direction (left/right)
- Valve number of turns required to open the valve
- Valve Depth to Operating Nut
- Final Grade Elevation (feet)
- Valve Depth to Nut (feet)
- Valve Manufacturer
- State Plane Northing, Y Coord
- State Plane Easting, X Coord
- Latitude (in Decimal Degrees)
- Longitude (in Decimal Degrees)
- RFID/Barcode Number (future)

# *JEA Water and Wastewater Standards*

## *501 As-Built Drawings*

### WASTEWATER LOCATE WIRE BOXES

Each locate wire box shows a call out designating locate wire box number with leader pointing to the installed box

Table included with data for each locate wire box:

- Locate Wire Box Number (WLW-.)
- State Plane Northing, Y Coord
- State Plane Easting, X Coord
- Latitude (in Decimal Degrees)
- Longitude (in Decimal Degrees)

# *JEA Water and Wastewater Standards*

## *501 As-Built Drawings*

### WASTEWATER PUMPING STATIONS

\_\_\_\_\_ Pump Station sheet is digital (not scanned and marked up) and legible when zoomed in.

\_\_\_\_\_ All As-Built changes are marked with AB and clouded. Corrected in AUTOCAD file, not crossed out with the new numbers.

\_\_\_\_\_ All pump station data/information is included on first sheet and the station layout with measurements, elevations and GPS coordinates on second sheet.

\_\_\_\_\_ All utilities within the pump station site are located relative to property lines.

\_\_\_\_\_ Elevations (\*and GPS coordinates) indicated at:

- Invert(s)
- Wet well Top (rim elevation) \*
- Wet well bottom
- Concrete slab station corners
- Underground piping, valves\* and fittings\*

\_\_\_\_\_ Measurements of panels & equipment relative to the concrete edges of station at:

- Control Panel Rack
- Power Distribution Rack
- Demarcation Box(s)
- Flow Meter Panel

\_\_\_\_\_ Above and below ground piping

\_\_\_\_\_ Wet Well shown and dimensioned from property lines

\_\_\_\_\_ Generator/Pony pump shown and information filled out

\_\_\_\_\_ Driveway shown and dimensioned from property lines

\_\_\_\_\_ All materials, sizes of lines and fittings associated with pump station are indicated on drawings.

\_\_\_\_\_ All buried electrical conduit labeled and located, including electrical service from utility transformer to station meter and to control panel.

\_\_\_\_\_ Pump information has been checked for completeness and accuracy

\_\_\_\_\_ MCC Panel chart is filled out.

\_\_\_\_\_ Schedule of elevation chart is filled out entirely.

\_\_\_\_\_ Station physical address is indicated in Pump Station Information box.

\_\_\_\_\_ Privately owned pump stations will provide pump model info for modeling purposes.

\_\_\_\_\_ Water pressure and/or force main pressure sensors are identified.

# *JEA Water and Wastewater Standards*

## *501 As-Built Drawings*

### **RECLAIMED WATER SYSTEMS**

---

#### **RECLAIMED WATER MAINS**

Elevations on the main and finished grade shown at:

- Points of connection to the existing system
- Points of crossing over or under water mains, reclaimed mains, chilled water mains, wastewater mains or storm drains
- At maximum of 100 ft. intervals
- Where less than 30 inches or greater than 48 inches of cover is provided
- Main stub-outs

Each reclaimed water main section between fittings/valves is shown with pipe size, pipe material and pipe pressure class called out with a leader line pointing to the applicable main or group of mains for mains between fittings less than 10 feet apart.

Pipe size and type indicated on service lateral piping

Location of reclaim signage indicating reclaim water in use

Location of meter boxes indicated and referenced to property lines (not necessary for 2 inch or less residential meters located as per standards).

Beginning and end points of horizontal directional drills located by professional surveyor

HDD (Horizontal directional drill) bore log included showing:

- Bore in plan and profile view
- Bore log on 24" x 36" sheets
- Certified by HDD contractor
- Horizontal and vertical location data at 25 ft. intervals (max)

#### **RECLAIMED WATER FITTINGS**

Each fitting shows a call out designating fitting number, fitting type (45, tee, etc.) and size with leader pointing to the installed fitting.

Table included with data for each fitting:

- Fitting Number
- Subtype = Fitting Type (see data table file for subtypes)
- Facility Owner (JEA or PRIVATE)
- Fitting Size Primary (Inches)
- Fitting Size Reducer (Inches)
- Manufacturer
- Fitting Material (DI, PVC or HDPE)
- Lining Material
- Fitting Top Elevation (feet)
- Final Grade Elevation (feet)
- State Plane Northing, Y Coord
- State Plane Easting, X Coord
- Latitude (in Decimal Degrees)
- Longitude (in Decimal Degrees)

# *JEA Water and Wastewater Standards*

## *501 As-Built Drawings*

### RECLAIMED WATER VALVES

Each valve shows a call out designating valve number, valve type, and valve size with leader pointing to the installed valve.

Table included with data for each valve:

- Valve Number (WV, WWV, RV)
- Valve Subtype = Valve, ARV, Backflow, Hydrant  
(See data table file for subtypes)
- Valve Type
- Facility Owner (JEA or PRIVATE)
- Valve Size
- Valve Open Direction (left/right)
- Valve number of turns required to open the valve
- Operating Nut Elevation (feet)
- Final Grade Elevation (feet)
- Depth to Op Nut (feet)
- Current Status (Open/Closed)
- Valve Manufacturer
- State Plane Northing, Y Coord
- State Plane Easting, X Coord
- Latitude (in Decimal Degrees)
- Longitude (in Decimal Degrees)
- RFID/Barcode Number (future)

### RECLAIMED WATER HYDRANTS

Each hydrant shows a call out designating hydrant number with leader pointing to the installed hydrant.

Table included with data for each hydrant:

- Hydrant Number (WH, RH)
- Hydrant Subtype = Hydrant
- Facility Owner (JEA or PRIVATE)
- Hydrant Manufacture Date (year)
- Hydrant Manufacturer
- State Plane Northing, Y Coord
- State Plane Easting, X Coord
- Latitude (in Decimal Degrees)
- Longitude (in Decimal Degrees)
- RFID/Barcode Number (future)

# *JEA Water and Wastewater Standards*

## *501 As-Built Drawings*

### **RECLAIMED WATER METER BOXES**

\_\_\_\_\_ Each meter box shall be listed in the data table with meter number matching the Lot #. If no Lot # exists, assign a reclaimed water meter ID not included in the Lot # series. Show this meter ID at the meter on the as-built and in the data table.

\_\_\_\_\_ The size meter to be installed for each meter

\_\_\_\_\_ Table included with data for each meter box:

- Meter Box Number
- Proposed Meter Size
- Service Type (Water or Reclaimed Water)
- Meter Subtype = Minor Meter (<2"), Major Meter
- Facility Owner (JEA or PRIVATE)
- Meter box manufacturer
- Meter Box Material
- State Plane Northing, Y Coord
- State Plane Easting, X Coord
- Latitude (in Decimal Degrees)
- Longitude (in Decimal Degrees)

### **RECLAIMED WATER LOCATE WIRE BOXES**

\_\_\_\_\_ Each locate wire box shows a call out designating locate wire box number with leader pointing to the installed box

\_\_\_\_\_ Table included with data for each locate wire box:

- Locate Wire Box Number (WLW-.)
- State Plane Northing, Y Coord
- State Plane Easting, X Coord
- Latitude (in Decimal Degrees)
- Longitude (in Decimal Degrees)

# *JEA Water and Wastewater Standards*

## *501 As-Built Drawings*

### CHILLED WATER SYSTEMS

---

#### CHILLED WATER MAINS

- \_\_\_\_\_ Elevations on the main and finished grade shown at:
- Points of connection to the existing system
  - Points of crossing over or under water mains, reclaimed mains, chilled water mains, wastewater mains or storm drains
  - At maximum of 100 ft. intervals
  - Where less than 30 inches or greater than 48 inches of cover is provided
- \_\_\_\_\_ Each chilled water main section between fittings/valves is shown with pipe size, pipe material and pipe pressure class called out with a leader line pointing to the applicable main or group of mains for mains between fittings less than 10 feet apart.
- \_\_\_\_\_ Each pipe labeled as to supply water or return water
- \_\_\_\_\_ Pipe size and type indicated on service lateral piping
- \_\_\_\_\_ Location of lateral end points indicated and referenced to property lines.
- \_\_\_\_\_ Beginning and end points of horizontal directional drills located by professional surveyor
- \_\_\_\_\_ HDD (Horizontal directional drill) bore log included showing:
- Bore in plan and profile view
  - Bore log on 24" x 36" sheets
  - Certified by HDD contractor
  - Horizontal and vertical location data at 25 ft. intervals (max)

#### CHILLED WATER FITTINGS

- \_\_\_\_\_ Each fitting shows a call out designating fitting number, fitting type (45, tee, etc.) and size with leader pointing to the installed fitting.
- \_\_\_\_\_ Table included with data for each fitting:
- Fitting Number
  - Subtype = Fitting Type (see data table file for subtypes)
  - Facility Owner (JEA or PRIVATE)
  - Fitting Size Primary (Inches)
  - Fitting Size Reducer (Inches)
  - Manufacturer
  - Fitting Material (DI, PVC or HDPE)
  - Lining Material
  - Fitting Top Elevation (feet)
  - Final Grade Elevation (feet)
  - State Plane Northing, Y Coord
  - State Plane Easting, X Coord
  - Latitude (in Decimal Degrees)
  - Longitude (in Decimal Degrees)
  - RFID/Barcode Number (future)



# *JEA Water and Wastewater Standards*

## *501 As-Built Drawings*

### CHILLED WATER VALVES

Each valve shows a call out designating valve number, valve type, and valve size with leader pointing to the installed valve.

Table included with data for each valve:

- Valve Number (WV, WWV, RV)
- Valve Subtype = Valve, ARV, Backflow, Hydrant  
(See data table file for subtypes)
- Valve Type
- Facility Owner (JEA or PRIVATE)
- Valve Size
- Valve Open Direction (left/right)
- Valve number of turns required to open the valve
- Operating Nut Elevation (feet)
- Final Grade Elevation (feet)
- Depth to Op Nut (feet)
- Current Status (Open/Closed)
- Valve Manufacturer
- State Plane Northing, Y Coord
- State Plane Easting, X Coord
- Latitude (in Decimal Degrees)
- Longitude (in Decimal Degrees)
- RFID/Barcode Number (future)

### CHILLED WATER LOCATE WIRE BOXES

Each locate wire box shows a call out designating locate wire box number with leader pointing to the installed box

Table included with data for each locate wire box:

- Locate Wire Box Number (WLW-.)
- State Plane Northing, Y Coord
- State Plane Easting, X Coord
- Latitude (in Decimal Degrees)
- Longitude (in Decimal Degrees)

# *JEA Water and Wastewater Standards*

## *501 As-Built Drawings*

### STORM DRAIN SYSTEMS

---

#### STORM DRAIN

- \_\_\_\_\_ Runs of storm wastewaters identified with size, material and slope (i.e., 300' of 15" RCP at S=.004)
- \_\_\_\_\_ Elevations given for the north rim of the top of all manhole covers and inlets and catch basins and all manhole, inlet and catch basin inverts
- \_\_\_\_\_ All storm drain manholes, inlets and catch basin types identified

# JEA Water and Wastewater Standards

## 501 As-Built Drawings

### V.4. INSPECTION CHECKLIST: LOCATE WIRE BOXES

Project Name: \_\_\_\_\_

Street/Intersection/Address Location: \_\_\_\_\_

Station: \_\_\_\_\_ Offset: \_\_\_\_\_

Check the following as applicable

- Water
- Wastewater
- Reclaimed

- Location:  Paved Area  
 Grassed Area

- Cover at Finish Grade:  Cover at finish grade  
 Cover above/below finish grade-adjust per spec.

- Locate wire accessible in box:  Yes  
 No, full of debris – excavate debris

- Locate wire properly color coded:  Yes  
 No—replace per spec

- Locate wire signal verified:  Yes  
 No—repair per spec

Comments:

Contractor Representative:

\_\_\_\_\_  
*Signature* *Print name*

JEA Inspector:

\_\_\_\_\_  
*Signature* *Print name*

JEA O&M representative:

\_\_\_\_\_  
*Signature* *Print name*

Commissioned this date: \_\_\_\_\_

# JEA Water and Wastewater Standards

## 501 As-Built Drawings

### V.5. JEA TRACER WIRE CERTIFICATION FORM

Project Name/Number: \_\_\_\_\_

Date(s) Tested: \_\_\_\_\_

Installed by Contractor: \_\_\_\_\_

Name of Tester: \_\_\_\_\_

Testing Company: \_\_\_\_\_

JEA Inspector: \_\_\_\_\_

Pass: \_\_\_\_\_

Fail: \_\_\_\_\_

Continuity/Signal strength between access points:

Marker Balls Installed / Located  
Color is for the utility type of Marker ball

Access pt #1 to access pt #2:					
Access pt #3 to access pt #4:			Installed		Located
Access pt #5 to access pt #6:			Installed		Located
Access pt #7 to access pt #8:			Installed		Located
Access pt #9 to access pt #10:			Installed		Located

Total footage tested	Water	Sewer / FM	Reclaimed Water	Fiber Optic

If any faults found List below (please indicate utility type and location)

Fault # 1:	
Fault # 2:	
Fault # 3:	
Fault # 4:	
Fault # 5:	

# JEA Water and Wastewater Standards

## 501 As-Built Drawings

### V.6. JEA RECORD DRAWING SUBMITTAL TRANSMITTAL

Water/ Wastewater/Reclaimed Treatment Plants, Wells and Facilities

To: W&S As-Built Submittal Mailbox \_\_\_\_\_

From: \_\_\_\_\_

Phone: \_\_\_\_\_

E-mail: \_\_\_\_\_

Company Name: \_\_\_\_\_

Date of Submittal: \_\_\_\_\_

**Signature of  
Submitter Verifying  
Compliance:** \_\_\_\_\_

Project Name: \_\_\_\_\_

Project Numbers: \_\_\_\_\_

JEA Project Manager: \_\_\_\_\_

JEA PM E-mail: \_\_\_\_\_

Engineering Firm: \_\_\_\_\_

Engineering Contact: \_\_\_\_\_

Engineers Phone: \_\_\_\_\_

Engineers E-mail: \_\_\_\_\_

Contracting Co.: \_\_\_\_\_

Contractor Contact: \_\_\_\_\_

Contractor Phone: \_\_\_\_\_

Contractor E-Mail: \_\_\_\_\_

Surveying Co.: \_\_\_\_\_

Surveyor Contact: \_\_\_\_\_

Surveyors Phone: \_\_\_\_\_

Surveyors E-mail: \_\_\_\_\_

Attached: \_\_\_\_\_ As-Built - Paper Copy & Electronic  
\_\_\_\_\_ Record Drawing Submittal Checklist filled out by Engineer, Contractor or Surveyor  
\_\_\_\_\_ Record Drawing Submittal Checklist filled out by JEA Project Manager  
\_\_\_\_\_ Equipment Attribute Worksheets completed

# *JEA Water and Wastewater Standards*

## *501 As-Built Drawings*

### V.7. JEA RECORD DRAWING SUBMITTAL REQUIREMENTS CHECK LIST

Treatment Plants

Project Name: \_\_\_\_\_

Project Numbers: \_\_\_\_\_

*Initial next to each requirement verifying compliance*

\_\_\_\_\_ On each page of record drawing, certification filled out, signed and dated by the project manager

\_\_\_\_\_ Improvements not built as per design are redrawn as constructed

\_\_\_\_\_ "RECORD DRAWING" labeled in 1" letters on each sheet

\_\_\_\_\_ Sheets are 24" x 36" in size

\_\_\_\_\_ Includes all changes by Addendum or SWA (Supplemental Work Allowance), or Change Order

\_\_\_\_\_ Includes datum & reference to state plane coordinates (Florida East Zone NAD 83, NAVD 88)

\_\_\_\_\_ Vicinity map on cover page

\_\_\_\_\_ Title page and each page includes JEA Oracle Project Number(s)

\_\_\_\_\_ Provide paper and electronic copies of Record Drawing (.dwg and .pdf formats)

\_\_\_\_\_ Street names on all streets

\_\_\_\_\_ North Arrow on each page

\_\_\_\_\_ Graphic Scale on each page

\_\_\_\_\_ JEA Capital Project number on each page

\_\_\_\_\_ JEA easements labeled as such, including RE number and Official Records Book and Page (OR #).

\_\_\_\_\_ Date of utility installation completion on each page

#### **PLANT INFRASTRUCTURE**

---

Provide and incorporate into record drawings the horizontal and vertical record locations of improvements, including the following:

\_\_\_\_\_ Corner coordinates of rectangular or square buildings, structures, and tanks.

\_\_\_\_\_ Center coordinates of circular buildings, structures, and tanks.

\_\_\_\_\_ Building floor elevations.

\_\_\_\_\_ Floor elevations of structures and tanks as required to define floor slope.

\_\_\_\_\_ Top elevations of structures and tanks and weirs.

# *JEA Water and Wastewater Standards*

## *501 As-Built Drawings*

- \_\_\_\_\_ Channel floor elevations at each change in slope.
- \_\_\_\_\_ Channel top elevations.
- \_\_\_\_\_ Manhole center coordinates for electrical duct banks, sanitary sewer, storm sewer, etc.
- \_\_\_\_\_ Pipe coordinates at changes in direction.
- \_\_\_\_\_ Coordinates of all buried valves, and fittings.
- \_\_\_\_\_ All underground piping invert or centerline elevations.
- \_\_\_\_\_ All underground pipe invert or centerline elevations at fittings.
- \_\_\_\_\_ Pipe invert, or centerline, elevations at crossing with another pipe.
- \_\_\_\_\_ Invert or top of pipe elevations and coordinates of existing pipe at crossing with new underground pipe showing Separations
  
- \_\_\_\_\_ Invert elevations of manhole pipe inlets and outlets.
- \_\_\_\_\_ Duct bank, storm sewer, sanitary sewer coordinates and elevations at changes in direction or offset measurements from existing Structures or Roadways.
  
- \_\_\_\_\_ Top and bottom elevations of duct banks at manholes and hand holes showing ID numbers
- \_\_\_\_\_ Other horizontal and vertical record data pertinent to completed Work.
- \_\_\_\_\_ Location of internal utilities and appurtenances concealed in the construction Referenced to Structure or Roadway off set dimensions
  
- \_\_\_\_\_ Details not indicated on the original contract drawings
- \_\_\_\_\_ Depths of various elements of foundations in relation to finish first floor elevations
- \_\_\_\_\_ Location, elevation, and datum of Benchmark used.
- \_\_\_\_\_ Elevation of all Pump and Housekeeping Pads
- \_\_\_\_\_ Weir Elevations
- \_\_\_\_\_ Field changes of dimensions and or details as relates to; but not limited the following:
  - Interior equipment
  - Architectural and structural changes, including relocation of doors, windows, etc.
  - Architectural schedule changes
  
- \_\_\_\_\_ Hydraulic profile sheet--update control elevations and liquid elevations for low flow, average flow, and peak hourly flow conditions including return flows (as required based on equipment selection or field changes)
  
- \_\_\_\_\_ Runs of storm sewers identified with size, material and slope (i.e., 300' of 15" RCP at S=.004)
  
- \_\_\_\_\_ Ground surface record/information shall include the following:
  - Spot elevations should be shown at a minimum 100-foot rectangular grid, sufficient to show all the important topographic features
  - All elevations shown on the construction drawings shall be confirmed or amended on the record drawing markups if finished elevations are different.

# *JEA Water and Wastewater Standards*

## *501 As-Built Drawings*

### **WELL INFRASTRUCTURE**

---

#### **WELLS**

- \_\_\_\_\_ Elevation of top casing and at grade
- \_\_\_\_\_ Depth of casing below land surface
- \_\_\_\_\_ Diameter, material and thickness of casing(s)
- \_\_\_\_\_ Depth of well below land surface
- \_\_\_\_\_ Location of well, in latitude and longitude

#### **WELLHEAD**

- \_\_\_\_\_ Wellhead pad finished elevation
- \_\_\_\_\_ All materials and sizes of lines and fittings indicated on drawings
- \_\_\_\_\_ All buried electrical conduit labeled and located
- \_\_\_\_\_ Pipe coordinates at changes in direction
- \_\_\_\_\_ Coordinates of buried valves, tees and fittings
- \_\_\_\_\_ Other horizontal and vertical record data pertinent to completed Work
- \_\_\_\_\_ Location of internal utilities and appurtenances concealed in the construction referenced to visible accessible features
- \_\_\_\_\_ Field changes of dimensions and or details
- \_\_\_\_\_ Location, elevation, and datum of Benchmark used



*Blank Page*

## **801 - MEASUREMENT AND PAYMENT**

### **I. GENERAL**

The quantities of the Contract unit price Items will be measured for payment in accordance with the provisions contained herein and verified by a representative of JEA.

### **II. SITE PREPARATION, CLEAN UP AND RESTORATION – SECTION II - 406**

No separate payment shall be made for the work covered under this section excluding installation of sodding, sprigging and seeding; and excluding removal and installation of concrete and asphalt work. Payment for the remaining work of this section shall be merged with the items for which the site preparation, clean up and restoration is required. Installation of sodding, sprigging and seeding; and removal and installation of concrete and asphalt work shall be paid as separate pay items, unless indicated otherwise in the Contract Documents or within the payment descriptions below. No payment will be made for cleanup and restoration required due to other disturbance by the Contract or beyond local industry standards for the type of work required.

### **III. DEMOLITION AND ABANDONMENT – SECTION II - 407**

#### **III.1. STRUCTURES**

##### **III.1.1. ABANDONMENT OF STRUCTURE**

Payment for abandonment of a structure, as specified, shall be at the lump sum unit price set forth in the Contract Documents and shall include all demolition; A-3 soil fill replacement for voids and unsuitable material; removal of grassing; excavating; backfilling; compacting; sealing any and all pipes leading into and out of the structure; placing and removing all traffic signs and barriers; maintaining traffic; transporting and disposal, as required, for a finished abandonment. Payment shall be made for each structure actually abandoned.

##### **III.1.2. REMOVAL OF STRUCTURE**

Payment for removal of a structure, as specified, shall be at the lump sum unit price set forth in the Contract Documents and shall include all demolition; A-3 soil fill replacement for voids and unsuitable material; removal of grassing; excavating; backfilling; compacting; sealing any and all pipes leading into and out of the structure; placing and removing all traffic signs and barriers; maintaining traffic; transporting and disposal, as required, for complete removal and disposal. Payment shall be made for each structure actually removed.

#### **III.2. PIPING**

##### **III.2.1. ABANDONMENT OF PIPING BY SEALING**

Payment for excavating and sealing ends of abandoned pipe will be at the unit price set forth in the Contract Documents for each concrete seal actually installed as indicated on the drawings or as directed by the Engineer. Payment shall be full compensation for removal of grassing; excavating; sealing; grout/mortar and brick; placing and removing all traffic signs and barriers; maintaining traffic; backfilling and compacting, as required, for a complete abandonment.

##### **III.2.2. ABANDONMENT OF PIPING BY PLUGGING**

Payment for excavating and plugging ends of abandoned pipe and associated active mains with a plugged fitting will be at the unit price set forth in the Contract Documents for each plug actually

# ***JEA Water and Wastewater Standards***

## ***801 Measurement and Payment***

installed as indicated on the drawings or as directed by the Engineer. Payment shall be full compensation for removal of grassing; excavating; plugging; placing and removing all traffic signs and barriers; maintaining traffic, backfilling and compacting, as required, for a complete abandonment. The cost associated with valve box and cover abandonment (for grass areas – removal and disposal of box, cover and A-3 soil backfill of the box void areas; removal and disposal of any large (over 300 gallons) volume of sewage in wastewaters or force mains, for paved areas – removal and disposal of cover and grout filling valve box) will not be paid for separately but shall be included in the cost of the associated main to be abandoned.

### **III.2.3. ABANDONMENT OF PIPING BY GROUT FILLING**

Payment for excavating and grout filling abandoned mains shall be at the per linear foot unit price as set forth in the Contract Documents. Payment for grout filling wastewater laterals shall be included in the per foot price of grout filling gravity wastewater main. Payment will be compensation in full for removal of grassing; excavating as required; grout; grout filling; backfilling and compacting; placing and removing all traffic signs and barriers; maintaining traffic; as required, for a complete abandonment. The cost associated with valve box and cover abandonment (for grass areas – removal, and disposal of box, cover and A-3 soil backfill of the box void areas; removal and disposal of any large (over 300 gallons) volume of sewage in wastewaters or force mains, for paved areas – removal and disposal of cover and grout filling valve box) will not be paid for separately but shall be included in the cost of the associated main to be abandoned.

### **III.2.4. REMOVING PIPE BELOW GRADE**

Payment for removing pipe (including asbestos pipe) below grade shall be at the linear foot unit price, as set forth in the Contract Documents for each linear foot of pipe actually removed. Payment will be compensation in full for removal of grassing; excavating; removal of piping; transporting and disposal of the pipe and appurtenances; (including asbestos pipe if noted on the drawings), placing and removing all traffic signs and barriers; maintaining traffic, A-3 soil fill replacement; backfill and compacting as required.

### **III.2.5. REMOVING PIPE ABOVE GRADE**

Payment for removing pipe (including asbestos pipe) above grade shall be at the linear foot unit price as set forth in the Contract Documents for each linear foot of pipe actually removed. Payment will be compensation in full for excavating as required; removal of piping; transporting and disposal of pipe and appurtenances; placing and removing all traffic signs and barriers, maintaining traffic; backfilling and compacting.

### **III.3. REMOVAL OF EQUIPMENT**

Payment for removal of equipment shall be the lump sum unit price as established in the Contract Documents and shall include complete removal, transporting and disposal of the equipment as directed by the Engineer.

### **III.4. EXCAVATION AND EARTHWORK – SECTION II - 408**

III.4.1. Except as noted, no payment will be made for the work specified in Chapter II.3. - Section 408 (excluding non-native fill) above the proposed pipe invert or structure outside bottom. The cost thereof is included in the unit or lump sum price set forth in the contract for the items to which the excavation and backfill is incidental or appurtenant.

# *JEA Water and Wastewater Standards*

## *801 Measurement and Payment*

- III.4.2. Granular material, when authorized for use as backfill or bedding material, used at the Contractor's convenience instead of A-3 soil, shall be paid for at the unit price set forth in the Contract for AASHTO Class A-3 soil. Granular material used shall be measured in cubic yards, compacted in place, and as specified hereinafter.
- III.4.3. Granular material used to backfill unauthorized excavation or for any temporary drainage proposed shall not be measured for payment.
- III.4.4. The unit price per cubic yard as set forth in the Contract for AASHTO Class A-3 soil used as backfill shall constitute full compensation for removal from the job site and disposal of all unsuitable material and furnishing, placing and compacting backfill as specified herein. The cost of excavation of unsuitable backfill and de-watering shall be included with the regular cost of pipe installation.
- III.4.5. The quantity of granular material and AASHTO A-3 soil (required by JEA) used for backfill (including bedding) below and/or above the normal grade measured for payment shall be the same as the number of cubic yards of unsuitable material ordered removed. Computation shall be based on applicable trench sections as specified below. Length shall be equal to the horizontal distance between vertical planes representing the average ends of the granular materials as placed in the trench, or to pay line limits of an intermediate structure as shown on the Contract Drawings or as required and to a depth equal to the average depth of the unsuitable material removed. Computation shall be based on computed volume of unsuitable material ordered removed, less the volume associated with any utility mains over 12 inch diameter. Native material suitable for use as backfill shall be separated from unsuitable material and stockpiled for use on the Project. No measurement for payment will be made outside of the pay line width. Actual trench dimensions less than defined as maximum herein, shall be used when applicable. Unless approved otherwise by JEA, the quantity calculation for granular material and A-3 soil utilized for the roadway construction (sub-base, and base) shall be excluded (temporary and/or permanent use) from this pay item.
- III.4.6. For excavations 5 feet or less in depth and pipe diameters of 4-inch and greater shall be based on vertical side walls, maximum trench width of 3 feet for pipe diameters up to 12 inch. For pipe diameters larger than 12 inches, trench width shall be the pipe diameter plus 2 feet, in 6 inch increments. Trench width for pipe diameters smaller than 4-inch shall be 2 feet with vertical side walls.
- III.4.7. Excavations greater than 5 feet in depth, where no trench box or other protection is used, shall be based on trench bottom width equal to the pipe diameter plus 2 feet, in 6 inch increments, minimum width shall be 3 feet. Trench side walls shall be vertical from the trench bottom to a height of 5 feet. Remaining trench wall shall be sloped to grade 1 to 1.5, vertical to horizontal.
- III.4.8. Excavations greater than 5 feet in depth and utilizing a trench box shall have a maximum trench box width of 8 feet. Trench side walls shall be vertical from the trench bottom to a height of 5 feet, or top of trench box, whichever is greater. The remaining trench wall shall be sloped to a grade of 1 to 1.5, vertical to horizontal.
- III.4.9. When roadway replacement is indicated, unsuitable fill material replacement measurement for roadway bedding shall be made for a cross section 2 feet below the sub-grade and extending to 1 foot beyond outside edge of pavement or curbing. Applicable trench section widths, as specified herein, shall be measured below the roadway bedding.

# JEA Water and Wastewater Standards

## 801 Measurement and Payment

- III.4.10. Maximum measurement for unsuitable fill material disposal and replacement for structures shall be based on an excavation extending 3 feet from the outside wall or bottom slab projection of the structure. Unprotected excavation walls shall be vertical from the bottom of the structure to a height of 5 feet. Remaining trench wall shall be sloped to grade 1 to 1.5, vertical to horizontal.
- III.4.11. No measurement or payment shall be made for steel sheeting driven and pulled, or cut off and left in place (for contractor's convenience) to all depths. The cost shall be merged with the cost of the items to which the sheeting is incidental or appurtenant.
- III.4.12. The cost of trench boxes shall be merged with the cost of the items to which the boxes are incidental or appurtenant.

### III.5. FLOWABLE FILL

Flowable fill in accordance with FDOT Index 307 shall be used as backfill as noted on the drawings or in accordance to FDOT permit conditions, and shall be paid for at the unit price allowed in the bid form for flowable fill. Flowable fill shall be measured in cubic yards. Flowable fill used to backfill in areas unauthorized by JEA shall not be measured for payment. The unit price per cubic yard as allowed in the bid form for flowable fill used as backfill shall constitute full compensation for removal and disposal of material from the project site, and includes furnishing and installing flowable fill, complete with temporary backfill and steel plates covering the trench. The maximum quantity of flowable fill used for backfill for utilities shall be computed based on the limits as shown on the drawings or, if no limits noted, on the trench configuration outlined in Chapter VII. - Section 801 (above), Item 4.5, less the volume associated with any utility mains.

### IV. NONFERROUS METALWORK – SECTION II - 436

No separate payment will be made for any work covered under Chapter II. 4. - Section 436, but the Contract Agreement lump sum price shall include full compensation for all labor, materials and equipment required under Chapter II. 4. - Section 436.

### V. CONCRETE WORK – SECTION II - 437

#### V.1. PIPE ENCASEMENT

Measurement of concrete used for pipe encasement shall be by the linear foot of encasement. Minimum encasement shall be at the following stated rates:

PIPE SIZE	AMOUNT OF CONCRETE PER LINEAR FOOT	CONCRETE DIMENSIONS FT X FT.
6 inch	2.3 cubic feet.	1.58' x 1.58' (1'-7")
8 inch	2.7 cubic feet.	1.75' x 1.75' (1'-9")
10 inch	3.1 cubic feet.	1.91' x 1.91' (1'-11")
12 inch	3.5 cubic feet.	2.07' x 2.07' (2'-1")
14 inch	3.9 cubic feet.	2.23' x 2.23' (2'-3")
15 inch	4.4 cubic feet.	2.37' x 2.37' (2'-4")
18 inch	5.0 cubic feet.	2.60' x 2.60' (2'-7")
21 inch	6.1 cubic feet.	2.92' x 2.92' (2'-11")
24 inch	7.5 cubic feet.	3.26' x 3.26' (3'-3")
36 inch	10.6 cubic feet.	4.20' x 4.20' (4'-2")
42 inch	12.6 cubic feet.	4.71' x 4.71' (4'-9")

# *JEA Water and Wastewater Standards*

## *801 Measurement and Payment*

Payment for pipe encasement shall be at the unit price stated in the contract. The unit price shall constitute full compensation for furnishing and placing the concrete, forming, vibrating and placing and removing all traffic signs and barriers, and maintaining traffic.

### **V.2. OTHER CONCRETE**

Payment for other concrete shall be included in the Contract Price for the item in which it is used such as drop connections and service connections. Payment for concrete driveways, sidewalks and curbs shall be as outlined in Chapter II. 9. - Section 491 - Sidewalk, Driveway and Curbing.

### **VI. GENERAL EQUIPMENT REQUIREMENTS – SECTION II - 439**

No additional compensation shall be provided for the items specified in Section 439. Payment shall be included with the item to which Chapter IV. 3. - Section 439 applies.

### **VII. GRASSING – SECTION II - 441**

The unit price per square yard as set forth in the Contract for sodding, sprigging or seeding and mulching shall constitute full compensation for furnishing and installing, fertilizing and maintaining, the sodding, sprigging or seeding and mulching. If a planted area must be replanted due to the Contractor's negligence, excessive amount of damage for type of construction, or failure to provide routine maintenance of the area, such replacement shall be at the Contractor's expense.

### **VIII.PAVING – SECTION II - 490**

#### **VIII.1. SIGNAGE**

Costs incurred by the Contract or to provide new signage (where noted on the plans) and replacement of pavement markers, and removal and replacement of existing signage as noted on the plans shall not be paid for separately but shall be merged with the cost of furnishing and installing new road construction. Signage damaged by the Contractor shall be replaced at the Contractor's expense. All signage and pavement markers shall be in accordance with the drawings and City Traffic Engineer's requirements.

#### **VIII.2. COJ JOINT PROJECTS**

Measurement and payment for projects with paving for dedication to the City of Jacksonville not under contract with JEA shall be in accordance with the City of Jacksonville Standard Specifications and Details. Measurement and payment for projects with paving to be paid for under contract with JEA shall be as follows: (See Standards Manual for continuation).

#### **VIII.3. REMOVAL OF PAVING**

Payment for the removal of paving shall be at the square yard unit price set forth in the Contract Documents for complete removal and disposal of paving including placing and removing all traffic signs and barriers and maintaining traffic. Payment for paving removal shall be the actual square yards of paving removed with a maximum corresponding to the pay line trench widths in Chapter II. 3. - Section 408 – Excavation and Earthwork.

#### **VIII.4. PAVING REPAIR - CROSS CUTS AND PATCHES**

Cross cuts and patches shall be measured and paid in two separate pay items. The first pay item shall include the sub-base, base course and asphalt for the roadway repair and shall be measured in square yards with a maximum being the trench width described in Chapter II. 3. - Section 408 - Excavation and Earthwork as detailed in the applicable City of Jacksonville Standard Case Detail. Payment shall be for the actual square yards of sub-base/base course/asphalt combination installed and shall include the

# *JEA Water and Wastewater Standards*

## *801 Measurement and Payment*

construction of new or reworked sub-base, new or reworked base course and new asphalt including placing and removing all traffic signs and barriers and maintaining traffic; cleaning up the site; temporary striping and furnishing all labor, material and equipment. The asphalt overlay shall be a separate pay item measured in square yards and payment shall be full compensation for the asphalt overlay including striping; placing and removing all traffic signs and barriers; maintaining traffic; cleaning up the site and furnishing all labor, material and equipment. Required thickness of sub-grade, base and asphalt and extent of overlay required shall be as detailed or called for on the Contract Documents or drawings.

### **VIII.5. PAVING REPLACEMENT - NEW ROAD CONSTRUCTION**

Payment for entire roadway replacement shall be broken into 3 parts. Payment shall be made for the actual square yards of sub-base and the actual square yards of base course installed and shall be full compensation for preparation and installation of the new or reworked stabilized sub-base or base course including excavation; placing and removing all traffic signs and barriers and maintaining traffic; cleaning up the site and furnishing all labor, material and equipment. Payment shall be made for the actual square yards of asphalt installed and shall be full compensation for the asphalt paving installed complete including striping; placing and removing all traffic signs and barriers and maintaining traffic; cleaning up the site and furnishing all labor, material and equipment. Required thickness of sub-grade, base and asphalt shall be as detailed or called for on the contract documents or drawings.

### **VIII.6. PAVING REPLACEMENT – NEW ROAD CONSTRUCTION INCLUDING REGRADING SWALES**

Payment for entire roadway replacement shall be broken into 3 parts. Payment shall be made for the actual square yards of sub-base and the actual square yards of base course installed and shall be full compensation for preparation and installation of the new or reworked stabilized sub-base or base course including excavation; placing and removing all traffic signs and barriers and maintaining traffic; cleaning up the site and furnishing all labor, material and equipment. All existing swales/ditches shall be regraded to match (new and existing) storm pipe inverts. No separate payment shall be made for regrading and disposing of debris, but shall be included in the unit price for sub-base construction. Payment shall be made for the actual square yards of asphalt installed and shall be full compensation for the asphalt paving installed complete including striping; placing and removing all traffic signs and barriers and maintaining traffic; cleaning up the site and furnishing all labor, material and equipment. Required thickness of sub-grade, base and asphalt shall be as detailed or called for on the contract documents or drawings.

### **VIII.7. EXISTING PAVEMENT – ASPHALT OVERLAY**

Measurement shall be made for the actual square yards of asphalt overlay installed (minimum of 1 inch final overlay thickness). Payment shall be made for the actual square yards of asphalt installed and shall be full compensation for the asphalt paving installed complete including all temporary and permanent pavement markings; placing and removing all traffic signs and barriers; maintenance of traffic (MOT); cleaning up the site and furnish all labor, material and equipment. Required thickness of asphalt shall be 1-inch final overlay thickness (minimum) unless noted otherwise on the contract documents or drawings.

### **VIII.8. EXISTING PAVEMENT – MILLING AND RESURFACING**

Milling and resurfacing of asphalt surfaces shall be performed with prior approval of JEA, and in accordance with the JEA Standards or the Florida Department of Transportation Standard Specifications and Details. Measurement shall be the amount of square yards to be milled and resurfaced within the limits shown on the drawings. Payment shall be for the actual number of square yards of asphalt surface that is milled and replaced with new asphalt mix (1-inch minimum thickness) including all temporary and permanent pavement

# *JEA Water and Wastewater Standards*

## *801 Measurement and Payment*

markings (MOT), markers, signing, delineators, buttons, stripe, placing and removing all traffic signs and barriers, maintenance of traffic, clean up at the site and furnishing all labor, material and equipment.

### **VIII.9. TRAFFIC LOOPS**

Traffic loops shall be paid per loop. Payment shall be for the actual number of loops, including leaders as far back as necessary, installed, including furnishing and installing all labor materials, tools, and equipment plus all incidental work required to complete the item.

## **IX. SIDEWALK, DRIVEWAY, CURB AND GUTTER – SECTION II - 491**

### **IX.1. REMOVAL OF SIDEWALK**

Payment for the removal of sidewalk shall be at the square yard unit price set forth in the Contract Documents and shall include and be full compensation for complete removal and disposal of sidewalk, including handicap ramps, placing and removing all traffic signs and barriers and maintaining traffic. Payment for sidewalk removal shall be the actual square yards of sidewalk removed with a maximum corresponding to the pay line trench widths in Chapter II. 3. - Section 408 – Excavation and Earthwork, or to nearest construction joint unless indicated otherwise.

### **IX.2. REMOVAL OF DRIVEWAY**

Payment for the removal of driveway shall be at the square yard unit price set forth in the Contract Documents for either asphalt or concrete driveway removal. Payment shall include and be full compensation for complete removal and disposal of driveway including placing and removing all traffic signs and barriers and maintaining traffic. Payment for driveway removal shall be the actual square yards of driveway removed with a maximum corresponding to the pay line trench widths in Chapter II. 3. - Section 408 – Excavation and Earthwork, or to nearest construction joint unless indicated otherwise.

### **IX.3. REMOVAL OF CURB AND GUTTER**

Payment for the removal of curb and gutter shall be at the linear foot unit price set forth in the Contract Documents and shall include and be full compensation for complete removal and disposal of curb and gutter including placing and removing all traffic signs and barriers and maintaining traffic. Payment for curb and gutter removal shall be the actual linear feet of curb and gutter removed with a maximum corresponding to the pay line trench widths in Chapter II. 3. - Section 408 – Excavation and Earthwork, or to nearest construction joint unless indicated otherwise.

### **IX.4. INSTALLATION OF SIDEWALK**

Payment for the installation of sidewalk (including handicap ramps) shall be at the square yard unit price set forth in the Contract Documents and shall include preparation and construction of new sidewalk including forming and vibrating (if required), placing and removing all traffic signs and barriers and maintaining traffic. Payment for the sidewalk shall be the actual square yards of sidewalk installed with a maximum corresponding to the pay line trench widths in Chapter II. 3. - Section 408 – Excavation and Earthwork, or to nearest construction joint unless indicated otherwise. Sidewalk installation shall include handicap ramps. No separate pay item for construction of handicap ramps. No payment shall be made for sidewalk through concrete driveways.

### **IX.5. INSTALLATION OF DRIVEWAYS**

Payment for the installation of driveways shall be at the square yard unit price set forth in the contract documents for the type of driveway to be installed. If directed by JEA, the contractor shall furnish and install a concrete apron for all existing dirt and aggregate driveways. Payment shall include preparation and



# *JEA Water and Wastewater Standards*

## *801 Measurement and Payment*

construction of driveway including forming and vibrating (if required), placing and removing all traffic signs and barriers and maintaining traffic. Payment for driveway shall be the actual square yards of each type of driveway installed with a maximum corresponding to the pay line trench widths in Chapter II. 3. - Section 408 – Excavation and Earthwork, or to nearest construction joint unless indicated otherwise or as directed by JEA.

### **IX.6. INSTALLATION OF CURB AND GUTTER**

Payment for the installation of curb and gutter shall be at the linear foot unit price set forth in the contract documents for the type of curb and gutter to be installed. Payment shall include preparation and construction of curb and gutter including forming and vibrating (if required), placing and removing all traffic signs and barriers and maintaining traffic. Payment for curb and gutter shall be the actual linear feet of each type of curb and gutter installed with a maximum corresponding to the pay line trench widths in Chapter II. 3. - Section 408 – Excavation and Earthwork, or to nearest construction joint unless indicated otherwise.

### **X. FENCING – CHAPTER II. 10. - SECTION 492**

Measurement and payment for projects with fencing for dedication to the City of Jacksonville, not under contract with the JEA, shall be in accordance with the City of Jacksonville Standard Specifications and Details. Measurement and payment for projects with fencing to be paid for under contract with the JEA shall be as follows: Payment shall include removal and disposal of existing fencing system (if applicable); the furnishing, preparation and installation of new fence and gates as required in the Contract Documents. Payment for fencing shall be the actual linear feet of each size and type of fencing installed as indicated on the Contract Documents. Payments for gates shall be at the unit price for each size and type actually installed as indicated on the Contract Documents.

### **XI. DRAINAGE – CHAPTER II. 11. - SECTION 493**

Measurement and payment for projects with drainage improvements for dedication to the City of Jacksonville, not under contract with the JEA, shall be in accordance with the City of Jacksonville Standard Specifications and Details. Measurement and payment for projects with drainage to be paid for under contract with the JEA shall be as follows:

#### **XI.1. INSTALLATION OF DRAINAGE PIPE**

The quantity to be paid for will be the length in linear feet of each size of drainage pipe actually laid. Measurement for drainage pipe installed shall be the actual length of pipe installed, excluding pipe in structures, measured along the horizontal projection of the center line of pipe. Payment for the work will be at the Contract unit price and shall be full compensation for the item of work completed including; removal of grassing; silt fence; excavation; de-watering; native soil backfilling; laying pipe; installing filter fabric at joints; furnishing and placing steel decking over excavations; all sheeting, shoring and bracing required to maintain excavations in a safe condition; protecting existing structures, utilities and property both public and private; placing and removing all traffic signs and barriers and maintaining traffic; installing silt fence and other erosion, sedimentation protection and control devices; cleaning up the site; furnishing all material, labor, tools, and equipment and all incidental and related work required to complete the work of the item unless indicated otherwise on the Contract Documents. Payment for extra base material (lime rock) required in accordance with City of Jacksonville Standard Plate-804 will not be paid for separately, but will be merged with the costs of associated drainage pipe to be provided. No separate payment shall be made for standard connection to existing drainage pipe/structure, but shall be considered incidental and all costs for connecting to existing drainage pipe structure shall be merged with the associated line item on the Bid Form.

#### **XI.2. INSTALLATION OF STRUCTURES**

# *JEA Water and Wastewater Standards*

## *801 Measurement and Payment*

The quantity to be paid for will be the number of drainage structures actually installed. Payment for the work will be at the Contract unit price shown for each respective item and shall be full compensation for the item of work completed, including removal of grassing; excavation; de-watering; native soil backfilling; installing structure; furnishing and placing steel decking over excavations; all sheeting, shoring and bracing required to maintain excavations in a safe condition; protecting existing structures, utilities and property both public and private; placing and removing all traffic signs and barriers, and maintaining traffic; cleaning up the site; furnishing all material, labor, tools and equipment and all incidental and related work required to complete the work of the item unless indicated otherwise on the Contract Documents.

### **XI.3. INSTALLATION OF UNDERDRAIN TRENCH**

Furnishing and installing underdrain: The quantity to be paid for will be the actual linear feet of underdrain trench installed. Measurement shall be made along the horizontal projection of the centerline of pipe. Payment for the work will be at the Contract unit price and shall be full compensation for the item of work completed; including removal of grassing; excavation; de-watering; native soil backfilling; furnishing and installing pipe, filter material (rock and filter fabric), filter media, including all necessary fittings; furnishing and placing steel decking over excavations; all sheeting, shoring and bracing required to maintain excavation in a safe condition; protecting existing structures, utilities and property both public and private; placing and removing all traffic signs and barriers and maintaining traffic (MOT); cleaning up the site; furnishing all material, labor, tools, and equipment and all incidental and related work required to complete the work of the item unless indicated otherwise on the Contract Documents.

### **XI.4. INSTALLATION OF UNDERDRAIN TRENCH CLEANOUT**

Furnishing and installing underdrain cleanout: The quantity to be paid for will be the actual number of cleanouts installed. Measurement shall be made for each cleanout. Payment for the work will be at the Contract unit price and shall be full compensation for the item of work completed; including removal of grassing; excavation; de-watering; native soil backfilling; furnishing and installing cleanout; connection to underdrain piping including all necessary fittings; furnishing and placing steel decking over excavations; all sheeting, shoring and bracing required to maintain excavation in a safe condition; protecting existing structures, utilities and property both public and private; placing and removing all traffic signs and barriers and maintaining traffic; cleaning up the site; furnishing all material, labor, tools, and equipment and all incidental and related work required to complete the work of the item unless indicated otherwise on the Contract documents.

## **XII. POTABLE WATER PIPING – SECTION III - 350**

### **XII.1. FURNISHING AND INSTALLING PIPELINE**

The quantity to be paid for will be the actual number of linear feet of each size, class and type of pipe actually installed. Measurement shall be made along the horizontal projection of the center line of pipe. No deduction in length will be made for the space occupied by valves or fittings. Payment for the work will be at the Contract unit price shown for each respective item and shall be full compensation for the item of work completed, including all required removal of grassing; silt fence, excavation; de-watering; native soil backfilling; laying and jointing pipe; pressure and leakage testing; swabbing, flushing and disinfecting; de-chlorination (if required); furnishing and placing steel decking over excavations; all sheeting, shoring, and bracing required to maintain excavations in a safe condition; protecting existing structures, utilities and property both public and private; placing and removing all traffic signs and barriers and maintaining traffic; cleaning up the site; installing silt fence and other erosion, sedimentation protection and control devices; furnishing and installing locate wiring, locate wire test stations, locate wire-related appurtenances and locate wire testing; furnishing all material, labor, tools, and equipment; as-builts; and all incidental and related work required to complete the work of the item. No additional payment shall be made for vertical deflection of the

# *JEA Water and Wastewater Standards*

## *801 Measurement and Payment*

proposed pipeline to accommodate the vertical installation (minimum required cover) of the gate valves, but all costs shall be merged with the associated line item in the Bid Form. Cost incurred by the Contractor to provide 2 inch fittings associated with the pipe work shall not be paid for separately, but shall be included in the cost of furnishing and installing the 2 inch water main. Should JEA elect the swabbing of mains sized 12 and smaller, the work shall be performed by the Contractor via a Supplemental Work Authorization. No separate payment shall be made for swabbing of mains larger than 12 inches diameter.

### **XII.2. FURNISHING AND INSTALLING FITTINGS**

The quantity to be paid for will be the actual number of fittings furnished and installed. Payment for the work will be made at the Contract unit price and shall be full compensation for the items of work including furnishing and installing fittings and mechanical restraints at fitting joints, complete with all necessary incidental work required to complete the work and all materials, labor, tools and equipment.

### **XII.3. FURNISHING AND INSTALLING CASING**

The quantity to be paid for will be the actual number of linear feet of each size casing and method of installation actually installed. Measurement shall be made along the horizontal projection of the center line of the casing. Payment for the work will be made at the Contract unit price and shall be full compensation for the items of work, complete, including casing pipe; casing spacers; pipe joint restraints and total restraining system required on the carrier pipe (water main); locate wiring; excavation; de-watering; placing and removing all traffic signs and barriers and maintaining traffic; as-builts; and all incidental work required to complete the work including all materials, labor, tools and equipment.

### **XII.4. FURNISHING AND INSTALLING POLYETHYLENE WRAP**

The quantity to be paid for will be in linear feet of polyethylene wrap actually installed. Measurement shall be made along the horizontal projection of the center line of the pipe being wrapped including fittings and valves. Payment for the work will be made at the Contract unit price and shall be full compensation for the items of work, complete, including all incidental work required to complete the work and all materials, labor, tools and equipment.

### **XII.5. FURNISHING AND INSTALLING PIPE SUPPORTS**

The quantity to be paid for will be the actual number of supports furnished and installed. Payment for the work will be made at the Contract unit price and shall be full compensation for the items of work, complete, including furnishing and installing supports and all incidental work required to complete the work and all materials, labor, tools and equipment.

### **XII.6. FURNISHING AND INSTALLING PIPE BELL RESTRAINT**

The quantity to be paid for will be the actual number of bell restraints or joint restraint gaskets (or JEA approved restraint device from pipe manufacturer) installed with the maximum required to be installed as indicated in the counted in full 20 foot segments extending from the fitting or for carrier piping bell restraints as required. Payment for the work shall be made at the Contract unit price and shall be full compensation for the items of work including furnishing and installing the bell restraint, complete or joint restraint, with all necessary incidental work required, including all materials, labor and equipment. No payment will be made for thrust restraints used for the Contractor's convenience in addition to the bell restraints called for in the Restraint Joint Schedule.

### **XII.7. SPLIT RING PIPE BELL RESTRAINTS - (EXISTING MAINS)**

The quantity to be paid for will be the actual number of each size split ring pipe bell restraints required to be installed, in accordance with Restraint Joint Schedules, Plate W-31A (PVC pipe) and W-31B (DIP pipe),

# *JEA Water and Wastewater Standards*

## *801 Measurement and Payment*

as applicable. Payment for the work will be made at the Contract unit price and shall be full compensation for the items of work including furnishing and installing the split ring pipe bell restraints at locations along the existing mains; all required removal of grassing; excavation; de-watering; native soil backfilling; locating the existing pipe bells, etc.; furnishing and placing steel decking over excavations; all sheeting, shoring, and bracing required to maintain excavations in a safe condition; protecting existing structures, utilities and property both public and private; placing and removing all traffic signs and barriers and maintaining traffic; cleaning up the site; furnishing all material, labor, tools, and equipment; as-builts; and all incidental and related work required to complete the work of the item with all necessary incidental work required, including all materials, labor and equipment. No payment will be made for thrust restraints used for the Contractor's convenience in addition to the bell restraints called for in the Restraint Joint Schedule.

### **XII.8. FURNISHING AND INSTALLING THRUST COLLAR**

If thrust collar (dead man) is used instead of bell restraints or tie rods to length indicated on the restraint joint schedule on dead end lines, payment shall be for each thrust collar installed (by size of pipe).

### **XII.9. FURNISHING AND INSTALLING NEW WATER SERVICES**

The quantity to be paid will be the actual number of services connections installed as detailed on Plate W-1, W-2 and W-5. Payment for the work will be made at the contract unit price for each size of long or short side service type and shall be full compensation for the items of work including furnishing and installing the service piping; connection to water main and plugging to new service termination in meter box; corporation stop (standard or HDPE type); curb stop; locate wiring; boring (if required); flushing and disinfection; all required removal of grassing; excavation; de-watering; native soil backfill; furnishing and placing a steel decking over excavations; all sheeting, shoring, and bracing required to maintain excavations in a safe condition; protecting existing structures, utilities and property both public and private; placing and removing all traffic signs and barriers and maintaining traffic; as-builts; cleaning up the site; installing silt fence and other erosion, sedimentation protection and control devices; furnishing all material, labor, tools and equipment and all incidental and related work to complete the item. Payment for a "double 1-inch water service" shall include 2-inch connections to main, 2-inch poly pipe, Y-fitting, 1-inch poly to meter boxes, two curb stops, other items as listed above to complete the water service installation to two customers (excluding meter boxes). Payment for a "Gang water service for 3 services" and a "Gang water service for 4 services" shall be based upon a unit price each and include 2" saddle, 2" poly tubing, multi-Y with pack joint couplings, 1" poly line to all associated meter boxes, all curb stops and other items as listed above to complete the water service installation to 3 or 4 customers (excluding meter boxes).

### **XII.10. REPLACEMENT/RELOCATION RESIDENTIAL WATER SERVICES**

The quantity to be paid for will be the actual number of each size service replaced. Payment for the work will be made at the Contract unit price for each size of long, short type or double 1-inch service (including poly pipe to two meter boxes and associated curb stops and shall be full compensation for the items of work including furnishing and installing service piping; connection to water main; relocating existing meter and meter box at the right-of way (as detailed on Plate W-1); connection to existing private house service piping; corporation stop (standard or HDPE type), curb stop, and service fittings; meter couplings; removal of old service piping (if applicable); cutting and threading existing pipe; all necessary jointing; removing, adjusting and resetting existing meter and meter boxes; all required removal of grassing; excavation; de-watering; native soil backfill; furnishing and placing steel decking over excavations; all sheeting, shoring, and bracing required to maintain excavations in a safe condition; locate wiring; boring (if required); flushing and disinfection, protecting existing structures, utilities and property both public and private; placing and removing all traffic signs and barriers and maintaining traffic; as-builts; cleaning up the site; installing silt fence and other erosion, sedimentation protection and control devices; furnishing all material, labor, tools and equipment; and all incidental and related work to complete the item.

# *JEA Water and Wastewater Standards*

## *801 Measurement and Payment*

### **XII.11. EXISTING RESIDENTIAL WATER METER ASSEMBLY ADJUSTMENT (RAISE)**

Where the existing grade elevation at the water meter assembly is being raised, the Contractor shall adjust the existing water meter assembly by installing a meter adjustment – resetter. The resetter shall not exceed 12 inches in height; existing service shall not exceed 24 inches in depth from finish grade. Resetters shall not be placed in concrete or drive ways. The quantity to be paid for will be the actual number of water meter assemblies adjusted. Payment for the work will be made at the contract unit price for each size of water meter assembly adjusted and shall be full compensation for the items of work including furnishing and installing meter adjustment – resetter (height as required not to exceed 12 inches); and miscellaneous service connection fittings/gaskets; all necessary jointing; removing, adjusting and resetting existing meter boxes; all required removal of grassing; excavation; de-watering; native soil backfill; furnishing and placing steel decking over excavations; all sheeting, shoring, and bracing required to maintain excavations in a safe condition; flushing, protecting existing structures, utilities and property both public and private; placing and removing all traffic signs and barriers and maintaining traffic; as-builts; cleaning up the site; installing silt fence and other erosion, sedimentation protection and control devices; furnishing all material, labor, tools and equipment; and all incidental and related work to complete the item.

### **XII.12. LINE STOP**

The quantity to be paid will be the actual number of each size line stop actually installed. Payment for the work will be made at the contract unit price and shall be full compensation for the items of work including, but not limited to plugging of the existing main utilizing the “line stop” method; furnish and install fabricated steel line stop fittings; epoxy coated, w/304 SS nuts and bolts; closure completion plugs (sized as required, or an approved equal); 150# blind flange (sized as required) w/304 SS nuts and bolts; 2” equalization/purge fittings; subsequent removal and disposal of line stop; excavation; removal/disposal and subsequent replacement of pavement; concrete work (support for line stop fittings); concrete thrust collar; restrained joint plug and tie rods as required; lifting and rigging equipment; all required removal of grassing; excavation; de-watering; native soil backfill; furnishing and placing steel decking over excavations; all sheeting, shoring, and bracing required to maintain excavations in a safe condition; flushing, protecting existing structures, utilities and property both public and private; placing and removing all traffic signs and barriers and maintaining traffic; as-builts; cleaning up the site; installing silt fence and other erosion, sedimentation protection and control devices; furnishing all material, labor, tools and equipment; and all incidental and related work to complete the item.

### **XII.13. COMPLIANCE SAMPLE TAPS (JEA PLATE W-27)**

The quantity to be paid will be the actual number of each compliance sample tap installed and removed in accordance with JEA Water and Wastewater Standards Plate No. W-27. Payment for a temporary sample tap will be made at the contract unit price and shall be full compensation for the item of work including all necessary removal of grassing, and excavation around existing water meter and box assembly; relocation, reconnection, and replacement of meter and meter box; furnishing and installing all necessary piping, fittings, meter resetter, smooth hose/tubing, valve, native backfill material, and sodding; protecting existing structures, utilities and property both public and private; placing and removing traffic barricade; assisting with outage simulations, preparation and distribution of customer notifications and/or boil water notices; cleaning up the site; installing silt fence and other erosion, sedimentation protection and control devices; furnishing all material, labor, tools, and equipment and all incidental and related work required to complete the work of the item unless indicated otherwise on the contract documents.

### **XII.14. TEMPORARY SAMPLE TAPS**

The quantity to be paid will be the actual number of each size and type of sample tap installed and removed. A sample tap utilizing alternative methods (type) will include a sample tap utilizing a new 1-inch water

# *JEA Water and Wastewater Standards*

## *801 Measurement and Payment*

service or a plug at flushing location (see W-24 and W-24A details). There shall be no payment made for temporary sample taps utilizing alternative methods unless this item is specifically listed on the bid form. The cost of a temporary sample tap utilizing alternative methods shall be included in the unit price of the piping. Payment for a temporary sample tap as shown on Detail W-25 or W-26 will be made at the contract unit price and shall be full compensation for the item of work including furnishing and installing, complete, all necessary piping; service saddle; corporation stop; plug; bushings; bends; tees; smooth hose, hose bib; gate valve, furnishing all material, labor, tools and equipment and all incidental and related work required to complete the item.

### **XIII. WATER VALVES AND APPURTENANCES – SECTION III - 351**

#### **XIII.1. FURNISHING AND INSTALLING FIRE HYDRANTS**

The quantity to be paid will be the actual number of units furnished and installed. Payment for the work will be made at the contract unit price and shall be full compensation for the item of work, complete, including all required excavation and backfill; silt fence, placing and removing all traffic signs and barriers and maintaining traffic; furnishing and installing the hydrant (regardless of "bury depth") and hydrant extension (if required); restraint rods; blue pavement reflector; all nuts, bolts, glands, and socket clamps; construction of the hydrant sump including selected stone fill; rod restraints; furnishing all material; labor, tools and equipment; performing hydrostatic and leakage testing; and all incidental and related work required to complete the item. Separate payment will be made for hydrant lateral pipe, fittings, and valves.

#### **XIII.2. FIRE HYDRANT RELOCATION**

The quantity to be paid will be the actual number of existing fire hydrants removed and re-installed. Payment for the work will be made at the contract unit price and shall be full compensation for the item of work, complete, including all required excavation and backfill; placing and removing all traffic signs and barriers and maintaining traffic; removal, storage, and subsequent re-installation of existing fire hydrant; furnishing and installing the hydrant riser adjustment/extension as required to achieve proper bury depth; furnishing and installing new paint of the existing fire hydrant and above ground piping; re-oil and re-grease the fire hydrant; furnishing and placing all necessary hydrant sump work as indicated on the standard hydrant detail at fire hydrant; all nuts, bolts, glands, and socket clamps; furnishing all material, labor, tools and equipment; performing hydrostatic and leakage testing; all sheeting, shoring, and bracing required to maintain excavations in a safe condition; protecting existing structures, utilities and property both public and private; placing and removing all traffic signs and barriers and maintaining traffic; cleaning up the site; installing silt fence and other erosion, sedimentation protection and control devices; furnishing all material, labor, tools, and equipment; as-builts; and all incidental and related work required to complete the work of the item with all necessary incidental work required, including all materials, labor and equipment. Separate payment will not be made for new coat of paint for fire hydrants. All work shall be in accordance with JEA Water Construction Details W-12 thru 19, inclusive.

#### **XIII.3. FURNISHING AND INSTALLING VALVES**

The quantity to be paid will be the actual number of units of each size and type furnished and installed. Payment for the work will be made at the contract unit price and shall be full compensation for the item of work including furnishing and installing the valve, complete, with all required excavation and backfill, necessary jointing, adapter pieces, concrete supports (if applicable), mechanical restraints at valve, nuts, bolts, socket clamps, sleeves; valve box and cover, valve tags, electronic ball markers; valve box extension (if applicable); debris shield; placing and removing all traffic signs and barriers, and maintaining traffic; furnishing all material, labor, tools and equipment; flushing and disinfecting; performing hydrostatic and leakage testing; and all incidental and related work required to complete the item. For HDPE installations,

# *JEA Water and Wastewater Standards*

## *801 Measurement and Payment*

payment shall also include mechanical or flange connection joint adapters and associated electro-fused couplings.

### **XIII.4. FURNISHING AND INSTALLING TAPPING SLEEVES AND VALVES**

The quantity to be paid for will be the actual number of units of each size furnished and installed. Payment for the work will be made at the contract unit price for each respective item and shall be full compensation for the item of work, complete, with all necessary excavation and backfill; jointing, adapter pieces, concrete supports (if applicable); tapping valves, mechanical restraints at valve; electronic ball markers; all nuts, bolts, socket clamps, sleeves; valve boxes, valve box extensions (if applicable) and valve box covers; debris shield; placing and removing all traffic signs and barriers and maintaining traffic; furnishing all material, labor, tools and equipment; flushing and disinfecting; performing hydrostatic and leakage testing and all incidental and related work required to complete the item. For HDPE installations, payment shall also include mechanical or flange connection joint adapters and associated electro-fused couplings.

### **XIII.5. FURNISHING AND INSTALLING WATER METER BOXES**

The quantity to be paid will be the actual number of units of each size furnished and installed. Payment for the work will be made at the contract unit price for each respective item and shall be full compensation for the item of work, complete, including box and PVC plug (if applicable).

### **XIII.6. FURNISHING AND INSTALLING BACKFLOW PREVENTION DEVICES**

The quantity to be paid will be the actual numbers of units furnished and installed. Payment for the work will be made at the contract unit price and shall be full compensation for the item of work including furnishing and installing the devices, complete, with all necessary jointing, bends, adapter pieces, concrete supports, tie rods, restraints, nuts, bolts, socket clamps, jackets and sleeves, isolation valves, furnishing all material, labor, tools and equipment and all incidental and related work required to complete the item.

### **XIII.7. FURNISHING AND INSTALLING VALVES OR FITTINGS IN EXISTING PIPELINES**

The quantity to be paid will be the actual number of each size valve furnished and installed. Payment for the work will be made at the contract unit price for each respective valve or fitting and shall be full compensation for the item of work, complete, including all required excavation; backfill; shutting down and dewatering the pipelines; cutting openings in the pipelines to accept the new valve or fitting and removing, stockpiling or otherwise disposing of the existing pipe section or existing valve or fitting removed; furnishing and installing the new valve or fitting; furnishing and installing all necessary pipe, couplings, sleeves, pipe adapters, concrete supports; mechanical restraints on valve or fitting; electronic ball markers; all nuts, bolts, glands, and socket clamps; furnishing and installing valve box, valve box, operating nut, and stem extension (if applicable) and valve box cover; placing and removing all traffic signs and barriers and maintaining traffic; furnishing all material, labor, tools, and equipment; flushing and disinfecting, performing hydrostatic and leakage testing, and all incidental and related work required to complete the work of the item. For HDPE installations, payment shall also include mechanical or flange connection joint adapters and associated electro-fused couplings.

### **XIII.8. VALVE BOX AND COVER ADJUSTMENT**

The quantity to be paid will be the actual number of valve box and covers when physically adjusted (vertically) to new finish grade as shown on the drawings or as required. Payment will be compensation in full for removal of grassing; excavation; dewatering; native soil backfill; furnishing and placing steel decking over excavation; adjustment of existing valve jacket, or providing new valve box jacket extension if necessary; furnish and install concrete collar; pavement repair (where applicable); placing and removing all traffic signs and barriers, and maintaining traffic; cleaning up the site; furnishing all materials, labor, tools,

# ***JEA Water and Wastewater Standards***

## ***801 Measurement and Payment***

and all incidental and related work required to complete the work of the item unless indicated otherwise on the contract documents. All adjustments shall be completed prior to the placement of the final surface. Valve box components which can be reused shall be carefully removed and the contact areas shall be cleaned of all mortar, concrete, grease and sealing compounds. Any items broken in the process of removal and cleaning shall be replaced in kind by the contract or at its own expense. If the adjustment involves slight lowering or raising a valve box, the outside shell of a slip or screw casing shall be excavated to its full length and adjusted to the proposed grade. Pipe castings shall be excavated to the depth required to cut from or weld a section to the casing as may be needed to adjust the ring to the proposed elevation. The ring shall be welded to the casing prior to pouring concrete around the casing.

### **XIII.9. FURNISHING AND INSTALLING FLUSHING VALVE**

The quantity to be paid will be the actual number of each type (above or below grade) flushing valve assembly furnished and installed. Payment for the work will be made at the contract unit price for each flushing valve assembly and shall be full compensation for the item of work, complete, including all required excavation; backfill; installing box and cover; valves; piping; bedding; flushing and disinfection; sample taps installed and removed; furnishing all material, labor, tools and equipment; and all incidental and related work to complete the item.

### **XIII.10. FURNISHING AND INSTALLING AIR RELEASE VALVES**

The quantity to be paid will be the actual number of air valve assemblies (as detailed) furnished and installed. Payment will be made at the contract unit price for each air valve assembly in manhole (or not in manhole) and shall be full compensation for the item of work, complete, including all excavation; backfill; tapping or cutting opening in pipelines; furnishing and installing air valve with all required appurtenances, manhole (if applicable) with frame and cover or aluminum door, all piping fittings and valves (gate, corp. stop, etc.) between air valve and main, saddle, sleeve or tee fitting in main, all material, labor, tools and equipment and all incidental and related work to complete the air valve assembly and associated piping between the air valve and the main.

## **XIV. SEWAGE MANHOLES – SECTION IV - 427**

### **XIV.1. FURNISH AND INSTALL SEWAGE MANHOLE**

The depth of the manhole will be measured vertically from the top of the manhole frame to the invert at the center of the manhole bottom. Payment for new sewage manholes will be in accordance with the unit price in the contract. Prices for manholes will be the installed price, complete, for the type and depth of manhole. Prices will be full compensation for furnishing and installing the manhole including all required removal of grassing; silt fence, excavation; de-watering; native soil backfilling; all sheeting, shoring and bracing required to maintain excavation in a safe condition; protecting existing structures, utilities and property; placing and removing all traffic signs and barriers and maintaining traffic; cleaning up the site; installing silt fence and other erosion, sedimentation protection and control devices; as-builts; furnishing all labor, materials, tools and equipment for manhole construction, including manhole frames, covers, inside or outside drops, connections (hole in manhole and boot or sand sleeve), and all work appurtenant thereto.

### **XIV.2. REMOVE EXISTING SEWAGE MANHOLE**

Measurement for payment of removal of existing manhole shall be the actual physical count of manholes removed as called for on the contract drawings or as approved by the Engineer. Payment for manholes removed shall be at the unit price set forth in the contract documents. Payment will be compensation in full for complete removal of the manhole and transportation and disposal of the debris; sealing any and all pipes leading in and out of the structure; excavation; backfilling; compacting; native backfill and/or ASSHTO A-3



# *JEA Water and Wastewater Standards*

## *801 Measurement and Payment*

soil fill material in the void left by removing the structure; placing and removing all traffic signs and barriers and maintaining traffic.

### **XIV.3.REMOVE AND CONSTRUCT SEWAGE MANHOLE**

Measurement for payment of "Remove and Construct Manhole" will be the depth of the new manhole measured vertically from the top of the manhole frame to the invert at the center of the manhole bottom. Payment for existing manholes removed and replaced with new manholes will be at the unit price set forth in the contract for "Remove and Construct" for the actual number of each depth manhole installed in conjunction with a manhole removal. Payment will be compensation in full for the removal of the existing manhole and disposal of the debris. Payment shall include furnishing and installing the new manhole including all required removal of grassing; excavation; de-watering; native soil backfilling; all sheeting, shoring and bracing; protecting existing structures, utilities and property; placing and removing all traffic signs and barriers and maintaining traffic; cleaning up the site; installing silt fence and other erosion, sedimentation protection and control devices; furnishing all labor, materials, tools and equipment for the construction of the new manhole complete for the type and depth, including manhole frames, covers, hole in manhole and boot or water stop, inside or outside drop connections, bypass pumping, and all work appurtenant thereto.

### **XIV.4.CONNECTION TO EXISTING SEWAGE MANHOLE**

Payment for standard connections, drop connections, service lateral connections and force main connections to existing manholes will be at the unit price set forth in the contract for the size and type of connection. The unit price will constitute compensation in full for each connection actually furnished and installed including excavation; native soil backfill; compaction; coring; piping; fittings; rubber boot or sand sleeve; grouting and repair to existing manhole wall section; placing and removing all traffic signs and barriers and maintaining traffic plus all incidental work including all labor, materials, tools and equipment.

### **XIV.5.CONSTRUCT SANITARY MANHOLE FRAME AND COVER ADJUSTMENT**

Measurement for payment of "Sanitary Manhole Frame and Cover Adjustment" (if shown on the drawings) shall be the actual count of manholes where the frame and cover was physically adjusted (vertically) to new finish grade as shown on the drawings. Where applicable, payment will be compensation in full for removal of the existing manhole frame and cover, and removal/disposal of any debris, removing/replacing all necessary grade adjustment including new manhole frame and cover (if noted) and roadway patch work (where applicable). Payment shall be at the unit price set forth in the contract documents and shall constitute full compensation for all items of work including all required removal of grassing; excavation; de-watering; native soil backfill and or A3 soil material to fill voids; furnishing and placing steel decking over excavations; all sheeting, shoring and bracing required to maintain excavations in a safe condition; protecting existing structures, utilities and property both public and private; placing and removing all traffic signs and barriers, and maintaining traffic (MOT); cleaning up the site; furnishing all material, labor, tools and equipment and all incidental and related work required to complete the work of the item unless indicated otherwise on the Contract Documents.

### **XIV.6.MANHOLE TOP ADJUSTMENT**

Measurement for payment of manhole top adjustment (including removing the existing City of Jacksonville (COJ) type manhole frames and covers and installing JEA type manhole frames and covers) shall be the actual count where the manhole tops are physically adjusted (vertically) to new finish grade at the locations shown on the drawings or as required. Payment will be compensation in full for removal of grassing; pavement; excavation; dewatering; native soil backfill; furnishing and placing steel decking over excavation; adjusting manhole top to new finish grade, removing existing COJ type manhole frame and cover; furnishing

# ***JEA Water and Wastewater Standards***

## ***801 Measurement and Payment***

and installing JEA type manhole frame and cover; grout; pavement repair (where applicable); placing and removing all traffic signs and barriers, and maintaining traffic; cleaning up the site; furnishing all materials, labor, tools, and all incidental and related work required to complete the work of the item unless indicated otherwise on the contract documents. All work shall be completed prior to the placement of the roadway base course. Existing cone sections shall be carefully removed and properly disposed. The contact areas shall be cleaned of all mortar, concrete, grease and sealing compounds. No separate payment will be made for furnishing and installing new precast cone section. COJ type manhole frames and covers shall be carefully removed and shall be cleaned of all mortar, concrete, grout and sealing compounds and shall become the property of the COJ. Such materials shall be delivered by the contract or to the Streets and Drainage Division yard. Any items broken in the process of removal, cleaning or transportation shall be replaced in kind by the contract or at its own expense

### **XV. GRAVITY WASTEWATERS – SECTION IV - 428**

#### **XV.1. WASTEWATER PIPING FURNISH AND INSTALL**

XV.1.1. Measurement of new wastewater piping for payment will be the horizontal distance between manholes with no deduction made for those spaces occupied by manholes, tees or other appurtenances. The depth of cut of wastewater piping will be measured from existing grade elevations along the center line of the pipe, taken on fifty foot stations, down to the wastewater piping invert elevation. The depth of cut will be divided into steps: first step - 2 to 4 feet, second step - 4 to 6 feet, and so on, at 2-foot intervals, unless otherwise specified in the contract documents. The method of measurement will be the same for each of the specified pipe materials.

XV.1.2. Payment for wastewater piping will be at the unit price stated in the contract for the size and class of pipe, type of material, and depth of wastewater pipe actually installed, measured as previously specified. The unit prices set forth in the contract will constitute full compensation for excavation; native soil backfilling; de-watering; sheeting and shoring driven and pulled and drag shields for trenches of all depths; silt fence, placing and removing all traffic signs and barriers and maintaining traffic; as-builts; furnishing, laying, jointing, TV work and testing the wastewater piping plus all incidental work including all labor, materials, tools and equipment. The unit price will also include stoppers for all ends of pipe and fittings, and transition couplings.

#### **XV.2. WASTEWATER PIPING – REMOVE AND REPLACE**

XV.2.1. Measurement of remove and replace wastewater piping for payment will be the horizontal distance between manholes with no deduction made for those spaces occupied by manholes, tees or other appurtenances. The depth of cut of wastewater piping will be measured from existing grade elevations along the center line of the pipe, taken on 50 foot stations, down to the wastewater pipe invert elevation. The depth of cut will be divided into steps: First step – 2 to 4 feet, second step – 4 to 6 feet, and so on, at 2-foot intervals, unless otherwise specified in the contract documents. The method of measurement will be the same for each of the specified pipe materials.

XV.2.2. Payment for wastewater piping will be at the unit price stated in the contract for the size and class of pipe, type of material, and depth of wastewater pipe actually installed, measured as previously specified. The unit prices set forth in the contract will constitute full compensation for excavation; native soil backfilling; de-watering; sheeting and shoring driven and pulled and drag shields for trenches of all depths; placing and removing all traffic signs and barriers and maintaining traffic; as-builts; furnishing, laying, jointing and testing the wastewaters; removal and disposal of the

# *JEA Water and Wastewater Standards*

## *801 Measurement and Payment*

existing wastewater pipe; stoppers for all ends of pipe and fittings; transition couplings; bypass pumping plus all incidental work including all labor, materials, tools and equipment.

### **XV.3. WASTEWATER LATERAL PIPING FURNISH AND INSTALL**

XV.3.1. Measurement of wastewater lateral pipe for payment shall be measured by the linear foot on a horizontal plane along the projection of the center line of the lateral pipe, from the center of the wastewater main to the terminal point of the lateral pipe, unless specified otherwise in the contract documents.

XV.3.2. Payment for wastewater lateral piping will be at the per linear foot price stated in the contract for the size, class and type of pipe actually installed. The unit price set forth in the contract will constitute full compensation for excavation; native soil backfilling; de-watering; sheeting and shoring driven and pulled and drag shields for trenches of all depths; placing and removing all traffic signs and barriers and maintaining traffic; as-builts; furnishing and installing the wastewater lateral piping and fittings; electronic marker (if required); stoppers for future connections plus all incidental work including all labor, materials, tools and equipment.

### **XV.4. WASTEWATER LATERAL PIPING – REMOVE AND REPLACE**

XV.4.1. Measurement of wastewater lateral pipe removal and replacement for payment shall be measured by the linear foot on a horizontal plane along the projection of the center line of the lateral pipe, from the center of the wastewater main to the terminal point of the lateral pipe, unless specified otherwise in the contract documents.

XV.4.2. Payment for wastewater lateral piping will be at the per linear foot price stated in the contract for the size, class and type of pipe actually installed. The unit price set forth in the contract will constitute full compensation for excavation and native soil backfilling; de-watering; sheeting and shoring driven and pulled and drag shields for trenches of all depths; placing and removing all traffic signs and barriers and maintaining traffic; as-builts; furnishing and installing the wastewater lateral piping and fittings; stoppers for future connections P. T. wood markers (new development projects only) and electronic marker (if required). The unit price shall also be full compensation for locating existing lateral piping; the removal and disposal of the existing wastewater lateral piping; locating existing yard piping and connecting to existing yard piping including PVC adapters plus all incidental work including all labor, materials, tools and equipment.

### **XV.5. LATERAL CONNECTIONS AT WASTEWATER MAIN**

Payment will be made for each wastewater lateral connection furnished and installed at the contract unit price for the type and size of the lateral connection actually installed as shown on the contract drawings. The unit prices set forth in the contract will constitute full compensation for excavation; native soil backfilling; de-watering; sheeting and shoring, driven and pulled; drag shields for trenches of all depths, and furnishing and installing lateral connections of all depths. Payment will consist of the cost of the tee or saddle, over and above the price paid for pipeline length measured through the tee or saddle. The unit price shall also be full compensation for locating existing lateral piping and all incidental work including all labor, materials, tools and equipment.

### **XV.6. FURNISH AND INSTALL YARD PIPING SERVICE**

Measurement of privately owned wastewater service (yard piping) shall be in linear feet measured from the right-of-way line, through private property, to the connection point of the existing yard piping as indicated

# ***JEA Water and Wastewater Standards***

## ***801 Measurement and Payment***

on the drawings. Payment for yard piping shall be full compensation for excavation; backfilling (native and Class A-3 soil); furnishing and installing piping; fittings; sleeves; adapters; landscape restoration; concrete and asphalt removal and replacement; clean outs; plugging existing yard piping; locating and connecting to existing yard piping; abandoning existing yard piping; notifying property owner and resident and obtaining a plumbing permit. Payment will be at the per linear foot unit price as set forth in the Contract measured, as previously specified.

### **XV.7. FURNISHING AND INSTALLING CASING**

The quantity to be paid for will be the actual number of linear feet of each size casing and method of installation actually installed. Measurement shall be made along the horizontal projection of the center line of the casing. Payment for the work will be made at the contract unit price and shall be full compensation for the items of work, complete, including casing pipe; casing spacers; pipe joint restraints and total restraining system required on the carrier pipe (gravity wastewater pipe); locate wiring; excavation; dewatering; placing and removing all traffic signs and barriers and maintaining traffic; as-builts; and all incidental work required to complete the work including all materials, labor, tools and equipment.

### **XV.8. FURNISHING AND INSTALLING LOW PRESSURE SERVICE CONNECTION POINT**

The quantity to be paid will be the actual number of units furnished and installed. Payment for the work will be made at the contract unit price and shall be full compensation for the item of work as detailed in Plate No. S-50 of the JEA Water and Wastewater Standards Manual, complete, including the removal of grassing; dewatering; excavation; furnishing and installing check valve, ball valves, plugs, tee, adapters, piping, locate wire; meter box with plugged lid; native soil backfill; furnishing and placing steel decking over excavations; all sheeting, shoring and bracing required to maintain excavations in a safe condition; protecting existing structures, utilities and property, both public and private; placing and removing all traffic signs and barriers and maintaining traffic; cleaning up the site; furnishing all material, labor, tools and equipment and all incidental and related work to complete the assembly. All piping outside the box shall be paid for separately under force main piping line item.

## **XVI. SEWAGE FORCE MAINS – SECTION IV - 429**

### **XVI.1. FURNISHING AND INSTALLING PIPELINE**

The quantity to be paid for will be the actual number of linear feet of each size, class and type of pipe actually installed. Measurement shall be made along the horizontal projection of the center line of pipe. No deduction in length will be made for the space occupied by valves or fittings. Payment for the work will be at the contract unit price shown for each respective item and shall be full compensation for the item of work completed, including all required removal of grassing; silt fence, excavation; de-watering; native soil backfilling; laying and jointing pipe; pressure and leakage testing; potable water (if required); flushing (if required); swabbing, furnishing and placing steel decking over excavations; all sheeting, shoring and bracing required to maintain excavations in a safe condition; protecting existing structures, utilities and property both public and private; placing and removing all traffic signs and barriers and maintaining traffic; as-builts; cleaning up the site; installing silt fence and other erosion, sedimentation protection and control devices; furnishing and installing locate wiring, locate wire test stations, locate wire-related appurtenances and locate wire testing; furnishing all material, labor, tools, and equipment and all incidental and related work required to complete the work of the item. No additional payment shall be made for vertical deflection of the proposed pipeline to accommodate the installation (minimum required cover) of the gate valves, but all costs shall be merged with the associated line item in the Bid Form. Cost incurred by the contract or to provide 2-inch fittings associated with the 2-inch pipe work shall not be paid for separately, but shall be included in the cost of furnishing and installing the 2-inch force main. Should JEA elect the swabbing of mains sized 12 and smaller, the work shall be performed by the contract or via a Supplemental Work

# *JEA Water and Wastewater Standards*

## *801 Measurement and Payment*

Authorization (SWA). No separate payment shall be made for swabbing of mains larger than 12 inches in diameter.

### **XVI.2.FURNISHING SEWAGE REMOVAL AND DISPOSAL**

JEA will reimburse the Company at cost for hiring sewage pump/tanker trucking firm(s) to perform all sewage removal and legal disposal as directed by the JEA Project Manager. Company shall clearly mark on its invoices costs associated with sewage pumping truck services identifying the cost to Company of such service. Company agrees to invoice JEA for such services at its cost with no markup.

### **XVI.3.FURNISHING AND INSTALLING FITTINGS**

The quantity to be paid for will be the actual number of fittings furnished and installed. Payment for the work will be made at the contract unit price and shall be full compensation for the items of work including furnishing and installing fittings and mechanical restraints at fitting joint, complete and in place, with all necessary incidental work required to complete the work and all materials, labor, tools and equipment.

### **XVI.4.FURNISHING AND INSTALLING CASING**

The quantity to be paid for will be the actual number of linear feet of each size casing and method of installation actually installed. Measurement shall be made along the horizontal projection of the center line of the casing. Payment for the work will be made at the contract unit price and shall be full compensation for the items of work, complete, including casing pipe; casing spacers; pipe joint restraints and total restraining system required on the carrier pipe (force main piping); locate wiring; excavation; de-watering; placing and removing all traffic signs and barriers and maintaining traffic; as-builts; and all incidental work required to complete the work including all materials, labor, tools and equipment.

### **XVI.5.FURNISHING AND INSTALLING POLYETHYLENE WRAP**

The quantity to be paid for will be in linear feet of polyethylene wrap actually installed. Measurement shall be made along the horizontal project of the center line of the pipe being wrapped including fittings and valves. Payment for the work will be made at the contract unit price and shall be full compensation for the items of work, complete, including all incidental work required to complete the work and all materials, labor, tools and equipment.

### **XVI.6.FURNISHING AND INSTALLING PIPE SUPPORTS**

The quantity to be paid for will be the actual number of supports furnished and installed. Payment for the work will be made at the contract unit price and shall be full compensation for the items of work, complete, including furnishing and installing supports, with all incidental work required to complete the work and all materials, labor, tools and equipment.

### **XVI.7.FURNISHING AND INSTALLING PIPE BELL RESTRAINT**

The quantity to be paid for will be the actual number of bell restraints or joint restraint gaskets (or JEA approved restraint device from pipe manufacturer), installed with the maximum required to be installed as indicated in the Restraint Joint Schedule counted in full 20-foot segments extending from the fitting or for carrier piping bell restraints as required. Payment for the work shall be made at the contract unit price and shall be full compensation for the items of work including furnishing and installing the bell restraint, or joint restraint, complete, with all necessary incidental work required, including all materials, labor and equipment. No payment will be made for thrust restraints used for the contract or convenience in addition to the bell restraints called for in the Restraint Joint Schedules.

### **XVI.8.FURNISHING AND INSTALLING THRUST COLLAR**

# ***JEA Water and Wastewater Standards***

## ***801 Measurement and Payment***

If thrust collar (dead man) is used instead of bell restraints or tie rods to length indicated on the Restrained Joint Schedules on dead end pipelines, payment shall be for each thrust collar installed (by size of pipe).

### **XVII. WASTEWATER VALVES AND APPURTENANCES - SECTION IV - 430**

#### **XVII.1. FURNISHING AND INSTALLING VALVES**

The quantity to be paid will be the actual number of units of each size and type valve furnished and installed. Payment for the work will be made at the contract unit price and shall be full compensation for the item of work including furnishing and installing the valve, complete, with all required excavation and backfill; silt fence, necessary jointing; adapter pieces; concrete supports (if applicable); mechanical restraints at valve; electronic ball markers; nuts, bolts, socket clamps, sleeves; valve box and cover, valve tags, valve box, operating nut, and stem extension (if applicable); debris shield; placing and removing all traffic signs and barriers and maintaining traffic; furnishing all material, labor, tools and equipment; flushing; performing hydrostatic and leakage testing; and all incidental and related work required to complete the item. For HDPE installations, payment shall also include mechanical or flange connection joint adapters and associated electro-fused couplings.

#### **XVII.2. FURNISHING AND INSTALLING TAPPING SLEEVES AND VALVES**

The quantity to be paid for will be the actual number of units of each size furnished and installed. Payment for the work will be made at the contract unit price for each respective item and shall be full compensation for the item of work, complete, with all necessary excavation and backfill; jointing; adapter pieces; concrete supports (if applicable), mechanical restraints at valve; electronic ball markers; nuts, bolts, socket clamps, sleeves; valve box, valve box extension (if applicable) and valve box cover; debris shield; placing and removing all traffic signs and barriers and maintaining traffic; as-builts; furnishing all material, labor, tools and equipment; performing flushing and hydrostatic and leakage testing and all incidental and related work required to complete the item. For HDPE installations, payment shall also include mechanical or flange connection joint adapters and associated electro-fused couplings.

#### **XVII.3. FURNISHING AND INSTALLING VALVES OR FITTINGS IN EXISTING PIPELINES**

The quantity to be paid will be the actual number of each size and type valve or fitting furnished and installed. Payment for the work will be made at the contract unit price for each respective valve and shall be full compensation for the item of work, complete, including all required excavation; backfill; shutting down and de-watering the pipelines; bypass pumping; cutting openings in the pipelines to accept the new valve or fitting and removing, stockpiling or otherwise disposing of the existing pipe section or existing valve or fitting removed; furnishing and installing the new valve or fitting; furnishing and installing all necessary pipe, couplings, sleeves, pipe adapters, concrete supports, mechanical restraints on valve or fitting, electronic ball markers; nuts, bolts, glands, socket clamps; furnishing and installing access box and cover; valve box, operating nut, and stem extension (if applicable); furnishing all material, labor, tools, and equipment; and all incidental and related work required to complete the work of the item.

#### **XVII.4. FURNISHING AND INSTALLING AIR VALVES**

The quantity to be paid will be the actual number of air valve assemblies (as detailed) furnished and installed. Payment will be made at the contract unit price for each air valve assembly in manhole (and not in manhole) and shall be full compensation for the item of work, complete, including all excavation; backfill; tapping or cutting opening in pipelines; furnishing and installing air valve with all required appurtenances, manhole with specialty liner, frame and cover or aluminum door, all piping fittings and valves (gate, corp. stops, etc) between air valve and main, saddle, sleeve or tee fitting in main, all material, labor, tools and

# ***JEA Water and Wastewater Standards***

## ***801 Measurement and Payment***

equipment and all incidental and related work to complete the air valve assembly and associated piping between the air valve and the main.

### **XVIII. SUBMERSIBLE SEWAGE PUMPING STATIONS – SECTION IV - 433**

The Contractor's lump sum bid as set forth in the contract shall constitute full compensation for the work involved in this section including pump station improvements as shown on the drawings (wet well, pumps, standby power generator if applicable, piping, electrical and controls) and security fencing of the construction area; tree removal, clearing and grubbing as required; grassing of disturbed areas; silt fence, reinforced concrete driveway and site slab; site and driveway compacted A-3 soil fill material; all electrical conduit and service conductor to the service pole unless other established/indicated boundary is indicated. Lump sum price includes the work and improvements inside the landscape zone and those items listed above which are outside the landscape zone (including driveway, sod work, underground, power conduit, water service and associated service piping, etc.).

### **XIX. SPECIALTY COATINGS AND LININGS – SECTION IV - 446**

#### **XIX.1. LINING OR COATING NEW MANHOLE**

The Contractor's lump sum bid for manhole type and depth (in 2 ft. increments), as set forth in the contract, shall constitute full compensation for the work involved in this section. Lump sum price shall include all surface preparation, ring and cover coating (if applicable), disposal of all debris, installation of liner and warranty all as specified herein.

#### **XIX.2. LINING OR COATING EXISTING MANHOLE**

The Contractor's lump sum bid for manhole type and depth (in 2 ft. increments), as set forth in the contract, shall constitute full compensation for the work involved in this section. Lump sum price shall include all surface preparation, manhole rehabilitation, cone replacement (if applicable), ring and cover coating (if applicable), disposal of all debris, temporary plugging of existing lines, bypass pumping, installation of liner and warranty all as specified herein.

#### **XIX.3. LINING OR COATING EXISTING WETWELL**

The Contractor's lump sum bid for wet well diameter and depth as set forth in the contract shall constitute full compensation for the work involved in this section. Lump sum price shall include all surface preparation, wet well rehabilitation, disposal of all debris, temporary plugging of existing lines, bypass pumping, installation of liner and warranty all as specified herein.

### **XX. EMERGENCY GENERATOR (LESS THAN 600 KW) – SECTION IV - 472**

For new generators at existing pump stations, no additional payment shall be made for the work specified in Chapter IV. 7. - Section 472. The Contractor's lump sum bid as set forth in the Contract shall constitute full compensation for the work involved in this section and shall include auto transfer switch in enclosure, diesel engine driven generator set, switchgear, controls, fuel, fuel tank, stainless steel enclosure, generator foundation, fuel tank foundation, warranty, exhaust and muffler, testing and all accessories necessary for a complete and operable installation.

### **XXI. RECLAIMED WATER PIPING – SECTION V - 701**

#### **XXI.1. FURNISHING AND INSTALLING PIPELINE**

The quantity to be paid for will be the actual number of linear feet of each size, type and class of pipe actually installed. Measurement shall be made along the horizontal projection of the center line of pipe. No deduction in length will be made for the space occupied by valves or fittings. Payment for the work will be

# *JEA Water and Wastewater Standards*

## *801 Measurement and Payment*

at the contract unit price shown for each respective item and shall be full compensation for the item of work completed, including all required removal of grassing; silt fence, excavation; de-watering; native soil backfilling; laying and jointing pipe; pressure and leakage testing; potable water (if required); furnishing and placing steel decking over excavations; all sheeting, shoring, and bracing required to maintain excavations in a safe condition; protecting existing structures, utilities and property both public and private; placing and removing all traffic signs and barriers and maintaining traffic; cleaning up the site; installing silt fence and other erosion, sedimentation protection and control devices; furnishing and installing locate wiring, locate wire test stations locate wire related appurtenances and locate wire testing; furnishing all material, labor, tools, and equipment; as-builts; and all incidental and related work required to complete the work of the item. No additional payment shall be made for vertical deflection of the proposed pipeline to accommodate the installation (minimum required cover) of gate valves, but all costs shall be merged with the associated line item in the Bid Form.

### **XXI.2.FURNISHING AND INSTALLING FITTINGS**

The quantity to be paid for will be the actual number of fittings furnished and installed. Payment for the work will be made at the contract unit price and shall be full compensation for the items of work including furnishing and installing fittings and mechanical restraints at fitting joints, complete, with all necessary incidental work required to complete the work and all materials, labor, tools and equipment.

### **XXI.3.FURNISHING AND INSTALLING CASING**

The quantity to be paid for will be the actual number of linear feet of each size casing and method of installation actually installed. Measurement shall be made along the horizontal projection of the center line of the casing. Payment for the work will be made at the contract unit price and shall be full compensation for the items of work, complete, including casing pipe; all casing spacers; pipe joint restraints and total restraining system required on the carrier pipe (water main pipe); locate wiring; excavation; de-watering; placing and removing all traffic signs and barriers and maintaining traffic; as-builts; and all incidental work required to complete the work including all materials, labor, tools and equipment.

### **XXI.4.FURNISHING AND INSTALLING POLYETHYLENE WRAP**

The quantity to be paid for will be the actual number of linear feet of polyethylene wrap actually installed. Measurement shall be made along the horizontal projection of the center line of the pipe being wrapped including fittings and valves. Payment for the work will be made at the contract unit price and shall be full compensation for the items of work, complete, including all incidental work required to complete the work and all materials, labor, tools and equipment.

### **XXI.5.FURNISHING AND INSTALLING PIPE SUPPORTS**

The quantity to be paid for will be the actual number of supports furnished and installed. Payment for the work will be made at the contract unit price and shall be full compensation for the items of work, complete, including furnishing and installing supports, with all incidental work required to complete the work and all materials, labor, tools and equipment.

### **XXI.6.FURNISHING AND INSTALLING PIPE BELL RESTRAINT**

The quantity to be paid for will be the actual number of bell restraints or joint restraint gaskets, installed with the maximum required to be installed as indicated in the Restraint Joint Schedules counted in full 20-foot segments extending from the fitting or for carrier piping bell restraints as required. Payment for the work shall be made at the contract unit price and shall be full compensation for the items of work including furnishing and installing the bell restraint, or joint restraint gaskets, complete, with all necessary incidental work required, including all materials, labor and equipment. No payment will be made for thrust restraints



# ***JEA Water and Wastewater Standards***

## ***801 Measurement and Payment***

used for the Contractor's convenience in addition to the bell restraints called for in the Restraint Joint Schedules.

### **XXI.7.FURNISHING AND INSTALLING THRUST COLLAR**

If thrust collar (dead man) is used instead of bell restraints or the rods to length indicated on the Restraint Joint Schedules on dead end pipelines, payment shall be for each thrust collar installed (by size of pipe).

### **XXI.8.FURNISHING AND INSTALLING RECLAIMED WATER SERVICES**

The quantity to be paid for will be the actual number of service connections installed as detailed on Plate W-1, W-2 and W-5. Payment for the work shall be made at the contract unit price for each size of long or short side service type and shall be full compensation for the items of work including furnishing and installing the service piping; connection to water main and plugging of new service termination in meter box; corporation stop (standard or HDPE type); curb stop; locate wiring; boring (if required); flushing and disinfection; all required removal of grassing; excavation; de-watering; native soil backfill; furnishing and placing a steel decking over excavations; all sheeting, shoring, and bracing required to maintain excavations in a safe condition; protecting existing structures, utilities and property both public and private; placing and removing all traffic signs and barriers and maintaining traffic; as-builts; cleaning up the site; installing silt fence and other erosion, sedimentation protection and control devices; furnishing all material, labor, tools and equipment and all incidental and related work to complete the item. Payment for a "double 1-inch water service" shall include 1-1/2 inch connections to main, 1-1/2 inch poly pipe (long side service only), Y-fitting, 1-inch poly to meter boxes, two curb stops, other items as listed above to complete the water service installation to two customers (excluding meter boxes).

### **XXI.9.REPLACEMENT OF EXISTING RESIDENTIAL RECLAIMED WATER SERVICES**

The quantity to be paid for will be the actual number of each size service replaced. Payment for the work will be made at the contract unit price for each size of long, short type or double 1-inch service (including poly pipe to two meter boxes and associated curb stops and shall be full compensation for the items of work including furnishing and installing service piping; connection to water main; connection to existing private house service piping; corporation stop (standard or HDPE type), curb stop, and service fittings; meter couplings; removal of old service piping (if applicable); cutting and threading existing pipe; all necessary jointing; removing, adjusting and resetting existing meter boxes; all required removal of grassing; excavation; de-watering; native soil backfill; furnishing and placing steel decking over excavations; all sheeting, shoring, and bracing required to maintain excavations in a safe condition; flushing, protecting existing structures, utilities and property both public and private; placing and removing all traffic signs and barriers and maintaining traffic; as-builts; cleaning up the site; furnishing all material, labor, tools and equipment; and all incidental and related work to complete the item.

## **XXII. RECLAIMED WATER VALVES AND APPURTENANCES - SECTION V - 702**

### **XXII.1. FURNISHING AND INSTALLING VALVES**

The quantity to be paid will be the actual number of each size and type of valve furnished and installed. Payment for the work will be made at the contract unit price and shall be full compensation for the item of work including furnishing and installing the valve, complete, with all required excavation and backfill; necessary jointing; adapter pieces; concrete supports (if applicable); mechanical restraints at valve; electronic ball markers; nuts, bolts, socket clamps, sleeves; valve box and cover, valve tag, valve box, operating nut, and stem extension (if applicable) and valve box cover; placing and removing all traffic signs and barriers and maintaining traffic; furnishing all material, labor, tools and equipment; flushing; performing hydrostatic and leakage testing and all incidental and related work required to complete the item. For HDPE

# *JEA Water and Wastewater Standards*

## *801 Measurement and Payment*

installations, payment shall also include mechanical or flange connection joint adapters and associated electro-fused couplings.

### **XXII.2. FURNISHING AND INSTALLING TAPPING SLEEVES AND VALVES**

The quantity to be paid for will be the actual number of units of each size furnished and installed. Payment for the work will be made at the contract unit price for each respective item and shall be full compensation for the item of work, complete, with all necessary excavation and backfill; jointing; adapter pieces; concrete supports (if applicable); mechanical restraints at valve; electronic ball markers; nuts, bolts, socket clamps, sleeves; valve boxes, valve box extensions (if applicable) and valve box covers; placing and removing all traffic signs and barriers and maintaining traffic; as-builts; furnishing all material, labor, tools and equipment, performing hydrostatic and leakage testing and all incidental and related work required to complete the item. For HDPE installations, payment shall also include mechanical or flange connection joint adapters and associated electro-fused couplings.

### **XXII.3. FURNISHING AND INSTALLING RECLAIMED WATER METER BOXES**

The quantity to be paid will be the actual number of units of each size furnished and installed. Payment for the work will be made at the contract unit price for each respective item and shall be full compensation for the item of work, complete.

### **XXII.4. FURNISHING AND INSTALLING VALVES OR FITTINGS IN EXISTING PIPELINES**

The quantity to be paid will be the actual number of each size valve or fitting furnished and installed. Payment for the work will be made at the contract unit price for each respective valve or fitting and shall be full compensation for the item of work, complete, including all required excavation; backfill; shutting down and de-watering the pipelines; cutting openings in the pipelines to accept the new valve or fitting and removing, stockpiling or otherwise disposing of the existing pipe section or existing valve or fitting removed; furnishing and installing the new valve or fitting; furnishing and installing all necessary pipe couplings, sleeves, pipe adapters, concrete supports, mechanical restraints on valve or fitting, electronic ball markers; nuts, bolts, glands, socket clamps; furnishing and installing valve box, valve box extension (if applicable) and valve box cover; placing and removing all traffic signs and barriers and maintaining traffic; as-builts; furnishing all material, labor, tools, and equipment; flushing; performing hydrostatic and leakage testing; and all incidental and related work required to complete the work of the item.

### **XXII.5. FURNISHING AND INSTALLING FLUSHING VALVE**

The quantity to be paid will be the actual number of each type (above or below grade) flushing valve assembly furnished and installed. Payment for the work will be made at the contract unit price for each flushing valve assembly and shall be full compensation for the item of work, complete, including all required excavation; backfill; installing box and cover; valves; piping; bedding; flushing; furnishing all material, labor, tools and equipment; and all incidental and related work to complete the item into the JEA system (from Chapter III. 1. - Section 350).

### **XXII.6. FURNISHING AND INSTALLING AIR RELEASE VALVES**

The quantity to be paid will be the actual number of air valve assemblies (as detailed) furnished and installed. Payment will be made at the contract unit price for each air valve assembly in manhole (or not in manhole) and shall be full compensation for the item of work, complete, including all excavation; backfill; tapping or cutting opening in pipelines; furnishing and installing air valve with all required appurtenances, manhole (if applicable) with frame and cover or aluminum door, all piping fittings and valves (gate, corp. stops, etc.) between air valve and main, saddle, sleeve or tee fitting in main, all material labor, tools and

# *JEA Water and Wastewater Standards*

## *801 Measurement and Payment*

equipment and all incidental and related work to complete the air valve assembly and associated piping between the air valve and the main.

### **XXIII. HORIZONTAL DIRECTIONAL DRILLING – SECTION VI - 750 AND 755**

#### **XXIII.1. DIRECTIONAL DRILLING FUSION WELDED PIPE**

The quantity to be paid for will be the length in linear feet of each size of fusion welded pipe furnished and installed. Measurement shall be made along the horizontal centerline of the pipe installed as shown on the plans. (The contractor shall include in the contract unit price its allowance for horizontal deflection, vertical deflection and all wastage). Payment for installed pipe will be at the contract unit price shown for each respective pipe size and shall be full compensation for the item of work completed, including project planning and shop drawings; horizontal directional drilling, laying and jointing pipe; locate wire system; pressure and leakage testing; swabbing, flushing, potable water (if required); and disinfection (potable and raw water mains only) and dechlorination (if necessary); protecting existing structures, utilities and property both public and private; cleaning up the site; furnishing all material, labor, tools, and equipment; and all incidental and related work required to complete the installation including entry/back reaming pits, dewatering, as-builts, placing and removing all traffic signs and barriers, maintaining traffic, and site preparation. Contractor shall be responsible for removal and disposal of drill fluid breakouts. Damage to roadways; existing utilities, property both public and private occurring due to the work shall require complete restoration to the satisfaction of the JEA. No separate payment will be made for cleanup, or restoration due to damage, and all associated costs shall be borne by the Contractor. Should JEA elect the swabbing of mains sized 12 and smaller, the work shall be performed by the Contractor via a Supplemental Work Authorization. No separate payment shall be made for swabbing of mains larger than 12 inches in diameter.

#### **XXIII.2. FUSION WELDED FITTINGS**

The quantity to be paid for will be the actual number of fittings furnished and installed unless otherwise noted in the Measurement and Payment items. Payment for the work will be made at the contract unit price and shall be full compensation for the items of work including furnishing fusion welding, and installing fittings including any necessary mechanical or flange connection adapters, electrofused couplings, complete, with all necessary incidental work required to complete the work and all materials, labor, tools, and equipment.

## **SECTION III – WATER DISTRIBUTION SPECIFICATIONS**

350 - Potable Water Piping

351 - Water Meters, Valves, Hydrants and Appurtenances

*Blank Page*

## **350 - POTABLE WATER PIPING**

### **I. GENERAL REQUIREMENTS**

#### **I.1. SCOPE OF WORK**

The Contractor shall furnish and install a potable water piping system, complete, tested and ready for operation. The work shall also include such connections, reconnections, temporary service and all other provisions in regard to the existing operation and modification as is required to perform the new work. All references to Industry Standards (ASTM, ANSI, AWWA, etc.) shall be to the latest revision unless otherwise stated. Only those materials included in the JEA Water and Wastewater Standards Manual shall be installed. All materials shall be new unless specifically called for otherwise and shall adhere to the 2014 EPA standards for lead free brass. For the supply of domestic water during construction, the contractor shall utilize a JEA meter assembly (meter & back flow device) except in the case where the new main is connected directly into the active water system for line filling and flushing operation. Un-metered reclaimed water may be utilized for flushing and testing of new reclaimed water mains. Un-accountable domestic water quantities shall be minimized, where possible.

#### **I.2. PROJECT SCHEDULE AND COOPERATION**

The project schedule shall be established on the basis of working a normal work schedule including five days per week, single shift, eight hours per day or four days per week, single shift, ten hours per day. Unless approved otherwise by JEA, normal or general items of work, such as bacteriological testing, leakage and pressure testing, density testing and final inspections, shall be scheduled during the normal work schedule. Due to operational and manpower limitations on the JEA systems, JEA will require the contractor to perform work outside of the normal work schedule. These operational and manpower limitations, including but not limited to, line filling and flushing operation, tie-in work (cut-in work or other tie-in work) and other phases of the work which may impact the continued (non-interruptible) service to existing JEA customers. The contractor shall plan and anticipate the cost impact of these system limitations and provide such work or services at no additional cost to JEA.

#### **I.3. SHOP DRAWING SUBMITTALS**

Actual catalog data, brochures and descriptive literature will not be required for items of standard usage, which meet the requirements of Chapter X. and Chapter XI. of the JEA Water and Wastewater Standards Manual. Any specialty item not shown in this manual will require a complete shop drawing submittal. The Engineer may at any time require the Contractor to provide a complete detailed shop drawing submittal for any material, which may, in the Engineer's opinion, not be in compliance with the JEA Water and Wastewater Standards.

#### **I.4. AS-BUILT DRAWING**

As-built drawings to be utilized in future utility locate work are required on all water, wastewater, force main, pump station, chiller lines and reclaimed water projects, including projects for JEA, City of Jacksonville, JTA, DOT, private developments (utilities to be dedicated to JEA), and other City Authorities, etc. As-built drawings shall be in accordance with Chapter VI. 1. - Section 501, entitled "As-built Drawings". As built drawings shall be reviewed and approved by JEA. The cost to provide as-built drawings shall be included as part of the related work requirements or general conditions for the utility work. In addition, as-built drawings are required which meet current regulatory rules regarding "water main clearances" and "certification of completion" rules regarding (C.O.C.).

# *JEA Water and Wastewater Standards*

## *350 Potable Water Piping*

### **I.5. WARRANTY**

The Contractor shall provide to JEA a two (2) year unconditional warranty after substantial project completion or any designated portion thereof or after total project acceptance. The warranty shall include materials and installation and shall constitute complete replacement and delivery to the site of materials and installation of same to replace defective materials or defective workmanship with new materials/workmanship conforming to the specifications.

### **I.6. INSPECTION CHECKLISTS**

Contractor shall schedule a final walk through (prior to substantial completion) in order to create a punch list for each project. List of attendees shall include but not be limited to the Contractor's representative, JEA representative (ie. project inspector), and designated JEA Operation personnel. The Contractor's representative shall complete the associated JEA Final Inspection Checklist for each and have the JEA attendees provide original signatures/names on the signature block.

### **I.7. LOCATE WIRE BOX AND INSPECTION CHECKLIST**

I.7.1. All Locate wire boxes shall be outside of driveways, sidewalk and pavement. Locate wire boxes are to be marked on the curb, cut with a "LW" and the color of the utility it serves.

I.7.2. Locate wire shall be installed on hydrant independent valves and no access points on a potable water, reclaim, sewer force main should be missed.

I.7.3. On new installations, splices should be minimal unless a repair is required.

I.7.4. Contractor shall be required to provide a crew complete with all necessary equipment to allow observation of each new locate wire box. The Contractor's representative shall complete the associated JEA "Final Inspection Checklist" located on JEA.com for each new locate wire box, and have the JEA attendees provide original signatures/names on the signature block. Locate wire certification email address [locatewire@jea.com](mailto:locatewire@jea.com) for submittals of final testing results.

## **II. MATERIALS**

All material shall be free from defects impairing strength and durability, shall be of the best commercial quality for the purpose specified, and shall have structural properties sufficient to safely sustain or withstand strains and stresses to which it is normally subjected and be true to detail.

### **II.1. PIPE**

Pipe for potable water lines in sizes up to 16 inches direct bury shall be ductile iron, polyvinyl chloride (PVC) or high density polyethylene (HDPE), as shown on the drawings and as herein specified. Pipe for potable water lines 20" and larger direct bury shall be ductile iron. Pipe to be used as a casing in sizes 4 inches and larger shall be welded steel pipe as shown on the drawings and as herein specified. Pipe to be installed underground shall be push-on joint type. Pipe installed on bridges, piles or other above ground installations shall be push-on restrained or mechanical joint utilizing fast-grip gaskets, gaskets, restrained mechanical joint ductile iron pipe or flanged ductile iron pipe as described in these specifications (Bell and rod restraints shall not be used unless approved otherwise by JEA). PVC pipe shall not be used in above ground applications. Underground pipe shall be furnished in nominal 18 or 20 foot laying lengths unless indicated otherwise on the drawings. Pipe shall be cut to length as required to fit installation conditions. PVC or HDPE piping shall not be utilized on bridges or other above ground applications. For water mains and service lines (from main pipe to back flow device) in contaminated soils (as defined by regulatory agencies), ductile iron pipe with nitrile (NBR) gasket material shall be utilized on 4-inch and larger pipes, and galvanized pipe shall

# JEA Water and Wastewater Standards

## 350 Potable Water Piping

be utilized on 2-inch and smaller pipes (the use of PVC or HDPE pipe shall be prohibited). Pipe sizes and applications shall conform to the following chart.

PIPE	PIPE SIZE	JOINT TYPE	APPLICATION
Ductile Iron	4 inches and larger *	Mechanical joint, push-on joint, flanged joint, ball joint, etc.	water mains and services (above ground or below ground)
	3 inches	Mechanical joint, push-on joint	water service only (below ground)
PVC DR14, DR18 (C900)	4 -12 inches *	Push-on joint	water mains and services (below ground)
PVC DR14, DR18, DR25 (C905)	16-inches only	Push-on joint	water mains and services (below ground)
PVC DR-18 (fusible joints)	4-12 inches *	Fusible-PVC	water mains & services (below ground)
SCH 40 PVC	2 inches only	Solvent Weld	water mains only (below ground)
SCH 80 PVC	2 inches only	Solvent Weld	water mains only (below ground)
SDR 21 PVC	2 inches only	Push-on joint	water mains only (below ground)
Polyethylene	2 inches and smaller	No mechanical joints in pipe under roadway	services only (below ground)
Polyethylene (HDPE)	4 inches and larger	Fused (no more than 3 fused joints per 20 foot section)	directional drill or pipe bursting only, unless approved by JEA (below ground)
Galvanized	smaller than 3 inches	I.P.T.	contaminated soil sites (below ground)
Steel	4 inches and larger	Welded	casing only

\*Pipe sizes 14" and 18" shall not be utilized unless specifically approved by JEA with the exception of HDPE.

### II.1.1. DUCTILE IRON PIPE

Ductile iron pipe wall thickness and pressure class shall conform to ANSI Specification ANSI A21.50 (AWWA C150) and ANSI A21.51 (AWWA C151) with pressure class 150 as a minimum. Pipe shall also be certified by ISO 9000 by an accredited registrar. Each length shall be clearly marked with the name of the manufacturer, location of the foundry, pressure rating, thickness or pressure class, nominal pipe diameter, weight of pipe without lining and length. All pipe furnished



# *JEA Water and Wastewater Standards*

## *350 Potable Water Piping*

by the manufacturer shall be cast and machined at one foundry location to assure quality control and provide satisfactory test data. All ductile iron pipe shall be externally coated and internally lined as specified in this section. All ductile iron pipe shall be color coded blue by field applying a 3-inch wide utility marking tape (tape with adhesive backing), along the crown of the pipe barrel. For large diameter pipe (12 inches and greater), a filler gauge may be utilized during the installation to check for rolled gaskets.

### **II.1.2. POLYVINYL CHLORIDE PRESSURE PIPE**

Pipe shall be virgin polyvinyl chloride (PVC) pipe for potable water and shall have a bell type coupling with a thickened wall section integral with the pipe barrel in accordance with ASTM D3139. Elastomeric seals shall meet ASTM F477 and shall be attached to the bell utilizing glue (AWWA and manufacturer approved type) or rieber ring. The pipe material shall be clean, virgin, National Sanitation Foundation No.14 approved, Class 12454-A or 12454-B PVC compound conforming to ASTM resin specification D1784. Each length shall be clearly marked with the name of the manufacturer, location of the plant, pressure rating, nominal pipe diameter and length. Storage and handling of PVC pipe shall be in accordance with chapter 6 of AWWA Manual M23. All PVC potable water pipe shall be blue. All PVC raw water main piping shall be white with a 3-inch wide warning tape (non-detectable type) which indicates "RAW WATER MAIN".

#### **II.1.2.1. PVC 1120, Class 100, DR 25 Pipe**

Pipe shall conform to AWWA Standard C905 for 16-inch pipe. Pipe is to be manufactured to ductile iron pipe equivalent outside diameters.

#### **II.1.2.2. PVC 1120, Class 150, DR 18 Pipe**

Pipe shall conform to AWWA Standard C900 for 4 inch through 12-inch pipe. Pipe is to be manufactured to ductile iron pipe equivalent outside diameters.

#### **II.1.2.3. PVC 1120, Class 200, DR 14 Pipe**

Pipe shall conform to AWWA Standard C900 for 4 inch through 12-inch pipe. Pipe is to be manufactured to ductile iron pipe equivalent outside diameters.

#### **II.1.2.4. PVC 1120, PR 200, SDR21 Pipe**

Pipe shall conform to ASTM D2241 and shall be used only for the construction of 2-inch water mains. Blue color pipe is preferred, but if not available then white or grey color pipe may be utilized with the addition of 3-inch wide (minimum) non-detectable utility tape (tape with an adhesive backing). Pipe is to be manufactured to I.P.S. (Steel) Standard Pipe equivalent outside diameters. Pipe shall be marked NSF- PW approved.

#### **II.1.2.5. PVC 1120, Schedule 40 and Schedule 80 Pipe**

Pipe shall conform to ASTM D1784 and D1785 and shall be used only for the construction of 2-inch water mains. Blue color pipe is preferred, but if not available then white or grey color pipe may be utilized with the addition of 3 inch wide (minimum) non-detectable utility tape (tape with an adhesive backing). Pipe is to be manufactured to I.P.S. (Steel) Standard Pipe equivalent outside diameters. Pipe shall be marked NSF- PW approved. To ensure water tight connection, the contractor shall utilize "purple primer" and "rain or shine glue" or JEA approved equal.

### **II.1.3. STEEL CASING PIPE**

# ***JEA Water and Wastewater Standards***

## ***350 Potable Water Piping***

Pipe to be used as a casing shall conform to either ASTM Standard A139 for "Electric Fusion (arc) Welded Steel Pipe" with minimum yield strength of 35,000 psi or "API Specification API-5LX, Grade X-42 Welded Steel Pipe". Wall thickness shall meet the requirements of the latest Revision of the American Railway Engineering Association Manual of Recommended Practice or the Florida Department of Transportation Standard Specification for Road and Bridge Construction, as applicable. For street uses, which are not DOT or railroad, use DOT casing thickness unless otherwise indicate by Engineer. All pipe furnished by the manufacturer shall be cast and machined at one foundry location to assure quality control and provide satisfactory test data. Full pipe length shall be provided. No short pipe lengths less than 8 feet long will be allowed unless approved by JEA. The pipe ends shall be tapered where welding is required.

### **II.1.4. GALVANIZED PIPE**

Galvanized pipe shall be 2-inch for flushing hydrants or for contaminated soil sites (when specified) only. Galvanized pipe shall be schedule 40, hot-dipped galvanized, welded (seamless) pipe in accordance with ASTM A53. Pipe is to be manufactured to I.P.S. (Steel) Standard Pipe Equivalent outside diameters. No color code on the pipe is required.

### **II.1.5. HIGH DENSITY POLYETHYLENE (HDPE) PIPE**

It should be noted that the use of this product (especially for DR-11 pipe) may require up-sizing the main so that the inside diameter is approximately the same as PVC size where applicable. See Horizontal Directional Drilling (Chapter VI. 2. - Section 750 and 755) for technical specifications for this product and associated construction standards.

### **II.1.6. POLYETHYLENE TUBING SERVICE LINES AND MAINS (2-INCH AND SMALLER)**

All services and mains 2 inches and smaller shall be polyethylene tubing. Tubing shall be manufactured of PE 4710, High Density Polyethylene (HDPE), in accordance with AWWA C901, ASTM D1248, ASTM D2239, ASTM D2737 and ASTM D3350. The tubing shall have a minimum working pressure of 250 psi. Polyethylene tubing shall be copper tube size SDR-9 and shall be colored blue. HDPE pipe shall have ultraviolet (UV) inhibitors for protection against direct sunlight for 1 year. Inserts for polyethylene tubing may be utilized, at contractors' options, and, if used, shall be 316 stainless steel. The use of no-lead brass couplings, tees and "Y" fittings are acceptable on poly service tubing, if not located under the roadway. Tubing shall be approved for use with potable water by the National Sanitation Foundation (NSF-14) and shall be continuously marked at intervals of not more than four feet with the following:

- Nominal size
- Pressure rating
- NSF seal
- Manufacturer's name or trademark
- Standard dimension ratio
- ASTM specification

### **II.1.7. FUSIBLE PVC PIPE (4"-12" SIZE)**

May be used on potable water or reclaimed water systems. Fusible PVC may be utilized for directional drilling and direct bury applications. Pipe shall meet C-900 pressure class, DR-18 wall thickness and color coded. The pipe shall be marked with the name and location of the manufacturer, pressure rating and size. Unless approved otherwise by JEA, the bending radius

# *JEA Water and Wastewater Standards*

## *350 Potable Water Piping*

shall not exceed 50% of the manufacturer's recommendation and the pulling force shall not exceed 80% of the manufacturer's recommendation.

### **II.2. FITTINGS**

Fittings shall have joints that match the type of pipe furnished except as follows or as otherwise specified. PVC fittings (2-inch size) may be push-on bell type joint or solvent weld. Fittings 3 inches and larger on push-on joint pipe installed underground shall be ductile iron with restrained mechanical joint ends or PVC with restrained push-on bell type joint. Fittings 3 inches and larger installed above ground shall be ductile iron with flanged ends or restrained joints unless shown otherwise on the drawings

#### **II.2.1. DUCTILE IRON FITTINGS**

Ductile iron fittings shall have a minimum working pressure of 250 psi. Fittings shall conform to ANSI Specification A21.10 (AWWA C110), A21.11 (AWWA C111), A21.15 (AWWA C115) and/or A21.53 (AWWA C153). Fittings shall also be certified by ISO 9000 by an accredited registrar. Compact fittings shall normally be installed. Long body fittings shall be used where the drawings specifically call for long body fittings, where compact fittings are not available, or at the option of the Contractor when the laying length is not controlled by compact fitting patterns. All fittings shall be UL/FM approved and shall conform to NSF Standard 61 as applicable. All fittings furnished by the approved manufacturer shall be cast and machined at one foundry location to assure quality control and provide satisfactory test data. Fittings shall have cast on them the pressure rating, nominal diameter of openings, manufacturer's name, foundry location, plant code and degrees or fraction of the circle. Cast letters and figures shall be on the outside body of the fitting. The JEA may require random ductile testing of manufacturer's fittings. All ductile iron fittings shall be externally coated and internally lined as specified in this section. Ductile iron welded-on outlets are not acceptable. In lieu of ductile tee/fittings, a tapping sleeve may be utilized on 24-inch and larger (D.I.P. or PVC) pipe for outlets 12-inch and smaller.

#### **II.2.2. POLYVINYL CHLORIDE FITTINGS**

Fittings that are 2-inch may be PVC with push-on bell type joint or PVC with solvent weld joints as outlined above. Fittings that are 4 inches and larger shall be restrained push on bell joint. Restraints shall be in accordance with this specification regarding installation and material. The fittings shall conform to the appropriate sections of these specifications for PVC pipe and PVC pipe joints.

##### **II.2.2.1. PVC 1120, Class 150, DR18 Fittings**

PVC fittings 4-inch through 12-inch may be used with PVC C900 pipe. Fittings shall be PVC injection molded, made from materials meeting or exceeding the requirements of cell class 12454-B material as defined in ASTM D1784. All PVC fittings must comply with, or exceed, AWWA C907. All fittings must be designed to the pressure class of DR18, with a pressure rating of 150 psi and a 2.5 to 1 factor of safety. Virgin materials only shall be used in the manufacture of PVC pressure fittings. These fittings must have UL-FM approval and shall comply with or exceed all ASTM Standards for PVC fittings. All fittings must have NSF-61 approval. The elastomeric gasket shall comply with the requirements specified in ASTM F477 and shall be attached to the bell utilizing glue (AWWA and manufacturer-approved type) or rieber ring.

##### **II.2.2.2. PVC 1120, SDR 21, Fittings**

SDR 21 fittings shall be injection molded, push on bell type with elastomeric rubber seals in accordance with ASTM D3139. Seals shall conform to ASTM F477.

# *JEA Water and Wastewater Standards*

## *350 Potable Water Piping*

### II.2.2.3. PVC 1120, Schedule 40 and Schedule 80 Fittings

Schedule 40 and Schedule 80 fittings shall have solvent weld joints and shall be in accordance with ASTM D2672.

### II.2.3. POLYETHYLENE FITTINGS

See "Horizontal Directional Drilling", (Chapter VI. 2. - Section 750), for technical specifications for this product and associated construction standards.

### II.2.4. NONSTANDARD FITTINGS AND WALL CASTINGS

Fittings having nonstandard dimensions and cast specifically for this project shall be of approved design. They shall be manufactured to meet the requirements of the same specifications and shall have the same diameter and thickness as standard fittings, but their laying lengths and types of ends shall be determined by their positions in the pipelines and by the particular piping to which they connect. Wall castings shall be of the size and types indicated on the drawings. Flanges, facing, and drilling shall conform to the 125-pound American National Standard. Flanges shall be drilled and tapped for studs. Other dimensions shall be substantially equal to corresponding parts of standard bell and spigot fittings.

## II.3. JOINTS

Type of joint used shall meet the following specifications or be approved by the Engineer prior to installation. Joints shall be made in accordance with approved printed instructions of the manufacturer, and shall be absolutely watertight.

### II.3.1. MECHANICAL JOINTS

All jointing materials for mechanical joints shall be provided by the pipe and/or fitting manufacturer. Material assembly and bolting shall be in accordance with ANSI Specification A21.11 (AWWA C111). All glands shall be made of ductile iron only.

### II.3.2. PUSH-ON JOINTS

#### II.3.2.1. Ductile Iron

Push-on joints shall be in accordance with ANSI Specification A21.11 (AWWA C111). All joint material shall be provided by the pipe manufacturer and installation shall be in accordance with the manufacturer's recommended practice.

#### II.3.2.2. Polyvinyl Chloride (PVC)

PVC pipe joints shall be the manufacturer's standard push-on bell type with rubber sealing ring in accordance with ASTM D3139. Elastomeric gaskets shall conform to ASTM F477.

### II.3.3. BALL AND SOCKET JOINTS

Where subaqueous joints are indicated, joints shall be bolted or boltless flexible ball and socket joints conforming to the pressure and thickness requirements of ANSI A21.10 (AWWA C110) and ANSI A21.51 (AWWA C151) and shall be capable of providing a maximum deflection of fifteen degrees at each joint. Joints and gasket material shall be manufacturer's standard. The specific type joint shall be as shown on the drawings and/or as approved by the Engineer. Installation shall be in accordance with the manufacturer's recommended practice.

# *JEA Water and Wastewater Standards*

## *350 Potable Water Piping*

### **II.3.4. FLANGED JOINTS**

Ductile iron flanged joints shall conform to ANSI A21.10 (AWWA C110) and ANSI A21.15 (AWWA C115). Flanges shall be in accordance with ANSI Specification B16.1, Class 125 with any special drilling and tapping as required to insure correct alignment and bolting. Screwed flanges shall be screwed in tight at the foundry by machine before they are faced and drilled. Flanges for flanged joints and flanged specials shall be integrally cast at right angles to the axis, accurately faced, and drilled smooth and true. Gaskets shall be rubber ring type, cloth inserted, with minimum thickness of 1/8 inch and shall be used on all flanges. The entire gasket, including the retainer and sealing ring, shall be one continuous piece. Retainers glued together will not be accepted. Flanged joints shall be made with bolts, bolt studs with a nut on each end, or studs with nuts where the flange is tapped. The number and size of bolts shall conform to the same ANSI standard as the flanges. Bolts and nuts shall be of Grade B conforming to the ASTM Specifications for steel machine bolts and nuts and tap bolts, designation A307. Bolt studs shall be of the same quality as machine bolts. Bolts shall be tightened so as to distribute evenly the stress in the bolts and bring the pipe in alignment. The Contractor shall provide suitable filling rings where the layout of the flange piping is such as to necessitate their use. In materials, workmanship, facing and drilling, such rings shall conform to ANSI B16.1 Class 125.

### **II.3.5. MACHINED SURFACES**

Machined surfaces shall be cleaned and coated with a suitable rust preventive coating at the shop immediately after being machined.

### **II.3.6. STEEL CASING JOINT PIPES**

Steel casing pipe joints shall be electric fusion (arc) welded by operators whose qualifications meet the requirements of the American Welding Society Standard procedures and in conformance with AWWA C206. For field welds, the joints to be welded shall be tapered (approximately 45-degree taper).

### **II.3.7. POLYVINYL CHLORIDE SOLVENT WELD JOINTS**

Pipe joints for schedule 40 or schedule 80 pipe shall be solvent weld joints. The solvent cement shall comply with ASTM D2564. The joint shall be made in accordance with ASTM D2855. The joint shall conform to ASTM D2672.

### **II.3.8. POLYETHYLENE JOINTS**

Polyethylene joints shall be butt-fused, done with polyethylene fittings or no-lead brass compression fittings.

### **II.3.9. RESTRAINED JOINTS**

The restrainer shall be manufactured of ductile iron and shall meet or exceed all the requirements of ANSI A21.11 (AWWA C111) and ASTM A536. The restrainer system shall provide anchoring ductile iron pipe and fittings, valves and PVC pipe to mechanical joint pipe or fittings, or bell to spigot PVC pipe joints. The restrainer shall accommodate the full working pressure rating of the pipe plus surge allowance. In the assembly of the restraint device, the contractor shall tighten the bolts to the correct torque range as recommended by the restraint manufacturer. The restrainers shall be painted black for ductile iron pipe and painted red for PVC pipe applications. The restraining device shall not damage or lower the working pressure of the pipe installed. Restrainers shall be properly stored to minimize sand and debris build-up. Specifically, the twist-off-screws and associated threads shall be clean (free of sand) prior to installation.

# ***JEA Water and Wastewater Standards***

## ***350 Potable Water Piping***

### **II.3.10. RESTRAINERS SPECIFICALLY FOR DUCTILE IRON PIPE**

Joints may be restrained by utilizing a joint restraint gasket which includes a stainless steel locking segments vulcanized into the rubber gasket. The gasket shall be rated for operating pressures up to 250 psi based on the performance requirements of ANSI/AWWA C111/A21.11, Standard for Rubber – Gasket Joints of D.I.P. & F. Pipe Manufacturer's restraints for joint restraints designed for operating pressures of up to 250 psi minimum will also be acceptable if approved by JEA.

### **II.3.11. FLANGE ADAPTERS**

Flanged adapters shall only be utilized if no other method is possible. Flange adapters shall be ductile iron manufactured to ASTM A536 standards. Bolt circles and bolt holes shall meet ANSI B16.1 for 125 pounds. Adapter flanges shall meet or exceed all test requirements of AWWA C900, ASTM D2241 and ASTM D1599.

### **II.3.12. PIPE COUPLINGS**

The Contractor shall furnish and install pipe couplings as required to complete the work. Pipe couplings used to join two pieces of ductile iron pipe or PVC pipe shall be sized to match the outside diameter of the pipeline. Transition couplings shall be used to join pipes of different outside diameters. The coupling sleeve shall be manufactured of ductile iron conforming to ASTM A536 and be coated with 14 mils of epoxy. The bolts shall be manufactured of a metal of high corrosion resistance and shall conform to ANSI 21.11 (AWWA C111). Gaskets shall be wedge-type and manufactured of virgin SBR for water and wastewater service. The installation of all couplings shall be in accordance with latest manufacturer's recommendations. Unless approved otherwise by JEA, the maximum gap between pipe ends shall be: (based upon sleeve length) 5" sleeve, 1" gap; 7" sleeve, 2" gap, 10" sleeve, 3-1/2" gap; other per manufacturer's recommendation. Couplers and adapters for polyethylene pipe shall be no-lead brass conforming to AWWA C800 and shall be female IPS, pack joint or compression nut.

### **II.3.13. FULL CIRCLE REPAIR CLAMPS**

Full circle repair clamps shall have type 304 stainless steel shells, lugs, bolts, nuts and washers as per ASTM A193, A194, A240, or shall have type 304 stainless steel shells per ASTM A240, ductile iron lugs as per ASTM A536, and 304 stainless steel bolts, washers and nuts. Gaskets for both types shall be virgin SBR as per ASTM D2000 for water service. Minimum lengths shall be 7½" long for 6" nominal and smaller pipe, 12" long for 8" – 12" nominal pipe and 20" long for pipes larger than 12" nominal pipe.

### **II.3.14. EXPANSION JOINT FITTINGS**

Flexible expansion joints shall be installed in the locations indicated on the drawings and shall be manufactured of ductile iron. The type, location and quantity of expansion joint fittings shall be specifically designed by the design engineer and shown on the construction drawings. The expansion joint shall be designed to protect the pipe main against damage from thermal linear expansion. Linear expansion joints shall be factory-set for 50% expansion/50% contraction. The expansion joint may include an integral ball and socket type flexible joint. The fitting shall be lined with a minimum of 15 mils of fusion-bonded epoxy. The expansion joint fitting shall be pressure tested to 350 psi (250psi for 30-inch and larger). Acceptable manufacturers include EBAA Iron, Star or approved equal.

## **II.4. CORROSION PROTECTION FOR DUCTILE IRON PIPE**

### **II.4.1. INTERIOR LINING**

# ***JEA Water and Wastewater Standards***

## ***350 Potable Water Piping***

The interior of all ductile iron pipe, fittings and specials shall be thin cement lined with a seal coat. The lining shall comply with ANSI Standard A21.4 (AWWA C104). High-speed cement lining, (offered by American Pipe) is acceptable with no seal coat.

### **II.4.2. EXTERIOR COATING**

II.4.3. All ductile iron pipe and fittings except as otherwise noted, shall receive an exterior bituminous coating as specified in ANSI A21.51. The finished coating shall be continuous smooth, neither brittle when cold nor sticky when exposed to the sun, and be strongly adherent to the fitting. In areas where soils are corrosive in nature, all bolts, nuts, studs and other uncoated parts of joints for underground installation shall be coated with asphalt or coal-tar prior to backfilling. Corrosive soil shall be defined as described in AWWA-C105, appendix "A".

### **II.4.4. MARKING FOR DUCTILE IRON PIPE AND 2" PVC PIPE**

All ductile iron pipe and 2" PVC pipe below ground shall be marked with a 3 inch wide (minimum), non-detectable utility marking tape (tape with an adhesive backing). The utility marking tape shall be installed on the pipe at the 12:00 o'clock position. Tape shall be 4 mil (minimum) ASTMD2103 thickness constructed for prolonged use underground, meet the industry standards (APWA) color code, tensile strength of 2750 psi (ASTM D882), and industrial standard repeatable message. All ductile iron pipe above ground (including bridge crossing) shall be color labeled "Water" stenciled in the center of each joint of pipe utilizing oil based paint. Stenciled lettering shall be 4" (minimum), high lettering and be blue color.

### **II.4.5. POLYETHYLENE WRAP**

In areas where soils are corrosive in nature, ductile iron pipe, fittings, valves and other appurtenances shall be protected with polyethylene wrap or tubing. Corrosive soil shall be defined as described in AWWA-C105, appendix "A". The Contractor shall furnish and install polyethylene tube or wrap for ductile iron pipe at the locations shown on the construction drawings or as directed by JEA.

#### **II.4.5.1. Material**

The polyethylene material shall meet or exceed the requirements of ANSI A 21.5/AWWA C105 in all respects. The wrap shall be virgin, high density polyethylene, 4 mils thick minimum cross laminated type or 8 mils linear low density type. The polyethylene wrap shall be included industrial standard repeatable message blue color.

#### **II.4.5.2. Installation**

Although not intended to be a water-tight enclosure, the polyethylene shall prevent contact between the pipe and the surrounding backfill. Installation shall be done according to one of the methods described in AWWA C105, subject to approval by the Engineer and the manufacturer.

## **II.5. PIPING SUPPORTS**

II.5.1. The Contractor shall furnish and install all supports necessary to hold the piping and appurtenances in a firm, substantial manner at the lines and grades indicated on the drawings or as specified.

# JEA Water and Wastewater Standards

## 350 Potable Water Piping

II.5.2. Piping within pumping stations shall be adequately supported from floors, walls, ceilings or beams. Supports from the floor shall be by approved saddle stands or suitable concrete piers as indicated or approved. Pipe saddles shall be shaped to fit the pipe with which they will be used and shall be capable of screw adjustment. Concrete piers shall conform accurately to the bottom one-third to one-half of the pipe. Piping along walls shall be supported by approved wall brackets with attached pipe rolls or saddles or by wall brackets with adjustable hanger rods. For piping supported from the ceiling, approved rod hangers of a type capable of screw adjustment after erection of the piping and with suitable adjustable concrete inserts or beam clamps shall be used. If required, piping supports shall be placed so as to provide a uniform slope in the pipe without sagging. Supports shall be located wherever necessary, and in no case shall they exceed 8 feet on centers for ductile iron pipe and 4 feet on centers for PVC pipe.

II.5.3. Casing spacers shall be a two piece prefabricated unit by a single manufacturer. All casing spacers in a single casing pipe crossing shall be by the same manufacturer. Casing spacers shall have a shell made from either 304 stainless steel, 14 gauge mild steel which has been heat fusion coated with PVC plastic, (PVC coating shall be .01 inch thick over the entire band including the runner studs) or high density polyethylene. Casing spacers on 16-inch and smaller carrier pipe shall have 8-inch wide steel bands and casing spacers on greater than 16-inch carrier pipe shall have 12-inch wide steel bands, except high density polyethylene spacers shall have high density polyethylene bands. All casing spacers for 12-inch and smaller pipe size shall have four 10 gauge or 14 gauge steel risers with runners and casing spacers for 16 inch and larger pipe shall have six 10 gauge or 14 gauge steel risers with runners (two top and four bottom), except high density polyethylene spacers shall have one riser for every diameter inch of carrier pipe. The runners (risers) shall be either glass reinforced plastic, UHMW polymer or high density polyethylene. All nuts, bolts and washers shall be 304 stainless steel. All risers over 2 inches in height shall be reinforced. Wooden skids are not an acceptable alternate.

### II.6. LOCATE WIRING

Locate wire shall be installed on all PVC, ductile iron and HDPE water main piping, and services 10 LF or greater in length. No wire shall be installed on above ground installations (must meet minimum installation requirements, see details). Locate wiring for direct bury shall be 12 gauge, copper wire with .03 inches (minimum) HDPE insulation thickness, .141 inches (minimum) O.D. Rated break load 250 lbs., 30 volt, 21% IACS, The outside color of the wire shall be blue.

### II.7. MATERIAL TESTING

JEA will perform random testing of all materials furnished for conformance to the following standards. The entire product of any manufacturer or of any one plant may be rejected when, in the opinion of JEA, the methods of manufacture fail to secure uniform results acceptable to the requirements of these specifications. Pipe and materials shall be tested in, and for conformity with, the latest editions of the following:

ITEM	SPECIFICATIONS
Ductile Iron Pipe and Fittings	ANSI A21.50 (AWWA C150)
	ANSI A21.51 (AWWA C151)
	ANSI A21.53 (AWWA C153)
	ANSI A21.40 (AWWA C104)
	ANSI A21.50 (AWWA C105)



# JEA Water and Wastewater Standards

## 350 Potable Water Piping

	ANSI A21.10 (AWWA C110)
	ANSI A21.15 (AWWA C115)
Polyvinyl Chloride Pipe and Fittings	ASTM D1598
	ASTM D1599
	ASTM D1784
	ASTM D1785
	ASTM D2122
	ASTM D2241
	ASTM D2564
	ASTM D2672
	ASTM D2837
	ASTM D2855
	ASTM D3139
	ASTM F477
	AWWA C900
	AWWA C905
	AWWA C907
Polyethylene Tubing	ASTM D1248
	ASTM D2239
	ASTM D2737
	ASTM D3350
	AWWA C901

### III. INSTALLATION

#### III.1. REFERENCE POINTS AND LAYOUT

The Contractor shall be responsible for setting all grade, lines and levels. The Contractor or Contractor's Surveyor will provide centerline of construction and will establish a bench mark. Any reference points, points of intersection, property corners, or bench marks, which are disturbed during construction, shall be restored by a Land Surveyor registered to practice in the State of Florida, and all costs thereof shall be borne by the Contractor. The Contractor shall assume all responsibility for the correctness of the grade and alignment stakes.

#### III.2. HANDLING AND CUTTING PIPE

Every care shall be taken in handling and laying pipe and fittings to avoid damaging the pipe, scratching or marring machined surfaces, and abrasion of the pipe coating. The lined pipe and fittings must be handled only from the outside of the pipe and fittings. No forks, chains, straps, hooks, etc. shall be placed inside the pipe and fittings for lifting, positioning, or laying. If damaged, the material shall be repaired in accordance with the liner manufacturer's recommendations. Any fitting showing a crack and any fitting or pipe which has received a severe blow that may have caused an incipient fracture, even though no such fracture can be seen, shall be marked as rejected and removed at once from the work. In any pipe showing a distinct crack in which it is believed there is no incipient fracture beyond the limits of the visible crack, the cracked

# *JEA Water and Wastewater Standards*

## *350 Potable Water Piping*

portion, if so approved by JEA, may be cut off before the pipe is laid so that the pipe used shall be perfectly sound. The cut shall be made in the sound barrel at a point at least 12 inches from the visible limits of the crack. Except as otherwise approved, all cutting shall be done with a power driven cut off saw. All cut ends shall be examined for possible cracks caused by cutting.

### **III.3. PIPE INSTALLATION**

#### **III.3.1. GENERAL REQUIREMENTS**

Water mains shall be constructed of the materials specified and as shown on the drawings. All PVC C900/C905 pipe shall be laid in accordance with AWWA C605. Pipe and fittings shall be carefully handled to avoid damage, and if feasible, while they are suspended over the trench before lowering, they shall be inspected for defects and to detect cracks. Defective, damaged or unsound pipe or fittings shall be rejected. Each section of the pipe shall rest upon the pipe bed for the full length of its barrel, with recesses excavated to accommodate bells and joints. Any pipe which has its grade or joint disturbed after laying shall be taken up and re-laid. Only suitable soils (no heavy clay) shall be utilized in the backfill operation up to 12 inches above the pipe. The maximum joint deflection shall be limited to 80% of the pipe manufacturer's recommendation. All precautions shall be taken to prevent sand or other foreign material from entering the pipe during installation. If necessary, a heavy, tightly woven canvas bag of suitable size shall be placed over each end of the pipe before lowering into the trench and left there until the connection is made to the adjacent pipe. Any time the pipe installation is not in progress, the open ends of pipe shall be closed by a watertight plug or other method approved by the Engineer. Plugs shall remain in pipe ends until all water is removed from the trench. Any sand or foreign material that enters the pipe shall be removed from the pipe immediately. No pipe shall be installed when trench conditions (standing water, excess mud, etc.) or the weather (rain, etc.) is unsuitable for such work, except by permission of the Engineer. Any section of pipe already laid which is found to be defective or damaged shall be replaced with new pipe. The contractor shall coordinate utility locates with Sunshine State One-Call of Florida, Inc. (# 811 or web site [www.callsunshine.com](http://www.callsunshine.com)), at a minimum. The use of 90 degree bends 24-inch and larger size shall be avoided if possible (two 45 degree bends or other method is preferred).

#### **III.3.2. SPECIAL CONSTRUCTION REQUIREMENTS FOR 20-INCH AND LARGER PIPE**

For pipe 20 inch and larger, unless approved otherwise by JEA, a foundation bed of granular material (57 stone) shall be placed under and around all ductile iron fittings and valves for additional support of heavy system components. A foundation bed of granular material shall be provided for all valves 20 inch size and larger. For granular materials, the minimum vertical limit is 12 inches under the fitting or valve, up to 1/3 the overall height of the fitting or valve. The minimum horizontal limits of the granular material shall be 12 inches in all directions beyond the outer edges of the fitting or valve. The compaction of soils below the granular material shall be at 98% of the maximum density. Payment for this work shall be included in the associated fitting or valve unit cost. Where possible, a full joint of pipe (no short pipe lengths) shall be connected to all fittings and valves. No joint deflection shall be allowed at the fittings or valves.

#### **III.3.3. PIPE COVER**

The cover over all piping less than 24-inch size shall be a minimum of 30 inches in unpaved areas and 36 inches in paved areas with a maximum of 60 inches, unless approved otherwise by JEA. The cover over all piping 24-inch size or greater shall be 36-inches (paved or unpaved areas), with a maximum of 84 inches, unless approved otherwise by JEA. Cover for pipe under pavement shall be measured from the finished grade. Any reduction in pipe cover will require approval from JEA

# JEA Water and Wastewater Standards

## 350 Potable Water Piping

and the Engineer. Greater depths will be permitted where required to miss obstructions only. Lines shall be located as shown on the drawings. The Contractor shall investigate well in advance of pipe laying any conflicts which may require readjustments in planned locations and advise the Engineer of the results of these investigations so that the Engineer may give instructions as to the modifications required. Refer to Chapter II. 3. - Section 408 for backfill and compaction requirements.

### III.3.4. INSTALLATION OF IRON PIPING

All iron pipe and fittings shall be laid in accordance with the pipe manufacturer's recommendations and the American Water Works Association Specification AWWA C600.

### III.3.5. THRUST RESTRAINT

All non-flanged fittings and valves shall be restrained using one of the following methods:

III.3.5.1. Mechanical restraint at fittings and valves and mechanical restraint along adjacent joints of pipe to a length as specified in the Restraint Joint Schedule (see Plate Nos. W-31A&B), at a minimum.

III.3.5.2. Mechanical joint fittings and valves shall be restrained using an approved restraining device and/or tie rods along adjacent joints of pipe to a length as specified. Tie Rods shall be ASTM A307 grade or equivalent (Fu=60 KSI, Ft=20KSI) Tie rods shall be as follows, at a minimum:

PIPE SIZE	NO. OF RODS	ROD SIZE
4	2	3/4
6	2	3/4
8	2	3/4
10	4	3/4
12	4	3/4
14	6	3/4
16	6	3/4
18	8	3/4
20	8	3/4
24	12	3/4
30	14	1
36	14	1
42	16	1 1/4
48	16	1 1/4
54	18	1 1/4

To connect tie rods to fitting, offset eyebolts shall be used. Tie rods shall be (core 10 steel or 316 S.S.), threaded as required, installed with a washer and nut (same material as the rod) on either side of the joint.

# ***JEA Water and Wastewater Standards***

## ***350 Potable Water Piping***

III.3.5.3. The use of thrust blocks shall be limited to situations such as point repair where exposing several joints of pipe is not feasible due to existing ground conditions and also must be used with mechanical joint restraining devices when, in the judgment of the Engineer, the nature and criticality of an installation is such as to require positive assurance of stability. Concrete collars with tie rods may be used on dead end lines at the Contractor's discretion. Concrete used for this purpose shall be 2,500 psi minimum. When applicable, schedule and details for the required thrust blocks are included on the drawings (see Plate No. W-38). The JEA Standard Details show minimum size thrust blocks for use in good soil. Poor soils will require larger thrust blocks.

### **III.3.6. JOINT RESTRAINTS WITHIN CARRIER PIPE**

All joints within steel casing pipe shall be restrained with mechanical restraining devices. End joints shall be tie rodded, with the ends of the rods welded to the end of the casing.

### **III.3.7. CASING SPACER INSTALLATION**

All carrier pipes in casings shall utilize casing spacers installed on the carrier pipe, inside the casing pipe. Casing spacers shall be installed one foot on both sides of each carrier pipe joint, and at ten feet intervals along the carrier pipe for pipe up to 48 inches. For carrier pipes larger than 48 inches, casing placement shall be as recommended by the casing spacer manufacturer. A casing spacer shall also be installed within two feet of each of the ends of the casing pipe.

## **III.4. REQUIRED PIPE SEPARATIONS**

III.4.1. It is required that "water mains" be installed, cleaned, disinfected and have a satisfactory bacteriological survey performed in accordance with the latest applicable AWWA Standards, Chapter 62-555, F.A.C. and latest JEA Water and Wastewater Standards. For the purpose of this section, the phrase "water mains" shall mean mains, including treatment plant process piping, conveying either raw, partially treated, or finished drinking water; fire hydrant leads; and service lines that have an inside diameter of three (3) inches or greater. In addition, the phrase "reclaimed water" refers to the water regulated under Part III of Chapter 62.610, F.A.C.

III.4.2. New or relocated, underground water mains shall be laid to provide a horizontal distance of at least three (3) feet between the outside of the water main and the outside of any existing or proposed storm wastewater, storm water force main, or pipeline conveying reclaimed water regulated under Part III of Chapter 62.610, F.A.C.

III.4.3. New or relocated, underground water mains shall be laid to provide a horizontal distance of at least six (6) feet, and preferably ten (10) feet, between the outside of the water main and the outside of any existing or proposed gravity or pressure-type sanitary wastewater or wastewater force main or pipeline conveying reclaimed water not regulated under Part III of Chapter 62.610, F.A.C. The minimum horizontal separation distance between water mains and gravity-type sanitary wastewaters may be reduced to three (3) feet where the bottom of the water main is laid at least six (6) inches above the top of the wastewater (special case).

III.4.4. New or relocated, underground water mains crossing any existing or proposed gravity or vacuum-type sanitary wastewater or storm wastewater shall be laid so the outside of the water main is at least six (6) inches, and preferable twelve (12) inches, above or at least twelve (12) inches below the outside of the other pipeline. However, it is preferable to lay the water main above the other

# JEA Water and Wastewater Standards

## 350 Potable Water Piping

pipeline. In locations where water mains cross under a box culvert or a 36 inch diameter and larger storm water main, JEA will Require DIP to be utilized for the water main.

- III.4.5. New or relocated, underground water mains crossing any existing or proposed pressure-type sanitary wastewater, wastewater or storm water force main, or pipeline conveying reclaimed water shall be laid so the outside of the water main is a least twelve (12) inches above or below the outside of the other pipeline. However, it is preferable to lay the water main above the other pipeline.
- III.4.6. At the utility crossings described in paragraphs (III.4.4.) and (III.4.5.) above, one full length of water main pipe shall be centered above or below the other pipeline so the water main joints will be as far as possible from the other pipeline. Alternatively, at such crossings, the pipes shall be arranged so that all water main joints are at least three (3) feet from all joints in vacuum-type sanitary wastewaters, storm wastewaters, storm water force mains, or pipelines conveying reclaimed water, and at least six (6) feet from all joints in gravity or pressure-type sanitary wastewaters or wastewater force mains or pipeline conveying reclaimed water.
- III.4.7. New or relocated fire hydrants shall be located so that the hydrants are at least three (3) feet from any existing or proposed storm wastewater, storm water force main, or pipeline conveying reclaimed water; at least three (3) feet, and preferably ten (10) feet, from any existing or proposed vacuum-type sanitary wastewater; at least six (6) feet, and preferably ten (10) feet, from any existing or proposed gravity or pressure-type sanitary wastewater or wastewater force main.
- III.4.8. Where an underground water main is being laid less than the required minimum horizontal distance from another pipeline and where an underground water main is crossing another pipeline and joints in the water main are being located less than the required minimum distance from joints in the other pipeline, the contractor shall consult the design engineer to obtain approval of any alternative construction methods, prior to construction.
- III.4.9. In no case shall a water main be routed through a manhole structure (storm or sanitary wastewater manholes) unless approved otherwise by a JEA manager.
- III.4.10. The table below provides the minimum horizontal separation requirements between the proposed utility and structures (see notes).

Pressure Main (water & wastewater) Nominal Size (inches)	Horizontal Separation Requirements (min) (See note 1)
up to 6"	10 feet
8"	14 feet
10"-12"	18 feet
16" and larger	See note 4
For gravity wastewater mains, see note 2.	

Notes:

- 1. The table above provides the minimum horizontal separation requirements between the proposed JEA maintained utilities (including water mains, reclaimed water mains, water service laterals, meter boxes and wastewater force mains) and existing, proposed and

# JEA Water and Wastewater Standards

## 350 Potable Water Piping

- future structures (including above ground structures, concrete footers and top of bank of ponds).
2. For gravity wastewater mains, the horizontal separation from existing, proposed and future structures (including above ground structures, concrete footers and top of bank of ponds) shall be a minimum of 3 times the vertical depth of the deepest portion of the manhole to manhole wastewater run.
  3. Pressure mains with pipe cover greater than 36 inches will require additional horizontal separation as reviewed and approved by JEA.
  4. Pressure mains 14 inch and larger will require additional horizontal separation as reviewed and approved by JEA.
  5. All depth measurements will be based upon final finished grade elevations, unless approved otherwise by JEA.

### III.4.11. SEPARATION FROM HARDWOOD TREES

III.4.11.1. The planting of hardwood trees (see listing below) within 36 inches (horizontal clearance) of the outside surface of the pressure main and the tree trunk or the installation of a pressure main within 36 inches (horizontal clearance) shall be prohibited. Service lines are excluded from this requirement. The planting of hardwood trees with a horizontal clearance between 3 and 6 feet or the installation of a pressure main between 3 and 6 feet from the outside surface of the tree trunk shall require root barrier material to isolate the main from future root growth. The root barrier (cut-off wall) shall be solid plastic or HDPE (0.0276" or 0.70 mm minimum thickness). The root barrier shall be installed/extended to all areas where the above clearances cannot be met. The root barrier shall extend vertically from the bottom of the pressure main to within 6 inches from top of finished grade, at a minimum.

III.4.11.2. NOTE: The list of hardwood trees include the following, at a minimum:

Acer Spp.	Liriodendron Tulipifera	Prunus Spp.
Bald Cypress	Loblolly Bay	Pyrus Calleryana
Betula Nigra	Magnolia Family	Quercus Leavis
Blackgum	Magnolia Spp.	Quercus Spp.
Bradford Pear	Maple Family	Quercus Stellata
Cherry Family	Nyssa Sylvatica	Red Cedar
Cupressocyparis Leylandii	Oak Family	River Birch
East Palatka/Savannah Holly	Palm Family	Salix Babylonia
Gordonia Lasianthus	Palmacea Spp.	Sweetgum
Juniperus Silicicola	Pine Family	Sycamore
Ilex Attenuata	Pinus Spp.	Taxodium Distichum
Leyland Cypress	Platanus Occidentalis	Tulip Poplar
Liquidambar Styraciflue	Post Oak	Turkey Oak
		Weeping Willow

### III.5. SYSTEM CONNECTIONS

# ***JEA Water and Wastewater Standards***

## ***350 Potable Water Piping***

All connections and ties to the JEA Water System and transfer of services will be performed by the contractor under supervision of the JEA's representative.

### **III.5.1. WATER MAIN CONNECTIONS**

Unless approved otherwise by JEA, tapped connections in the barrel of a pipe shall be less than the diameter of pipe being tapped except 4 inch pipe which may be tapped with a 4-inch tapping sleeve and valve. No taps (all sizes) shall be made within 5 pipe diameters or 5 feet (whichever is smaller) of a joint. When making 2-inch PVC water main connections to water mains, a 4" (minimum) gate valve shall be utilized with a 4" X 2", reducer connecting to the 2" main. No 2" gate valves (on the main) will be allowed.

### **III.5.2. WATER SERVICE CONNECTIONS**

All water service connections (new and taps into existing mains), shall have a no-lead brass corporation stop at the main and connected directly into the service saddle. No taps (all sizes) shall be made within 5 pipe diameters or 5 feet (whichever is smaller) of a joint.

## **IV. TESTING**

### **IV.1. SWABBING**

The purpose of swabbing a new pipeline is to conserve water while thoroughly cleaning the pipeline of all foreign material, sand, gravel, construction debris and other items not found in a clean system. Prior to pressure testing a pipeline swabbing shall be utilized. Swabbing details, Chapter VIII, Plates W-45, W-45A, W-45B, W-45C and W-45D.

- IV.1.1. New water, wastewater force, and reclaim mains greater than 12" (with exceptions to smaller pipe lines as deemed necessary by JEA) shall be hydraulically cleaned with a polypropylene swabbing device to remove dirt, sand and debris from main. JEA shall be the sole authority to determine when the pipe is clean and no more swabbing passes are required. A minimum of two swabbing passes through the pipe will be required. More swabbing passes may be required to achieve a clean pipe at the Contractor's expense.
- IV.1.2. If swabbing access and egress points are not provided in the design drawings, it will be the responsibility of the CONTRACTOR to provide temporary access and egress points for the cleaning, as required.
- IV.1.3. Passage of cleaning poly swabs through the system shall be constantly monitored, controlled and all poly swabs entered into the system shall be individually marked and identified so that the exiting of the poly swabs from the system can be confirmed.
- IV.1.4. Cleaning of the system shall be done in conjunction with, and prior to, the initial filling of the system for its hydrostatic test.
- IV.1.5. The Contractor shall insert flexible polyurethane foam swabs (two pounds per cubic foot density) complete with rear polyurethane drive seal, into the first section of pipe. The swabs shall remain there until the pipeline construction is completed. A JEA representative shall be present for the swabbing process including swab insertion and retrieval.
- IV.1.6. The line to be cleaned shall only be connected to the existing distribution system at a single connection point.

# *JEA Water and Wastewater Standards*

## *350 Potable Water Piping*

- IV.1.7. Locate and open all new in-line valves beyond the point of connection on the pipeline to be cleaned during the swabbing operation.
- IV.1.8. At the exit point for the poly swab, the Contractor is responsible for creating a safe environment for collection of debris, water and the swab. Considerations shall be made for protecting surrounding personnel and property and safe retrieval of the swab.
- IV.1.9. Only with JEA personnel on-site shall the supply valve from the existing distribution system be operated. Cleaning shall be accomplished by propelling the swab down the pipeline to the exit point with potable water. This shall continue until the water is completely clear and swab(s) is/are retrieved.
- IV.1.10. Re-apply a series of individual swabs in varying diameters and/or densities as required, to attain a clean pipe.
- IV.1.11. The contractor is responsible for providing and operating all pumps, gauges, hoses, piping, etc. to monitor the swab's progress and propel the swab through the pipe. System pressure may not be enough to propel the swab.
- IV.1.12. After the swabbing process, pressure testing and disinfection of the pipe shall be completed in accordance with this MANUAL.

### **IV.2. DISINFECTION TESTS**

- IV.2.1. All water pipe and fittings of whatever size and wherever installed on potable water lines shall be thoroughly disinfected prior to being placed in service. Disinfection shall follow the applicable provisions of the procedure established for the disinfection of water mains as set forth in AWWA Standard C651 entitled "AWWA Standard for Disinfecting Water Mains" and shall be in accordance with the procedure entitled "WATER SYSTEM CLEARANCES FOR JEA AND PRIVATELY-OWNED PUBLIC WATER SUPPLY SYSTEMS" which is found in the back of this specification. Dechlorination of flushing water may be required to be in compliance with the State of Florida Surface water Quality Standards (F.A.C. 62-302.530). Dechlorination is necessary if the flushing of highly chlorinated water is to be discharged directly to a surface water or to a stormwater system. If the water can be sheet flowed over a large area or discharged to a holding pond, dechlorination may be avoided.
- IV.2.2. The contractor shall prepare a written flushing plan which outlines water supply point and all blow-off points. Due to the limited water supply and operating limitations of the JEA system, the flushing plan must be approved by JEA, prior to implementation. The contractor shall modify the flushing plan as directed by JEA, at no additional cost. Temporary blow-offs, shall be installed for the purpose of clearing the water main. Blow-offs installed on water mains up to and including 12 inches shall be the same diameter as the water main. Unless approved otherwise by JEA, pipes shall be "flushed" at blow off points and at dead ends to achieve a minimum flow velocity of 3 FPS, and a minimum of 3 turn-overs of treated water shall be used in the flushing operation. Due to the many operating limitations of the existing water systems, the flushing operation will be scheduled (date and time), by JEA and will often require flushing during low water demand periods (10 p.m. to 5 a.m.). The contractor shall anticipate flushing lines during low water demand periods. The flushing operation shall continue until "clear" water samples are obtained at the discharge end of the line and is acceptable to JEA. Blow-offs installed on 16 inch water mains and larger shall be the next smaller size, in diameter, than the water main being tested. Temporary blow-offs shall be



# *JEA Water and Wastewater Standards*

## *350 Potable Water Piping*

removed and plugged after the main is cleared. The JEA Representative shall be present prior to and during the operation of blow-offs. The main shall be flushed prior to disinfection. The contractor shall be responsible for the proper disposal or discharge of the water during the flushing operation. The contractor shall be responsible (at no cost to the owner) for repairing all damages, due to the flushing operation.

- IV.2.3. The new water main shall be connected to the existing water main at one point only for flushing purposes (no looping). The new main **MUST** have a blow off on the end as required previously. After the new main is thoroughly flushed, the open end shall be sealed and restrained and the main shall be thoroughly disinfected. The contractor may use a separate source of water for flushing purposes. Upon completion of the flushing, the contractor shall proceed with disinfection as specified.
- IV.2.4. Anytime the new line is reopened, (to repair defective joints or pipe, defective fitting or valve), the complete disinfection process shall be repeated.
- IV.2.5. Bacteriological testing on the water main shall be scheduled and completed by JEA. JEA will collect the water samples and be responsible for completing the water analysis (lab testing).
- IV.2.6. Once bacteriological clearance (on 2 consecutive days of samples) has been approved, the main may be pressure tested against an existing system valve.
- IV.2.7. No new water main may be put in service until a Certification of Completion has been approved by the regulatory authority. The contractor must submit As-Builts, accurately depicting installed conditions as required for line clearances. The Contractor shall allow time for this process to be completed.

### **IV.3. PRESSURE AND LEAKAGE TESTS**

- IV.3.1. The Contractor shall test pipelines installed in accordance with these specifications prior to acceptance of the pipeline by JEA or connecting pipeline to any existing pipeline or facility. All field tests shall be made in the presence of a JEA representative. Except as otherwise directed, all pipelines shall be tested. Pressure testing of PVC and ductile iron pipe (including poly service piping), shall not include HDPE water main piping. Pressure testing of HDPE main piping shall be completed separately with no PVC or ductile iron pipe included in the HDPE test section. Testing of HDPE main piping is detailed in the specification section entitled, "Horizontal Directional Drilling", (Chapter VI. 2. – Section 750). Pipelines laid in excavation (other than trench excavation), shall be tested prior to the backfilling of the excavation. All piping to operate under liquid pressure shall be tested in sections of approved length. For these tests, the Contractor shall furnish clean water, suitable temporary testing plugs or caps, and other necessary equipment, and all labor required. If the Contractor chooses to pressure test against an existing JEA water main/valve, the new water main must be disinfected prior to connection to the JEA line. JEA will not be responsible for failure of the pressure test due to the existing valve leaking. If positive test results cannot be obtained because the JEA valves will not hold the test pressures, the Contractor shall be required to disconnect from the JEA System and re-test independent of the JEA System and at the Contractor's expense. JEA may elect to furnish suitable pressure gauges. If not, the contractor will provide the pressure gauges. The gauges shall be calibrated by an approved testing laboratory, with increments no greater than 2 psi and a 4 inch diameter face. Gauges used shall be of such size that pressures tested will not register less than 10% no more than 90% of the gauge capacity.

# *JEA Water and Wastewater Standards*

## *350 Potable Water Piping*

Leakage and pressure testing shall be in accordance with applicable AWWA C600 or AWWA C605 and as outlined below.

- IV.3.2. Unless it has already been done, the section of pipe to be tested shall be filled with water of approved quality and all air (or most of the air) shall be expelled from the pipe. Unlike water, entrapped air is compressible and is, therefore, very “explosive” and represents a very high risk of potential damage or even fatalities. If blow offs or other outlets are not available at high points for releasing air, the Contractor shall make the necessary taps at such points (12:00 position) and shall plug said holes after completion of the test. The table below is a convenient method to determine the approximate water addition that is required to raise the pressure in the test section from 0 psi to 150 psi with 0% air entrapment. Obviously, the test section will include some amount of air entrapment. The table below will indicate the severity of the amount of air entrapment in the test section. If the actual field test quantities (additional water amount) is over 4 times greater than the listed amounts, the test section may have severe air entrapment. In this case, the contractor should make additional effort to remove the entrapped air.
- IV.3.3. The table below lists the approximate amount of water which must be added to the pipe to raise the line pressure from 0 psi to 150 psi when no air is present in the pipe.

Pipe Diameter (inch)	Gallons/1000 L.F.
6	0.73
8	1.31
10	2.04
12	2.94
14	4.00
16	5.22
18	6.61
20	8.16
24	11.75
30	18.36
36	26.44
42	35.98

- IV.3.4. For mains larger than 20 inch size, it is highly recommended that the contractor profile (line and grade) the main after installation and prior to pressure and leakage test to accurately locate all high points. Field survey instrument (Level equipment) shall be utilized for this task. Blow off valves shall be installed (at a minimum) at all high points which offset vertically more than two pipe diameters in length (at a minimum). The contractor shall consult the design engineer on any technical questions or concerns.
- IV.3.5. Hydrostatic testing shall consist of a combined pressure test and leakage test. Specified test pressures, based on the elevation of the highest point of the line or section under test, and corrected to the elevation of the test gauge, shall be applied by means of a pump connected to

# *JEA Water and Wastewater Standards*

## *350 Potable Water Piping*

the pipe in a manner satisfactory to the Engineer. The pump, pipe connection and all necessary apparatus shall be furnished by the Contractor and shall be subject to the approval of the Engineer. All valved sections shall be hydrostatic tested to insure sealing (leak allowance) of all line valves.

- IV.3.6. All piping shall be pressure and leakage tested for a minimum of two hours duration at 150 psi minimum or 2 times operating pressure. Pressure tests shall be conducted simultaneously with the leakage test. During the 2 hour test, no pipe will be accepted if pressure loss is greater than 5 psi regardless of the leakage test results. All exposed pipe, fittings, valves and joints shall be examined carefully during the test. Any damaged or defective pipe, fittings or valves that are discovered following the pressure test shall be repaired or replaced with sound material and the test shall be repeated until it is satisfactory. Repairing, replacing and retesting shall be done at the Contractor's expense. For new installations, the contractor shall be limited to the number of repair couplings utilized to repair pipe joint leaks. Unless approved otherwise by JEA, the contractor is limited to two repair couplings (I.E., one joint leak) per 1,000 LF installed (same pipe size). Should the actual number of joint leaks exceed the above limit, then JEA may require the contractor to remove and re-install the entire associate main or certain sections of the main at the contractor's expense. For new work, "bell joint leak clamps" or similar devices are not acceptable for the repair of leaks at the joints.
- IV.3.7. Leakage tests shall be conducted simultaneously with the pressure tests. At the end of the pressure test, the line will be pumped back to initial test pressure. The quantity of water used to re-pump the line shall be measured and compared to the limitations calculated using the allowable leakage equations below.
- IV.3.7.1. Formula No. 1: may be used to determine an allowable leakage amount for PVC pipe, DIP or combination of both. If the actual leakage amount is equal or less than the allowable leakage amount (based upon Formula No. 1), the leakage test is acceptable (test passes and no other calculation are required). If the actual leakage amount is greater than the allowable leakage amount (based upon Formula No. 1), then the allowable leakage amount must be re-calculated based upon the sum total of Formula Nos. 2 and 3.
- IV.3.7.2. Formula No. 2: shall be utilized to determine the allowable leakage amount for the test section constructed with PVC pipe (based upon the number of rubber gaskets).
- IV.3.7.3. Formula No. 3: shall be utilized to determine the allowable leakage amount for the test section constructed with ductile iron pipe (based upon the total linear feet). For a test section, which includes both PVC and ductile iron pipe, the allowable leakage amount would be determined by adding the allowable leakage amount based upon Formula No. 2 (for the PVC pipe test section) and Formula No. 3 (for the DIP test section). No pipe installation will be accepted if the actual leakage amount (quantity of make-up water) is greater than the allowable leakage amount (based upon the sum total of Formula Nos. 2 and 3). These 3 formulas meet and exceed the requirements of AWWA C600 and AWWA C605. Pressure and Leakage Test forms for each of these 3 formulas are provided in the back of this section.

Formula No. 1: (PVC and DIP)       $L = \frac{SD \sqrt{P}}{148,000}$

# *JEA Water and Wastewater Standards*

## *350 Potable Water Piping*

$$\text{Formula No. 2: (PVC only)} \quad L = \frac{ND \sqrt{P}}{7,400}$$

$$\text{Formula No. 3: (DIP only)} \quad L = \frac{SD \sqrt{P}}{133,200}$$

$\sqrt{P} = 12.25$ , where  $P = 150$  psi

In which L is the allowable leakage amount in gallons per hour; S is the length of pipeline tested, in feet (5,000 L.F. max.); D is the nominal diameter of the pipe, in inches; P is the average test pressure during the leakage test, in pounds per square inch; and N is equal to the number of joints (rubber gaskets) in the PVC pipe test section. If test (based on Formula No. 2 and/or No. 3) discloses leakage greater than that specified above, the Contractor shall, at its own expense, locate and repair the defective material and retest until the leakage is within the specified allowance. The total length of pipe within the test section shall not exceed 5,000 linear feet, unless approved otherwise by JEA.

- IV.3.7.4. In the event a section fails to pass the tests, the Contractor shall do everything necessary to locate, uncover (even to the extent of uncovering the entire section), and replace the defective pipe, valve, fitting or joint. Visible leaks shall be corrected regardless of total leakage. Lines which fail to meet these tests shall be retested as necessary until test requirements are complied with. All testing shall be performed at the Contractor's expense.
- IV.3.7.5. If, in the judgment of JEA, it is impracticable to follow the foregoing procedures exactly for any reason, modifications in the procedure shall be made with approval; but, in any event, the Contractor shall be responsible for the ultimate tightness of the piping within the above requirement. Re-disinfection shall be required if the line is de-pressurized for repairs prior to tying into the JEA system.
- IV.3.7.6. HDPE: For leakage and pressure testing for high density polyethylene (HDPE, PE), Pipe and fittings, see "Horizontal Directional Drilling" (Chapter VI. 2. - Section 750), for technical specifications for testing HDPE products. Due to the expansion of HDPE pipe, the pressure testing of HDPE pipe sections must be tested separately from DIP and PVC pipe sections (see Chapter VI. 2. - Section 750 for clarification).

#### **IV.4. LOCATE WIRE**

##### **IV.4.1. LOCATE WIRE INSTALLATION**

Contractor shall furnish and install locate wiring on all water mains (both PVC and ductile iron) and on water services 10 LF or greater in length (see Detail W-44 for other locate wire requirements). Locate wire must be attached to water mains and services with duct tape or plastic ties at each side of bell joint or fitting and at 10 foot intervals along pipeline (at a minimum). Locate wire shall be brought to grade within a valve box or Locating Station box, as required, at 475 foot intervals (maximum), 2 foot of slack is required at each access point and locate wire box. Locate wire shall be installed in box and along pipeline as detailed in the JEA Standard Details. Locate wire shall be installed in either the 1:00 or 11:00 position on the pipe. Connection or splices underground which are not inside a locate box (or valve box), shall be prohibited. If an underground connection

# *JEA Water and Wastewater Standards*

## *350 Potable Water Piping*

is unavoidable, spliced tracer-wire joint shall be a waterproof connector, each connection shall be photograph showing a specific identification number (the station off-set location) written on each waterproof connector.

### **IV.4.2. LOCATE WIRE TESTING REQUIREMENTS**

Each installed locate wire within the JEA service area shall be tested by the contractor as part of the final inspection procedure, using an approved tester and approved testing equipment.

IV.4.2.1. Approved Tester: A person approved by JEA as proficient in the use of the equipment and; who has 12 months experience in the use of the equipment, including documented proof of past performance. The approved tester shall be listed on the JEA Responsible Bidder List (RBL) for, at minimum, work category GC11 - Line locate services / Wire testing.

IV.4.2.2. The contractor shall prepare the following:

- A set of project site drawings showing the stationing and offset for each locate wire box.
- A locate wire field testing schedule.

IV.4.2.3. The contractor shall submit the project site drawings and the field testing schedule to the JEA field representative (inspector) for approval. The JEA field representative may elect to be present during the testing period.

IV.4.2.4. The contractor shall provide the approved tester a copy of the project site drawings showing the stationing and offset for each locate wire box.

IV.4.2.5. The approved tester shall place a tone on the locate wire and trace the entire length of the installed wire, spot painting the location at least at 200-foot intervals along the route.

IV.4.2.6. The approved tester shall test the wire depth at 200-foot intervals.

IV.4.2.7. The approved tester shall report (show on project site drawings), where the pipe/wire has less than the allowable minimum cover or more than the maximum allowable cover (see Pipe Cover Section above for pipe cover limits). For pipe/wire which are installed within the acceptable cover limits, no remarks are required. All lateral stub-outs shall be marked and recorded.

IV.4.2.8. The approved tester shall prepare a Locate Wire Box checklist for each locate wire box.

IV.4.2.9. The approved tester shall prepare a final Locate Wire Report. The Locate Wire Report shall be submitted to the JEA field representative for review and approval. The report shall include the following:

- A signed statement from the approved tester certifying that all installed wire (where shown on the project site drawings), was successfully (sounded), traced with no open breaks.
- A copy of the project site drawings which indicate all field notes, breaks found/repaired, depths (if installed outside the acceptable cover limits), and other applicable field remarks by the approved tester.

# ***JEA Water and Wastewater Standards***

## ***350 Potable Water Piping***

IV.4.2.10. Copies of the Locate Wire Box checklist for each locate wire box shown on the project site drawings.

IV.4.2.11. A final Locate Wire Report shall be furnished prior to final acceptance of the project or as approved otherwise by JEA.

### **IV.5. INSPECTION**

All pipe and fittings shall be subject to inspection at time of delivery and also in the field just prior to installation. All pipe and fittings, which in the opinion of the Engineer do not conform to these specifications, will be rejected and shall be removed by the Contractor at the Contractor's expense. An authorized JEA representative must be present for all pressure and leakage testing, connections to JEA's existing lines, locate wire testing and the collection of water samples. The JEA representative will pull the water samples and deliver them to the lab.

### **IV.6. PERMIT REQUIREMENTS**

#### **IV.6.1. STATE HIGHWAY CROSSINGS**

Permits for all work within the right-of-way of a State Highway will be obtained by the Engineer. The Contractor shall, however, verify the existence of the permit before commencing work in this area. All work related to the State Highway crossing shall be in full compliance with the requirements of the Florida Department of Transportation permit and in accordance with the Florida Department of Transportation Utility Accommodation Guide and standard specifications. Unless otherwise shown on the drawings or specified herein, State Highway crossings shall be made by jacking a steel pipe casing, of the size shown on the drawings and shown in JEA Standard Details, under the highway at the elevations and locations shown. The water main shall then be placed in the casing with approved casing spacers as specified in this section. All joints within carrier pipe shall be mechanically restrained joints. After inspection, the ends of the casing shall be filled with 2500 psi concrete not less than 8-inches thick.

#### **IV.6.2. RAILROAD CROSSINGS**

Permits for all work within the railroad right-of-way will be obtained by the Engineer. The Contractor shall, however, verify existence of the permit before commencing work in this area. All work related to the railroad crossings shall be in full compliance with the terms of the permit and AREA Specifications for Pipeline Crossings Under Railway Tracks for Non-Flammable Substances. The water main shall be placed in steel casing pipe under all railroad crossings whether installed by open cutting or jacking and boring. The water main shall then be placed in the casing with approved casing spacers as specified in this section. All joints within carrier pipe shall be mechanically restrained joints. After inspection by the Engineer, the ends of the casing shall be sealed with 2,500 psi concrete not less than 12 inches thick. Upon completion and prior to final acceptance, the Contractor shall place crossing markers of a type acceptable to the Railroad Company at each end of the crossing at the railroad right-of-way.

#### **IV.6.3. PLAN APPROVAL AND CONSTRUCTION SUPERVISION**

IV.6.3.1. All plans and specifications for construction of each public water supply project must be prepared by an engineer registered in the State of Florida. Prior to construction, the plans and specifications together with FDEP Form 62-555.900(1) or 62-555.900(7). Application for a Specific Permit to Construct PWS Components or, Notice of Intent to Use the General Permit for Construction of Water Main Extensions for PWSs must be

# ***JEA Water and Wastewater Standards***

## ***350 Potable Water Piping***

approved by the Florida Department of Environmental Protection or approved through the JEA Self-Permitting program. Systems which are 12 inches in diameter or less within Duval County can be eligible for the self-permitting program. Refer to [www.jea.com](http://www.jea.com) for more details.

IV.6.3.2. "The provisos for approval for each project are included on each application form. Attention is called to item ii "statement by the applicant" which requires a professional engineer registered in the State of Florida to inspect construction of the project for the purpose of determining if work proceeds in compliance with the construction permit and approved engineering plans and specifications. This engineer will be responsible for filing the Certificate of Completion for the project."

IV.6.3.3. It is required that "Water Supply Facilities" including mains and permitted service connections shall be installed, cleaned, disinfected and have a satisfactory bacteriological survey performed in accordance with the latest applicable AWWA Standards and Chapter 62-555, Florida Administrative Code. After project construction, flushing, disinfection and bacteriological sampling, a properly completed "Certificate of Construction Completion and Request for a Letter of Clearance to Place a Public Drinking Water Facility into Service" DEP Form 62-555.900(9) shall be submitted along with bacteriological survey results, and signed "as built" or "record" drawings to the Florida Department of Environmental Protection. A letter of clearance must be obtained from the Florida Department of Environmental Protection before the project is placed into service for any purpose other than disinfection, testing for leaks, or testing equipment operation. (Record or as built drawings must include elevations or separations at all crossings and parallel runs of water mains with sanitary wastewaters, storm wastewaters, and reclaimed water lines.)

## **V. WATER SERVICES**

### **V.1. NEW WATER SERVICES**

New Water services shall be furnished and installed in the sizes and location indicated on the Contract documents. Short side services shall be services installed on the same side of the road as the water main. Long side services shall be services installed on the opposite side of the road as the water main. Long side services shall be installed by boring as indicated on the drawings or as directed by JEA. Boring may be accomplished by any method approved by JEA except that no water jetting shall be allowed. Long side services may be installed by open cut method only if the entire roadway is reconstructed or approved otherwise by JEA.

### **V.2. RENEWAL AND TRANSFER OF WATER SERVICE**

#### **V.2.1. GENERAL**

Where a new water main is installed or where an existing water main is relocated or replaced, as shown on the drawings or where necessary due to a direct conflict with proposed construction and when approved by the engineer, the contractor shall install new service piping from the water main to each existing or new water meter. The lateral and meter shall be the same size. A renewal and transfer of water service shall include saddle, corp stop, service tubing, curb stop, no-lead brass adapter and meter coupling.

#### **V.2.2. SPECIAL CONSTRUCTION CONNECTING INTO EXISTING 5/8" METERS**

# *JEA Water and Wastewater Standards*

## *350 Potable Water Piping*

New water services which connect to an existing 5/8" x 5/8" water meter shall be constructed to allow for the future installation of a 3/4" water meter. Specifically for new k water services which connect to an existing 5/8" x 5/8" water meter, the following no-lead brass materials shall be utilized (at a minimum): 1" curb stop, 1" x 3/4" no-lead brass bushing, 3/4" meter coupling (hex on barrel type), no-lead brass adapter to change 3/4" meter to 5/8" meter spud size and then connection into 5/8" existing meter. The cost to construct this connection shall be included in the unit price bid amount for new or replacement of water service.

### V.2.3. SERVICE LINE SIZE

If shown on the drawings, a double one (1) inch water service line is acceptable for long side services utilizing 2 inch poly main per construction detail W-1. Gang water services (5 or more services in one area) is acceptable for long side services if shown on the drawings and constructed in accordance with construction detail W-1. Service lines and component parts thereof shall be sized based on the meter size as follows:

Meter Size	Tap, Corp Stop, Curb Stop and Pipe Size
1" and smaller	1"
1-1/2"	1-1/2"
2"	2"
3"	4"
4"	4"
6"	6"
8"	8"
10"	10"
12"	12"

## VI. RESPONSIBILITY FOR WELL AND MAIN CLEARANCES

It is expected that the engineer of record shall have responsibility for supervising the flushing, disinfection and bacteriological sampling of all wells, treatment plans and distribution systems prior to clearance by the Florida Department of Environmental Protection. The Contractor shall obtain prior approval from the engineer of record of the procedure to be used for flushing and disinfection of the completed work.

### VI.1. JEA OWNED WATER SYSTEMS

Sampling shall be done by JEA in the case of mains being connected to the JEA distribution systems. Contractor shall notify JEA to schedule sampling activities.

### VI.2. PRIVATELY OWNED WATER SYSTEMS

Private utility companies are responsible for proper performance of main clearance/release procedures. Upon completion of procedures in accordance with AWWA Standards (AWWA C651 and Chapter 62-555 of the Florida Administrative Code), the Contractor for private water utilities shall make arrangements with the Environmental Engineering Section of the Florida Department of Environmental Protection. Questions concerning the proper clearance/release procedures shall be directed to the Florida Department of Environmental Protection or other approved regulatory agency.



# *JEA Water and Wastewater Standards*

## *350 Potable Water Piping*

### **VI.3. DISINFECTION OF WELLS AND WATER MAINS**

- VI.3.1. Bacteriological sample points shall be installed every 1,000 feet (maximum) and at deadends and stub outs greater than 40 linear feet, at a minimum.
- VI.3.2. Reference: AWWA C651 and AWWA C654. Basic Principles: (#1) Prevention of contamination during construction or repair is of primary importance. Before disinfection procedures are commenced, well and mains shall be thoroughly flushed to remove contamination materials from the line. Section 4 of the AWWA procedure outlines precautions during construction and instructions for preliminary flushing. (#2) Disinfection is accomplished by introducing chlorine into the main to be sanitized. Either chlorine gas (liquid chlorine in cylinders) or hypochlorites may be used.
- VI.3.3. Chapter 62-555.315(3) of the Florida Administrative Code and AWWA Standard C654 specify the procedures which shall be used for disinfection and clearance of wells, while Section 62-555.340 of the Florida Administrative Code and AWWA Standards C651, C652 and C653 give the procedures for disinfection standards in general. Liquid chlorine comes in 150 pound or ton cylinders. Great care must be exercised in its use under the personal supervision of a person familiar with its properties and toxicity. Hypochlorites are chemical compounds of chlorine. Commonly used are Calcium Hypochlorites, 5.25 to 16% chlorine by weight. Hypochlorites are best applied by preparing a solution and injecting it into the system in accordance with the procedures contained in Section 5 of the AWWA procedure. Concentration within the main shall be not less than 25 mg/l at the beginning of the required 24-hour holding period and shall not be less than 10 mg/l at the end of the holding period. Procedure shall ensure contact with all parts of the system.
- VI.3.4. The "slug method" as outlined in Section 5.3 of the AWWA procedure employs 100 mg/l of chlorine for 3 hours with the chlorine remaining above 50 mg/l at the end of 3 hours.
- VI.3.5. Final Flushing: After normal 24 hours contact time or the shorter contact time authorized when "slug method" is used, the heavily chlorinated water shall be flushed from the main until residual within the line reaches the level of chlorine normally carried in the distribution system - maximum 1.0 mg/l.
- VI.3.6. Dechlorination of flushing water may be required to be in compliance with the State of Florida Surface water Quality Standards (F.A.C. 62-302.530). Dechlorination is necessary if the flushing of highly chlorinated water is to be discharged directly to a surface water or to a stormwater system. If the water can be sheet flowed over a large area or discharge to a holding pond, dechlorination may be avoided.

### **VI.4. BACTERIAL EXAMINATION**

#### **VI.4.1. WATER MAINS**

Upon completion of water main flushing, samples shall be submitted until satisfactory results are obtained on two (2) successive working days. Great care must be exercised in sampling because if the initial disinfection fails to produce satisfactory results, disinfection must be repeated and samples resubmitted. As outlined above, arrangements shall be made with JEA and the JEA Water Quality Lab for all collection of bacteriological samples from systems to be connected to JEA systems and for sampling of privately owned systems. Samples shall be collected in sterile bottles or bags, treated with sodium thiosulfate to neutralize chlorine residual. It is important that the

# *JEA Water and Wastewater Standards*

## *350 Potable Water Piping*

chlorine residual (maximum 4.0 ppm allowed) and pH of the line (main) be taken and recorded in columns (3) and (4) of the Department of Health Form DH 655-1/97 (if the Department of Health Lab is not used for analysis then the lab's substitution form must have the same format). Hoses are not satisfactory sampling points. A suggested sampling tap consists of a standard corporation cock installed in the main with tube goose-neck assembly which may be removed after use or retained for future use as a sampling point. Samples shall be taken at all dead ends and at intervals of no greater than 1000 feet on continuous pipe runs. All permitted service stubs (domestic, irrigation or fire) shall be sampled at the meter location or the backflow location. Bacteriological test results shall be considered unacceptable if the tests were completed more than 60 days before the Department received the results.

### **VI.4.2. WELLS**

Section 62-555.315 of the Florida Administrative Code requires that after thorough pumping of the well to remove the disinfecting agent, a series of 20 or more consecutive daily samples shall be submitted for laboratory examination. No more than two samples, at least 6 hours apart shall be collected per day. In extenuating circumstances, the number of samples may be reduced upon approval of the Florida Department of Environmental Engineering. In Jacksonville (Duval County) the Florida Environmental Department of Environmental Protection will make this determination on the basis of the nature of the aquifer, depth of well, type of construction, location and other pertinent facts. The same arrangements outlined above for clearance of water mains should be followed for wells.

## **VII. INSPECTION CHECKLISTS AND REPORTS**

# JEA Water and Wastewater Standards

## 350 Potable Water Piping

### VII.1. RECORD OF PRESSURE AND LEAKAGE TEST BASED ON FORMULA NO. 1 (PVC AND DIP MATERIAL)

PROJECT: \_\_\_\_\_

TEST SECTION: \_\_\_\_\_

JEA REPRESENTATIVE: \_\_\_\_\_ SIGNATURE \_\_\_\_\_

TEST DATE: \_\_\_/\_\_\_/\_\_\_ TEST TIME: \_\_\_\_\_ BEGIN \_\_\_\_\_ END \_\_\_\_\_

OTHER TEST PHASE ATTENDEE'S:

\_\_\_\_\_  
\_\_\_\_\_

Pressure and Leakage Test Calculations: \_\_\_\_\_ WATER MAIN \_\_\_\_\_ WASTEWATER FORCE MAIN  
\_\_\_\_\_ RECLAIMED WATER MAIN

Line Pressure Test:

Start: \_\_\_\_\_ PSI (Minimum of 150 PSI or 2x operating pressure) End: \_\_\_\_\_ PSI

Difference: \_\_\_\_\_ PSI (IF GREATER THAN 5 PSI, THE TEST FAILS)

TYPE OF PIPE PVC/D.I.P. (1)	DIAMETER OF PIPE (INCHES) (2)	LINEAR FEET (3)	2-HOUR TEST FACTOR (4)	TOTAL ALLOWABLE LEAKAGE (2x3x4) (5)
			0.0001655	
			0.0001655	
			0.0001655	
			0.0001655	
			0.0001655	
<b>Total Allowable Leakage Amount (Gallons):</b>				

Allowable Leakage Amount \_\_\_\_\_ Gal \_\_\_\_\_ Oz. (32 oz per qt; 128 oz per gal)

Actual Leakage Amount \_\_\_\_\_ Gal \_\_\_\_\_ Oz.

Pressure and Leakage Test Results (Pass or Fail:) \_\_\_\_\_

The above is based on the average pressure test of 150 PSI, 2 hour test period and utilizing Formula No. 1 as given below ("L" is the allowable leakage amount in gallons per hour, "S" is the length of pipe tested (5,000 L.F. max.); "D" is the diameter of the pipe and "P" is the average test pressure):

$$\frac{\text{FORMULA NO. 1}}{(\text{PVC AND D.I.P.})} \quad L = \quad \frac{SD P^{1/2}}{148,000}$$

Formula No. 1 may be used to determine an allowable leakage amount for PVC Pipe, DIP or combination of both. If the actual leakage amount is equal or less than the allowable leakage amount (based upon Formula No. 1), the leakage test is acceptable (test passes and no other calculation is required). If the actual leakage amount is greater than the allowable leakage amount (based upon Formula No. 1), the allowable leakage amount must be re-calculated based upon the sum total of Formula Nos. 2 and 3 (see other forms for these calculations). The above formula meets and exceeds the requirements of AWWA C600 and AWWA C605. The total length of pipe within the test section shall not exceed 5,000 linear feet, unless approved otherwise by JEA.

FILE No. \_\_\_\_\_

Revised January 1, 2014

# JEA Water and Wastewater Standards

## 350 Potable Water Piping

### VII.2. RECORD OF PRESSURE AND LEAKAGE TEST BASED ON FORMULA NO. 2 (PVC MATERIAL ONLY)

PROJECT: \_\_\_\_\_

TEST SECTION: \_\_\_\_\_

JEA REPRESENTATIVE: \_\_\_\_\_ SIGNATURE \_\_\_\_\_

TEST DATE: \_\_\_/\_\_\_/\_\_\_ TEST TIME: \_\_\_\_\_ BEGIN \_\_\_\_\_ END \_\_\_\_\_

OTHER TEST PHASE ATTENDEES:

\_\_\_\_\_

Pressure and Leakage Test Calculations: \_\_\_\_\_ WATER MAIN \_\_\_\_\_ WASTEWATER FORCE MAIN

\_\_\_\_\_ RECLAIMED WATER MAIN

Line Pressure Test:

Start: \_\_\_\_\_ PSI (Minimum of 150 PSI or 2x operating pressure) End: \_\_\_\_\_ PSI

Difference: \_\_\_\_\_ PSI (IF GREATER THAN 5 PSI, THE TEST FAILS)

TYPE OF PIPE PVC (1)	DIAMETER OF PIPE (INCHES) (2)	NUMBER OF JOINTS (3)	2-HOUR TEST FACTOR (4)	TOTAL ALLOWABLE LEAKAGE (2x3x4) (5)
PVC			0.00331	
PVC			0.00331	
PVC			0.00331	
PVC			0.00331	
PVC			0.00331	

PVC (Sum of Above):	
D.I.P.(From Formula 3:	
Total Allowable:	

Allowable Leakage Amount \_\_\_\_\_ Gal \_\_\_\_\_ Oz . (32 oz per qt; 128 oz per gal)

Actual Leakage Amount \_\_\_\_\_ Gal \_\_\_\_\_ Oz.

Pressure and Leakage Test Results (Pass or Fail): \_\_\_\_\_

The above is based on the average pressure test of 150 PSI, 2 hour test period and utilizing Formula No. 2 as given below ("L" is the allowable leakage amount in gallons per hour, "N" is the number of joints (rubber gaskets) in the test section; "D" is the diameter of the pipe and "P" is the average test pressure):

$$\frac{\text{FORMULA NO. 2}}{\text{(PVC ONLY)}} \quad L = \quad \frac{ND P^{1/2}}{7,400}$$

Formula No. 2 may be used to determine an allowable leakage amount for PVC Pipe only. If the actual leakage amount is equal or less than the allowable leakage amount (based upon Formula No. 2), the leakage test is acceptable (test passes). If the actual leakage amount is greater than the allowable leakage amount (based upon Formula No. 2), the leakage test fails. For a test section, which includes both PVC and ductile iron pipe, the allowable leakage amount would be determined by adding the allowable leakage amount based upon Formula No.2 (for the PVC pipe test section) and Formula No. 3 (for the DIP test section). The above formula meets and exceeds the requirements of AWWA C600 and AWWA C605. The total length of pipe within the test section shall not exceed 5,000 linear feet, unless approved otherwise by JEA.

FILE No. \_\_\_\_\_

Revised January 1, 2014

# JEA Water and Wastewater Standards

## 350 Potable Water Piping

### VII.3. RECORD OF PRESSURE AND LEAKAGE TEST BASED ON FORMULA NO. 3 (DIP MATERIAL ONLY)

PROJECT: \_\_\_\_\_

TEST SECTION: \_\_\_\_\_

JEA REPRESENTATIVE: \_\_\_\_\_ SIGNATURE \_\_\_\_\_

TEST DATE: \_\_\_/\_\_\_/\_\_\_ TEST TIME: \_\_\_\_\_ BEGIN \_\_\_\_\_ END \_\_\_\_\_

OTHER TEST PHASE ATTENDEES:  
 \_\_\_\_\_  
 \_\_\_\_\_

Pressure and Leakage Test Calculations: \_\_\_\_\_ WATER MAIN \_\_\_\_\_ WASTEWATER FORCE MAIN  
 \_\_\_\_\_ RECLAIMED WATER MAIN

Line Pressure Test:  
 Start: \_\_\_\_\_ PSI (Minimum of 150 PSI or 2x operating pressure) End: \_\_\_\_\_ PSI  
 Difference: \_\_\_\_\_ PSI (IF GREATER THAN 5 PSI, THE TEST FAILS)

TYPE OF PIPE PVC/D.I.P. (1)	DIAMETER OF PIPE (INCHES) (2)	LINEAR FEET (3)	2-HOUR TEST FACTOR (4)	TOTAL ALLOWABLE LEAKAGE (2x3x4) (5)
D.I.P.			0.0001839	
D.I.P.			0.0001839	
D.I.P.			0.0001839	
D.I.P.			0.0001839	
D.I.P.			0.0001839	

D.I.P. (Sum of Above):	
PVC (From Formula 2):	
Total Allowable:	

Allowable Leakage Amount \_\_\_\_\_ Gal \_\_\_\_\_ Oz. (32 oz per qt; 128 oz per gal)  
 Actual Leakage Amount \_\_\_\_\_ Gal \_\_\_\_\_ Oz.  
 Pressure and Leakage Test Results (Pass or Fail:) \_\_\_\_\_

The above is based on the average pressure test of 150 PSI, 2 hour test period and utilizing Formula No. 3 as given below ("L" is the allowable leakage amount in gallons per hour, "S" is the length of pipe tested (5,000 L.F. max.); "D" is the diameter of the pipe and "P" is the average test pressure):

$$\text{FORMULA NO. 3} \quad L = \frac{SD P^{1/2}}{133,200}$$

(D.I.P. ONLY)

Formula No. 3 may be used to determine an allowable leakage amount for D.I.P. Pipe only. If the actual leakage amount is equal or less than the allowable leakage amount (based upon Formula No. 3), the leakage test is acceptable (test passes). If the actual leakage amount is greater than the allowable leakage amount (based upon Formula No. 3), the leakage test fails. For a test section, which includes both PVC and ductile iron pipe, the allowable leakage amount would be determined by adding the allowable leakage amount based upon Formula No.2 (for the PVC pipe test section) and Formula No. 3 (for the DIP test section). The above formula meets and exceeds the requirements of AWWA C600 and AWWA C605. The total length of pipe within the test section shall not exceed 5,000 linear feet, unless approved otherwise by JEA.

FILE No. \_\_\_\_\_ Revised January 1, 2014

# JEA Water and Wastewater Standards

## 350 Potable Water Piping

### VII.4. TRACER WIRE CERTIFICATION FORM

Project Name: \_\_\_\_\_

Availability Number: \_\_\_\_\_ Project Number: \_\_\_\_\_ Date/Time: \_\_\_\_\_

Service:  Potable Water  
 Reclaimed Water  
 Wastewater

Continuity/Signal strength between access points:			Marker Balls Installed / Located (Check)			
Access pt #1 to access pt #2:			Installed		Located	
Access pt #2 to access pt #3:			Installed		Located	
Access pt #3 to access pt #4:			Installed		Located	
Access pt #4 to access pt #5:			Installed		Located	
Access pt #5 to access pt #6:			Installed		Located	
Access pt #6 to access pt #7:			Installed		Located	
Access pt #7 to access pt #8:			Installed		Located	
Access pt #8 to access pt #9:			Installed		Located	
Access pt #9 to access pt #10:			Installed		Located	

	Water	Sewer / FM	Reclaimed Water	Fiber Optic
Total footage tested				

If any faults found List below (please indicate utility type and location)	
Fault # 1:	
Fault # 2:	
Fault # 3:	
Fault # 4:	

Comments: \_\_\_\_\_

# *JEA Water and Wastewater Standards*

## *350 Potable Water Piping*

Name of Tester:

\_\_\_\_\_  
Signature & Printed Name

Testing Company:

\_\_\_\_\_  
Printed Name

Contractor Representative:

\_\_\_\_\_  
Signature & Printed Name

Installation Contractor:

\_\_\_\_\_  
Printed Name

JEA Inspector:

\_\_\_\_\_  
Signature & Printed Name

JEA O&M representative:

\_\_\_\_\_  
Signature & Printed Name

Commissioned this date:

\_\_\_\_\_  
Signature & Printed Name

Locate Wire Test Results

Pass

Fail

*Blank Page*





## **351 - WATER METERS, VALVES, HYDRANTS AND APPURTENANCES**

### **I. GENERAL REQUIREMENTS**

#### **I.1. SCOPE OF WORK**

The Contractor shall furnish, install and test all gate valves, check valves and other special valves and appurtenances as shown on the drawings and herein specified. All references to Industry Standards (ASTM, ANSI, AWWA, etc.) shall be to the latest revision unless otherwise stated. Only those materials included in the JEA Water and Wastewater Standards Manual shall be installed. All materials shall be new unless specifically called for otherwise and shall adhere to the 2014 EPA standards for lead free brass. If not approved otherwise by JEA, the typical valve spacing shall be 1000 (maximum) feet intervals within residential areas and 500 (maximum) feet intervals within industrial and commercial areas. If possible, gate valves shall be installed nearest a TEE or CROSS fitting (exceptions may include work within DOT right-of-way and work outside of Duval County). The contractor shall field check all exposed bolts on all valves to insure that they are tight prior to installation. All water meters shall be installed by JEA.

#### **I.2. SHOP DRAWING SUBMITTALS**

Actual catalog data, brochures and descriptive literature will not be required for items of standard usage, which meet the requirements of Chapter X. and Chapter XI. of the JEA Water and Wastewater Standards Manual. Any specialty item not shown in this manual will require a complete shop drawing submittal. The Engineer may at any time require the Contractor to provide a complete detailed shop drawing submittal for any material, which may, in the Engineer's opinion, not be in compliance with the JEA Water and Wastewater Standards.

#### **I.3. LOCATING MARKERS FOR VALVES & VACANT LOT SERVICES**

##### **I.3.1. VALVE MARKERS**

A 'V' cut shall be carved in the curb/asphalt closest/adjacent to a below grade valve. This 'V' cut shall be painted blue. Water services serving vacant lots (service not in use), shall include a "W" cut in the curb (closest to the meter box), and painted blue.

##### **I.3.2. MARKER BALLS**

A blue water marker ball shall be installed on all buried valves. Marker ball shall be as shown on Plate W-18 of the Water & Reclaim Construction Details.

#### **I.4. WARRANTY**

The Contractor shall provide to JEA a two (2) year unconditional warranty after substantial project completion or acceptance or any designated portion thereof. The warranty shall include materials and installation and shall constitute complete replacement and delivery to the site of materials and installation of same to replace defective materials or defective workmanship with new materials/workmanship conforming to the specifications.

#### **I.5. INSPECTION CHECKLISTS**

# ***JEA Water and Wastewater Standards***

## ***351 Water Meters, Valves, Hydrants, and Appurtenances***

Contractor shall schedule a final walk-through (prior to substantial completion) in order to create a punch list for each project. List of attendees shall include but not be limited to the Contractor's representative, JEA representative (ie. project inspector), and designated JEA Operation personnel. Contractor shall be required to provide a crew complete with all necessary equipment to allow observation/operation of each new and rehabilitated fire hydrant, meter box and valve. The Contractor's representative shall complete the associated JEA Final Inspection Checklist for each new or rehabilitated fire hydrant, meter box and valve, and have the JEA attendees provide original signatures/names on the signature block. The JEA representative shall scan the checklists and ensure the documents are filed in the electronic file folder for the project.

## **II. WATER METERS**

### **II.1. WATER METERS 5/8" THRU 1"**

#### **II.1.1. ELECTROMAGNETIC FLUID OSCILLATOR METERS**

The following specification shall apply to JEA 5/8", 5/8"x3/4", 3/4" and 1" electromagnetic of fluid oscillator technology, Type Cold Potable Water Meters. Meters furnished under these specifications shall be capable of measuring cold water flow by means of electromagnetic of fluid oscillator technology with no moving parts and shall be equipped with a field programmable, tamperproof and hermetically sealed electronic register with LCD display.

- II.1.1.1. Electromagnetic of fluid oscillator technology type cold potable water meters shall be manufactured in accordance with the latest revision of the NSF/ANSI Standard-61 Annex F and G, American Water Works Association Standard C700, C710, C713. With particular reference to flow capacity, pressure loss, accuracy, physical dimensions, design, and material of construction.
- II.1.1.2. Meters shall be compliant with JEA's current Automated Meter Reading System and Automated Meter Reading Transmitter.
- II.1.1.3. The meters shall be new, unused and the most current production model at the time of the procurement.
- II.1.1.4. All meter registers shall be tamper proof or tamper resistant.
- II.1.1.5. Meters shall be touch-read capable and registers shall be equipped with a pit lid style touch pad to plug into the current Automated Meter Reading Transmitter.
- II.1.1.6. The outer surface of the meter main case shall be permanently marked with meter serial number, size, model, and direction of flow.
- II.1.1.7. The meter main case shall have the manufacturer's serial number marked/etched upon the register lid and on top of the main case. The serial number shall be 8-digits and indicate or otherwise represent the date of manufacture.
- II.1.1.8. A 2-D bar code representing the 8-digit serial number shall be permanently and clearly marked/etched/labeled on the register face under the glass and be able to be read by barcode scanning devices.

# *JEA Water and Wastewater Standards*

## *351 Water Meters, Valves, Hydrants, and Appurtenances*

- II.1.1.9. The 5/8" to 1" size meters shall have a male pipe thread connection with dimensions as indicated in AWWA C700-9.
- II.1.1.10. The meter register shall be constructed of heat tempered glass, permanently hermetically sealed meeting the IP-68 requirements and tamper resistant with sufficient strength and hardness to resist destructive force and scratching. The register housing shall be constructed and equipped with a hinged lid, which shall be recessed or designed to overlap the register to protect the reading area. The register lid shall be securely attached to the register housing. Fogging shall not occur during the warranty period. Glass registers must be designed to prohibit water and mud from collecting over reading area.
- II.1.1.11. All meters shall register in US gallons and must be clearly marked.
- II.1.1.12. The meter shall be supplied with a straight reading odometer-type indicator that contains a minimum of nine (9) number digits. Eight (8) number digits shall be electronically activated to read into the current JEA Automated Meter Reading System starting at the one gallon increment. The number digits reading less than one (1) US gallon shall not be electronically activated.
- II.1.1.13. Meters shall have the ability to log and store data for a period no less than thirty (30) days at an hourly interval and must be able to have data extracted while meter is in service by field personnel.
- II.1.1.14. Meter register shall include a direction of flow indicator registering both forward and reverse flow.
- II.1.1.15. Meters shall pass JEA's current bench testing standard operating procedure in accordance with AWWA C-700 accuracy standards for new water meters.
- II.1.1.16. Reclaimed meters shall be supplied with a pantone 522C colored reclaimed package consisting of a pantone 522C color faced register stating "No Drink" in English and Spanish with the international no drink logo. The main case shall have a permanent stamp also stating "No Drink".
- II.1.1.17. All meters shall be accompanied with a tag attached to the meter including documentation of actual manufacturer test results to include high, medium and low flow test results for each individual water meter, a 2-D bar code representing the 8-digit serial number, manufacture date, manufacturer's part number and meter description at the time of delivery. Manufacturer shall be responsible for the delivery of all meters in a first class condition. Inspection and testing of meters shall be made by JEA at the time of delivery. Any shipments failing to pass such inspection and/ or tests shall be returned to the manufacturer and replaced by the manufacturer, all at no cost to JEA.
- II.1.1.18. In the event that a particular meter model, register or any part thereof is discontinued or superseded, a sample of the alternative or successor model shall be submitted to JEA for testing and evaluation prior to approval and a bid award as an acceptable alternate meter model, register or any part thereof.

### II.1.2. ELECTROMAGNETIC METER WARRANTY

# ***JEA Water and Wastewater Standards***

## ***351 Water Meters, Valves, Hydrants, and Appurtenances***

The following minimum warranty shall be required for meter sizes 5/8" thru 1" and shall be in addition to the manufacturer's standard warranty.

- II.1.2.1. The sealed register shall be guaranteed against defects in materials, battery life and workmanship from the date of acceptance by JEA for a period not less than twenty (20) years. All registers failing during this period shall be replaced at absolutely no cost to JEA for the first ten (10) years and pro-rated thereafter.
- II.1.2.2. The manufacturer shall warranty that all meters will perform to American Water Works Association (AWWA) new meter accuracy standards for a period of twenty (20) years from date of acceptance by JEA from the manufacturer. The meter shall be considered not performing as warranted if it fails to pass JEA's current bench testing standard operating procedure in accordance with AWWA C-700 accuracy standards for new water meters.
- II.1.2.3. All meters that do not meet these accuracy requirements shall be returned to the manufacturer at their expense and shall be replaced with new meters.

### **II.1.3. BRASS POSITIVE DISPLACEMENT METERS**

The following specification shall apply to JEA 5/8", 5/8"x3/4", 3/4" and 1" Positive Displacement Type Cold Potable Water Meters.

- II.1.3.1. Brass positive displacement type cold potable water meters shall be manufactured in accordance with the latest revision of the American National Standards Institute/American Water Works Association C700 Standard. With particular reference to flow capacity, pressure loss, accuracy, physical dimensions, design, and material of construction.
- II.1.3.2. Meters shall be compliant with JEA's current Automated Meter Reading System and Automated Meter Reading Transmitter.
- II.1.3.3. The meters shall be new, unused, and the most current production model at the time of the procurement.
- II.1.3.4. All meter registers shall be tamper proof or tamper resistant.
- II.1.3.5. Meters shall be touch-read capable and registers shall be equipped with a pit lid style touch pad to plug into the current Automated Meter Reading Transmitter.
- II.1.3.6. The outer surface of the meter main case shall be permanently marked with meter serial number, size, model, and direction of flow.
- II.1.3.7. The meter main case shall have the manufacturer's serial number marked/etched upon the register lid and on top of the main case. The serial number shall be 8-digits and indicate or otherwise represent the date of manufacture.
- II.1.3.8. A 2-D bar code representing the 8-digit serial number shall be permanently and clearly marked/etched/labeled on the register face under the glass and be able to be read by barcode scanning devices.

# *JEA Water and Wastewater Standards*

## *351 Water Meters, Valves, Hydrants, and Appurtenances*

- II.1.3.9. The 5/8" to 1" size meters shall have a male pipe thread connection with dimensions as indicated in AWWA C700-9.
- II.1.3.10. The meter register shall be constructed of heat tempered glass, permanently hermetically sealed meeting the IP-68 requirements and tamper resistant with sufficient strength and hardness to resist destructive force and scratching. The register housing shall be constructed and equipped with a hinged lid, which shall be recessed or designed to overlap the register to protect the reading area. The register lid shall be securely attached to the register housing. Fogging shall not occur during the warranty period. Glass registers must be designed to prohibit water and mud from collecting over reading area.
- II.1.3.11. All meters shall register in US gallons and must be clearly marked.
- II.1.3.12. The meter shall be supplied with a straight reading odometer-type indicator that contains a minimum of nine (9) number digits. Eight (8) number digits shall be electronically activated to read into the current JEA Automated Meter Reading System starting at the one gallon increment. The number digits reading less than one (1) US gallon shall not be electronically activated. No change gears shall be allowed for accuracy calibration.
- II.1.3.13. Meter register shall include a direction of flow indicator registering both forward and reverse flow.
- II.1.3.14. Meters shall pass JEA's current bench testing standard operating procedure in accordance with AWWA C-700 accuracy standards for new water meters.
- II.1.3.15. Reclaimed meters shall be supplied with a pantone 522C colored reclaimed package consisting of a pantone 522C color faced register stating "No Drink" in English and Spanish with the international no drink logo. The main case shall have a permanent stamp also stating "No Drink".
- II.1.3.16. All meters shall be accompanied with a tag attached to the meter including documentation of actual manufacturer test results to include high, medium and low flow test results for each individual water meter, a 2-D bar code representing the 8-digit serial number, manufacture date, manufacturer's part number and meter description at the time of delivery. Manufacturer shall be responsible for the delivery of all meters in a first class condition. Inspection and testing of meters will be made by JEA at the time of delivery. Any shipments failing to pass such inspection and/ or tests shall be returned to the manufacturer and replaced by the manufacturer, all at no cost to JEA.
- II.1.3.17. In the event that a particular meter model, register or any part thereof is discontinued or superseded, a sample of the alternative or successor model shall be submitted to JEA for testing and evaluation prior to approval and a bid award as an acceptable alternate meter model, register or any part thereof.
- II.1.3.18. The meter main case shall be made of an American Water Works Association C700 bronze casting composition standard material meeting the 2014 EPA standards for lead free brass, with a bolted split case arrangement and bottom plate that meets

# ***JEA Water and Wastewater Standards***

## ***351 Water Meters, Valves, Hydrants, and Appurtenances***

American Water Works Association C700 4.1 and 4.2 non-breakable standards with stainless steel bolt fasteners.

II.1.3.19. All meters shall be the nutating disc or oscillating piston type with the measuring chamber manufactured with a nickel mix bronze (consisting of a minimum of 19% and a maximum of 21.5% nickel), tinned bronze or a corrosion resistant thermoplastic material.

### **II.1.4. POSITIVE DISPLACEMENT METER WARRANTY**

The following minimum warranty shall be required for meter sizes 5/8" thru 1" and shall be in addition to the manufacturer's standard warranty.

II.1.4.1. The sealed register shall be guaranteed against defects in materials and workmanship from the date of acceptance by JEA for a period not less than ten (10) years. All registers failing during this period shall be replaced at absolutely no cost to JEA. The manufacturer shall warranty that all meters will perform to American Water Works Association (AWWA) new meter accuracy standards for a period of fifteen (15) years or 1.5 million gallons from date of acceptance by JEA from the manufacturer. The meter shall be considered not performing as warranted if it fails to pass JEA's current bench testing standard operating procedure in accordance with AWWA C-700 accuracy standards for new water meters.

II.1.4.2. All meters that do not meet these accuracy requirements shall be returned to the manufacturer at their expense and shall be replaced with new meters.

## **II.2. WATER METERS 3" AND LARGER**

These Specifications set forth the JEA design criteria and performance requirements for Commercial Rated Domestic, Fire-Rated and Reclaimed Water Type Cold Water Meters. These meters will be utilized in commercial and industrial applications for water measurement and critical billing where a wide flow range is anticipated. JEA is requiring meters that shall meet or exceed all the requirements of ANSI/AWWA Standard C701 for Class II Turbine, C702 for Compound and C703 for Fire-Rated Water meter assemblies. Meters purchased in accordance with this specification shall be designed, manufactured and tested to meet performance capabilities of continuous operation from low flow up to the rated maximum flows without affecting the meters long-term accuracy or causing any undue component wear.

### **II.2.1. Commercial Domestic Rated Water Meters**

The meters required per this specification shall be the 3", 4" and 6" sizes.

- 3" Potable Compound
- 3" Potable Turbine
- 4" Potable Compound
- 4" Potable Turbine
- 6" Potable Compound
- 6" Potable Turbine

II.2.2. The meter main case shall meet the 2014 lead free standards, consisting of brass, stainless steel or single ductile iron composition with a fusion-bonded epoxy coating which adheres to NSF (National Science Foundation) for non-lead regulation compliance.

# *JEA Water and Wastewater Standards*

## *351 Water Meters, Valves, Hydrants, and Appurtenances*

II.2.3. Meters shall be supplied with an integral strainer and a test port, both accessible from the top of the meter.

II.2.4. The Strainer's screen shall have a minimum net open area of at least two (2) times the pipe opening and be a V-shaped configuration for the purpose of maintaining a full unobstructed flow pattern. The strainer body shall be identical to that of the meter's main case. All fasteners shall be stainless steel capable of maintaining the following static pressure ratings and physical dimensions:

METER SIZE	MAXIMUM OPERATING PRESSURE	CENTERLINE TO STRAINER BASE	OVERALL LENGTH (NOT TO EXCEED)
3"	200 psig	4-1/8 inches	17 inches
4"	200 psig	4-3/4 inches	20 inches
6"	200 psig	5-3/4 inches	24 inches

II.2.5. Meters purchased in accordance with this specification shall meet or exceed all requirements of ANSI/AWWA Standard C701 and C702 for Class II compound meter lay lengths and turbine meter assemblies. Each meter assembly shall be factory performance tested prior to shipment to ensure standard compliance.

II.2.6. Meter assemblies shall be manufactured to operate properly without leakage, damage, or malfunction up to a maximum working pressure of 200 pounds per square inch (psig).

II.2.7. All meters shall have low flow measuring capabilities per the meter operating characteristics requirement chart listed below to accurately measure consumption for billing and water conservation.

II.2.8. The meter assemblies shall have performance capability of continuous operation up to the rated maximum flows as listed below without affecting long-term accuracy or causing any undue component wear. The meter assembly shall also provide a 25% flow capacity in excess of the maximum flows listed for intermittent flow demands. Maximum head-loss through the meter / strainer assembly shall not exceed those listed in the following table per each meter size:

Meter operating characteristics requirements:

Meter Size	Low flow (95% Min.)	Operating Range (98.5 - 101.5%)	Intermittent Flows	Pressure Loss (Not to Exceed)
3"	0.5 gpm	1.0 to 400 gpm	500 gpm	3.2 psi @ 400 gpm
4"	0.75 gpm	1.5 to 800 gpm	1000 gpm	6.4 psi @ 800 gpm
6"	1.5 gpm	3.0 to 1600 gpm	2000 gpm	5.5 psi @ 1600 gpm

II.2.9. The 3", 4" and 6" meter assemblies shall have flanges of the Class 125 round type, flat faced and shall conform to ANSI B16.1 for specified diameter, drilling and thickness.

II.2.10. The meters shall be equipped with all-electronic register and no mechanical gearing.

The electronic register shall include the following list of features:

- AMR resolution units fully programmable



# *JEA Water and Wastewater Standards*

## *351 Water Meters, Valves, Hydrants, and Appurtenances*

- Pulse output frequency fully programmable
  - Display of total consumption
  - Integral data logging capability for at least thirty one days
  - Integral resettable accuracy testing feature
  - Large, easy-to-read LCD display
  - 10-year battery life guarantee
- II.2.11. All meters shall have a direct magnetic drive between the motion of the measuring element blade position and the electronic register. Any and all additional intermediate, magnetic or mechanical drive couplings shall not be acceptable.
- II.2.12. The meter register shall read 8 numbers and have Touch-read (TR) proven interface. The meter shall also have the capabilities to connect with a plug and play type touch couple connection to the JEA's current Automated Meter Reading System and Automated Meter Reading Transmitter.
- II.2.13. The meters shall be supplied with a straightening vane assembly that is positioned directly upstream of the measuring element. The straightening vane shall be an integral component of the measuring chamber.
- II.2.14. All meter packages shall display the sizes, model, manufacturer name, and direction of flow. Such displays shall also be cast on the side of the meter main case.
- II.2.15. Meters shall be guaranteed against defects in material and workmanship for a period of one (1) year from date of shipment.
- II.2.16. All meters received by JEA will be tested. Any meter that does not meet this specification will be rejected.

### **II.3. COMMERCIAL FIRE-RATED WATER METERS**

These Specifications set forth the JEA design criteria and performance requirements for Fire-Rated Water Meters. These water meters shall be Combination Dual Fire Service Type, consisting of two (2) Class II turbine type meters, a ductile iron strainer assembly and a weighted detector check valve. This meter assembly is intended for use where an extremely wide flow range is required and where measurement of both domestic and fire service water usage is essential. The meter assembly package shall comply with the latest ANSI/AWWA Standard C-703. Meters purchased in accordance with this specification shall be designed, manufactured and tested to meet performance capabilities of continuous operation from low flow up to the rated maximum flows without affecting the meters long-term accuracy or causing any undue component wear.

- II.3.1. The Commercial Fire-Rated meters required per this specification shall be the 4", 6", 8" and 10" sizes.
- 4" Potable/Fire
  - 6" Potable/Fire
  - 8" Potable/Fire
  - 10" Potable/Fire

# *JEA Water and Wastewater Standards*

## *351 Water Meters, Valves, Hydrants, and Appurtenances*

II.3.2. Each Fire-Rated meter assembly shall have a separate UL (Underwriters' Laboratories) listed and FM (Factory Mutual Research) approved external fire service strainer as a part of the meter package. The strainer's screen shall have a minimum net open area of at least four (4) times the pipe opening and be a V-shaped stainless steel screen for the purpose of maintaining a full unobstructed flow pattern. The strainer body shall be coated ductile iron with stainless steel fasteners capable of maintaining the following static pressure ratings as listed in the table below.

II.3.3. The maximum overall length of the unit as listed below shall be the face-to-face dimensions:

METER SIZE	PRESSURE TEST RATING	CENTERLINE TO STRAINER BASE	OVERALL LENGTH (NOT TO EXCEED)
4"	350 psig	4-1/2 inches	33 inches
6"	350 psig	5-3/4 inches	45 inches
8"	350 psig	6-3/4 inches	53 inches
10"	350 psig	8-1/2 inches	68 inches

II.3.4. The bypass assembly piping size shall be 1-1/2" for 4" and 2" for 6", 8" and 10" sizes. The assembly piping shall be bronze with threaded connections. The assembly shall also consist of an 1-1/2" or 2" turbine meter with flanged connections, one (1) bronze body check valve downstream of the meter and two (2) bronze lockable ball valves one located upstream and one located downstream of the meter to be used as isolation valves. The detector check valve operation shall be considered critical to the overall performance of the meter assembly. The detector check valve shall be positioned directly downstream of the mainline turbine type.

II.3.5. The meter main case shall meet the 2014 lead free standards, consisting of brass, stainless steel or single ductile iron composition with a fusion-bonded epoxy coating which adheres to NSF (National Science Foundation) for non-lead regulation compliance.

II.3.6. The flange size, model and direction of flow shall be cast in raised characters on both sides of the main case. Straightening vanes shall be assembled in both meter main cases.

II.3.7. The measuring chambers shall consist of a measuring element, calibration device and register. The measuring element shall be mounted on a horizontal, stationary, stainless steel shaft with sleeve bearings and be essentially weightless in water. The measuring chamber shall be capable of operating within accuracy limits without calibration when transferred from one main case to another of the same size

II.3.8. All reduction gearing shall be enclosed in the permanently hermetically sealed register. The drive magnet shall be located in the measuring element, and the follower magnet shall be located inside the permanently hermetically sealed register. An intermediate magnetically active material shall be required to distribute the magnetic flux uniformly to the follower magnet, thereby improving service life, low flow sensitivity, extended flow capacity and overall accuracy of the entire combination meter assembly.

II.3.9. The standard totalizing register shall have a stainless steel cup and tempered glass lens. The register shall be permanently hermetically sealed; all registers of similar size and registration shall have a standard gear ratio reduction so as to permit complete register interchangeability. The

# *JEA Water and Wastewater Standards*

## *351 Water Meters, Valves, Hydrants, and Appurtenances*

register shall be assembled to the measuring chamber in a tamperproof manner so removal can be made only after the measuring chamber is removed from the main case. Sweep-hand reading and odometer wheel details shall conform to American Water Works Standard C-701. A low flow indicator shall be included in the register assembly and be visible on top of the register's dial face.

- II.3.10. The meters shall operate properly without leakage, damage or malfunction up to a maximum pressure of 175 pounds per square inch (psig).
- II.3.11. All meters, 4" to 10" sizes, must have internal straightening vanes installed and retained firmly in the inlet portion of the main case to maximize meter performance and accuracy.
- II.3.12. Fire-Rated meters shall be supplied with a built in test port.
- II.3.13. Each Fire-Rated meter shall be shipped to JEA fully assembled and ready to install.
- II.3.14. The meter register shall read 8 numbers, read in gallons and have Touch-read (TR) proven interface. The meter shall also have the capabilities to connect with a plug and play type touch couple connection to the JEA's Landis and Gyr meter transmitting unit.
- II.3.15. Meter assemblies shall have performance capabilities of continuous operation up to the rated maximum flows as listed below without affecting long-term accuracy or causing any undue component wear. All meter assemblies shall also have a 25% flow capacity in excess of the maximum flows listed for intermittent flow demands. In addition, the meter assemblies shall be capable of measuring a minimum of 90% of actual water consumption at prescribed crossover flow rates. Maximum head loss through the meter assemblies shall not exceed those listed in the following table based on meter size.

METER SIZE	CONTINUOUS FLOWS	INTERMITTENT FLOWS	LOW FLOWS
4"	4 to 1000 gpm	1250 gpm	3 gpm
6"	4 to 2000 gpm	2500 gpm	3 gpm
8"	4 to 3500 gpm	4400 gpm	3 gpm
10"	4 to 5500 gpm	7000 gpm	3 gpm

METER SIZE	ACCURACY @ CROSSOVER (APPROX.)	HEADLOSS (NOT TO EXCEED)	N/A
4"	90% @ 30 gpm	8.5 psi @ 1000 gpm	N/A
6"	90% @ 50 gpm	9.4 psi @ 2000 gpm	N/A
8"	90% @ 50 gpm	13.4 psi @ 3500 gpm	N/A
10"	90% @ 60 gpm	12.5 psi @ 5500 gpm	N/A

#### II.4. COMMERCIAL RECLAIMED RATED WATER METERS

These specifications set forth the JEA design criteria and performance requirements for Turbine-type cold water meters. These meters shall be utilized in commercial and industrial applications for Reclaimed Water

# *JEA Water and Wastewater Standards*

## *351 Water Meters, Valves, Hydrants, and Appurtenances*

Measurement and critical billing where a wide flow range is anticipated. The meter package shall meet or exceed all requirements of ANSI/AWWA Standard C701 for Class II turbine meter assemblies. Each meter assembly shall be performance tested to ensure compliance. Meters purchased in accordance with this specification shall be designed, manufactured and tested to meet performance capabilities of continuous operation from low flow up to the rated maximum flows without affecting the meters long-term accuracy or causing any undue component wear.

- II.4.1. The meters required per this specification shall be 1-1/2", 2", 3", 4" and 6" sizes.
- 1.5" Reclaim
  - 2" Reclaim
  - 3" Reclaim
  - 4" Reclaim
  - 6" Reclaim
- II.4.2. The meter main case shall meet the 2014 lead free standards, consisting of brass, stainless steel or single ductile iron composition with a fusion-bonded epoxy coating which adheres to NSF (National Science Foundation) for non-lead regulation compliance.
- II.4.3. The meter assembly shall operate properly without leakage, damage, or malfunction up to a maximum working pressure of 200 pounds per square inch (psi).
- II.4.4. The meter's register shall be all-electronic and shall not contain any mechanical gearing to display flow and accurate totalization.
- II.4.5. The electronic register shall include the following partial list of features:
- AMR (Automatic Meter Reading) resolution units fully programmable
  - Pulse output frequency fully programmable
  - Display total consumption
  - Integral data logging capability for at least thirty one days
  - Integral resettable accuracy testing feature
  - Large, easy-to-read LCD display
  - 10-year battery life guarantee
- II.4.6. Any and all additional intermediate, magnetic or mechanical drive couplings are not acceptable.
- II.4.7. Registers shall be 8-digits and colored pantone purple.
- II.4.8. A straightening vane assembly is mandatory and shall be positioned directly upstream of the measuring element. The straightening vane assembly shall be an integral component of the measuring chamber. Flanges for the 1-1/2" and 2" size meter assemblies shall be of the 2-bolt oval flange configuration. The 3", 4", and 6" size meter assemblies shall have flanges of the Class 125 round type, flat faced and shall conform to ANSI B16.1 for specified diameter, drilling and thickness.
- II.4.9. All sizes of meter packages shall display the sizes, model, manufacturer name, and direction of flow. Such display shall be cast on the side of the meter maincase. Meters shall be guaranteed

# *JEA Water and Wastewater Standards*

## *351 Water Meters, Valves, Hydrants, and Appurtenances*

against defects in material and workmanship for a period of one (1) year from date of shipment. In addition, the meter supplier shall submit nationally published literature clearly outlining its factory maintenance program and current price schedule covering complete measuring chamber exchange.

- II.4.10. The meter strainer shall be integral and cast as a part of the main case. The strainer's screen shall have a minimum net open area of at least two (2) times the pipe opening and be a V-shaped configuration for the purpose of maintaining a full unobstructed flow pattern. The strainer body shall be a coated ductile iron fusion-bonded epoxy identical to that of the meter's main case. All fasteners shall be stainless steel capable of maintaining the following static pressure ratings and physical dimensions:

METER SIZE	MAXIMUM OPERATING PRESSURE	CENTERLINE TO STRAINER BASE	OVERALL LENGTH (NOT TO EXCEED)
1-1/2"	200 psig	2-5/16 inches	13 inches
2"	200 psig	2-5/16 inches	17 inches
3"	200 psig	4-1/8 inches	19 inches
4"	200 psig	4-3/4 inches	23 inches
6"	200 psig	5-3/4 inches	27 inches

**II.4.11. 1-1/2"-2" RECLAIMED METERS**

II.4.11.1. Reclaimed Meters shall be supplied with the 2-bolt oval flange configuration for installation purposes.

II.4.11.2. The meter register shall read 8 numbers and have Touch-read (TR) proven interface. The meter shall also have the capabilities to connect with a plug and play type touch couple connection to the JEA's current Automated Meter Reading System and Automated Meter Reading Transmitter.

II.4.11.3. The meter assembly shall have performance capability of continuous operation up to the rated maximum flows as listed below without affecting long-term accuracy or causing any undue component wear. The meter assembly shall also provide a 25% flow capacity in excess of the maximum flows listed for intermittent flow demands. Maximum head loss through the meter/strainer assembly shall not exceed those listed in the following table per meter size

Meter operating characteristics requirements:

METER SIZE	LOW FLOW (95% MIN.)	OPERATING RANGE (98.5 - 101.5%)	INTERMITTENT FLOWS	PRESSURE LOSS (NOT TO EXCEED)
1-1/2"	.75 gpm	1.25 to 160 gpm	200 gpm	6.9 psi @ 160 gpm
2"	1.0 gpm	1.5 to 200 gpm	250 gpm	7.0 psi @ 200 gpm

**II.4.12. 3"-6" RECLAIMED METERS**

II.4.12.1. Shall have flanged ends with a built-in test port for installation purposes.

# *JEA Water and Wastewater Standards*

## *351 Water Meters, Valves, Hydrants, and Appurtenances*

II.4.12.2. The meter register shall read 8 numbers and have Touch-read (TR) proven interface. The meter shall also have the capabilities to connect with a plug and play type touch couple connection to the JEA's current Automated Meter Reading System and Automated Meter Reading Transmitter.

II.4.12.3. The meter assembly shall have performance capability of continuous operation up to the rated maximum flows as listed below without affecting long-term accuracy or causing any undue component wear. The meter assembly shall also provide a 25% flow capacity in excess of the maximum flows listed for intermittent flow demands. Maximum head loss through the meter/strainer assembly shall not exceed those listed in the following table per meter size.

Meter operating characteristics requirements:

METER SIZE	LOW FLOW (95% MIN.)	OPERATING RANGE (98.5 - 101.5%)	INTERMITTENT FLOWS	PRESSURE LOSS (NOT TO EXCEED)
3"	1.5 gpm	2.5 to 500 gpm	650 gpm	5.1 psi @ 500 gpm
4"	2.0 gpm	3.0 to 1000 gpm	1250 gpm	8.7 psi @ 1000 gpm
6"	2.5 gpm	4.0 to 2000 gpm	2500 gpm	8.2 psi @ 2000 gpm

### II.5. AUTOMATED METER READING TRANSMITTER

- II.5.1. Radio read devices shall communicate, operate and be approved by Landis and Gyr. Meter transmitting units shall be designed for pit set installation of the dual port type so they may be touch-read compatible as well as send a radio read.
- II.5.2. Radio read devices shall be labeled with its Lan ID No, version in series, date manufactured and barcode.
- II.5.3. The components of the radio read device shall be contained in waterproof housings with no openings.
- II.5.4. The connection from the meter register to the meter transmitting unit shall be a plug and play touch couple connection.
- II.5.5. The device shall be made to fit a JEA approved water meter box and cover with 2" holes, see plate W-3 of the JEA Water and Wastewater Standards Manual.
- II.5.6. The radio read device shall be no larger than 4.43" W x 5.09" H x 4.6" D and be detachable. Any updates that are done to the programming shall first be tested with the current and past meters to confirm its compatibility.
- II.5.7. The warranty on the Meter Transmission Unit or Radio Frequency Water device shall be guaranteed against defects in materials and workmanship from the date of acceptance by JEA for a period not less than ten (10) years. All failing units during this period shall be replaced at absolutely no cost to JEA.

### III. VALVES

# *JEA Water and Wastewater Standards*

## *351 Water Meters, Valves, Hydrants, and Appurtenances*

### **III.1. GATE VALVES**

#### **III.1.1. GENERAL**

Isolation gate valves shall be provided at water main branches in two directions on a tee and in three directions on a cross. Isolation gate valves shall be provided on water mains at a maximum of 500-foot intervals within high density residential, commercial or industrial developments, at a maximum of 1000-foot intervals within residential areas, and at a maximum of 2500-foot intervals on transmission mains with a limited number of service connections. Isolation gate valves shall be provided on water main stub outs for future connections. Gate valves shall be designed for 250 psi minimum working pressure. When full open, gate valves shall have a clear waterway equal to the nominal diameter of the pipe. The operating nut or wheel shall have an arrow cast in the metal indicating the direction of opening. Each valve shall have the manufacturer's distinctive marking, pressure rating and year of manufacture cast on the body. Prior to shipment from the factory, each valve shall be tested by applying to it a hydraulic pressure equal to 500 psi (twice the specified working pressure).

#### **III.1.2. BURIED VALVES**

Buried gate valves shall be iron body bronze mounted, all exterior mounted bolts and nuts shall be stainless steel, rubber or EDPM encapsulated, resilient seat, solid wedge, non-rising stem type with operating nuts and adjustable valve boxes and covers. Operating nuts shall be two inches square. Resilient seat or wedge type gate valves shall conform to applicable sections of AWWA Standards C509 (250 psi) or C-515. All gate valves 24-inches or larger must be geared for horizontal (bevel) or vertical (spur) installations. All valves 20-inch and smaller shall be installed vertically unless additional depth of bury is impossible due to physical obstructions. Valves 24-inch and larger may be installed vertically or horizontally (see construction plans).

#### **III.1.3. ABOVE GROUND VALVES**

Gate valves located above ground or inside structures shall be hand wheel operated, non-rising stem type with flanged ends and be of the same general construction as buried valves.

#### **III.1.4. VALVE JOINTS**

All gate valves shall have mechanical joint ends, flanged ends, or screw joints to fit the pipe run in which they are used, except valves installed on push-on joint pipe shall have mechanical joint ends unless otherwise specified.

#### **III.1.5. ROTATION OF OPENING**

All valves shall open by turning to the left or counter clockwise, when viewed from the stem.

#### **III.1.6. EXTENSION STEMS**

Where extension stems are required, substantial, adjustable wall brackets and extension stems shall be furnished and located as directed. Extension stems shall be provided on all buried valves when the operating nut is deeper than 30 inches below the final grade. Sufficient stem extension shall be provided so that the nut will be no more than 30 inches below finished grade.

### **III.2. CHECK VALVES**

Check valves shall conform to the requirements of AWWA C508. Check valves larger than 2-inch nominal size shall be iron body with stainless steel bolts and nuts, flanged ends, outside lever, spring loaded (stainless steel spring if available), swing-type with straight-away passageway of full pipe area. The valve

# *JEA Water and Wastewater Standards*

## *351 Water Meters, Valves, Hydrants, and Appurtenances*

shall have renewable bronze seat ring and rubber-faced disc. Check valves larger than 2 inches shall be 150 psi working pressure. Check valves 2 inches and smaller nominal size shall be all brass swing check valves, 200 psi working pressure. Buried check valves shall be installed in an access box with traffic rated cover.

### **III.3. PAINTING OF VALVES AND VALVE BOX LIDS**

The top side of all water valve box covers and the inside of the top section of the valve box shall be painted blue except for gate valves at fire hydrants. The top of valve box covers and the inside of the top section of the valve box at fire hydrants shall be painted yellow. Oil based, traffic-rated paint shall be used. Privately owned and maintained fire hydrants and valves/valve box lids shall be painted red unless approved otherwise by the local fire marshal.

### **III.4. HYDROSTATIC AND LEAKAGE TEST**

The Contractor shall be required to perform a separate hydrostatic/leakage field test on each valve installed to insure it is bubble tight. The duration of this test shall be 15 minutes at 150 psi and conform to AWWA C504. The method of performing this test shall be left up to Contractor with the Engineer's approval. The failure of the valve to perform will result in its removal from the job site and replacement by the Contractor at the contractor's expense.

## **IV. MISCELLANEOUS VALVES AND APPURTENANCES**

### **IV.1. TAPPING SLEEVES**

To be utilized only for live tap applications or where specifically approved by JEA. No taps (all sizes) shall be made within 5 feet of a fitting, joint or tap. Unless approved otherwise by JEA, size-on-size taps are limited on PVC mains to 12-inch size and smaller. Size-on-size taps are acceptable on D.I.P. (all sizes). For size-on-size taps, on 8" and larger mains, the actual taphole size shall be reduced by 1-inch.

#### **IV.1.1. CAST IRON, MECHANICAL JOINT**

Cast iron mechanical joint tapping sleeves shall be rated for 200 psi minimum for 4-inch through 12-inch and 150 psi minimum for sizes 14-inch through 24-inch and shall conform to ASTM A126. In lieu of a ductile tee fitting, a tapping sleeve may be utilized on 24-inch and larger D.I.P. for outlets 12-inch and smaller. Tapping flange conforming to ANSI B16.1, Class 125 with MSS SP-60. Tapping sleeves 8-inch and smaller may have outlet connection to fit a mechanical joint tapping valve. This sleeve shall not be utilized on PVC pipe larger than 12-inch.

#### **IV.1.2. STAINLESS STEEL**

Stainless steel tapping sleeves may be used on 4-inch pipe and larger. Stainless steel tapping sleeves shall be all 304 stainless steel, including flanges, bolts and nuts and shall be rated for 150 psi minimum operating pressure and 200 psi minimum test pressure. The tapping sleeve shall have a pilot flange recessed for tapping per MSS SP-60. The pilot flange shall be pressure rated Class D according to AWWA C207 with 125 pound drilling conforming to ANSI B16. Each sleeve shall be supplied with a flanged gasket bonded to the flange. The body gasket shall be a full circle, grid pattern, converting the entire length of the sleeve, cloth reinforced with attached stainless steel bridge to support the gasket at the lugs. The gasket shall be made of SBR rubber or similar material, compounded for use with water, salt solution, mild acids, bases and sewage. The sleeve shall have a 3/4-inch NPT bronze or stainless steel test plug. All welds shall conform to ASTM A380 and shall be fully passivated. Tapping sleeves 8-inch and smaller may have outlet connection to fit a mechanical joint tapping valve.



# ***JEA Water and Wastewater Standards***

## ***351 Water Meters, Valves, Hydrants, and Appurtenances***

### **IV.1.3. CARBON STEEL**

Fabricated mechanical joint tapping sleeve may be used on 30-inch pipe and larger. Sleeve shall be rated for 150 psi (minimum), body shall meet ASTM 283 Grade C and be epoxy coated (10 mils minimum), alloy steel lug bolts, SBR wedge type gaskets and include ¾ NPT (minimum) test plug.

## **IV.2. TAPPING VALVES**

### **IV.2.1. GENERAL**

Tapping valves shall be iron body with stainless steel bolts and nuts, bronze mounted gate valves, non-rising stem, open left, resilient seat, 2-inch square operating nut, for vertical mounting in approximately level setting on buried water lines. The valve ends shall be mechanical joint for use with ductile iron pipe on one side and standard flanged (Class 125) on the other. Tapping valves 8-inch size and smaller may be MJ by MJ valve ends to match sleeve (standard MJ gate valve). Valves shall conform to the applicable section of these specifications.

### **IV.2.2. DISINFECTION OF TAPPING OR DRILLING MACHINE**

Prior to tapping a potable water main, the drilling machine's pilot drill, shell cutter and cutter hub shall be sterilized in accordance with the following procedure:

Four gallons of potable water shall be combined with 8 oz. of sodium hypochlorite (household bleach); the pilot drill, shell cutter and cutter hub shall be swabbed until clean or totally immersed in the sterilizing solution and allowed to remain wet at least five minutes before tapping operation commences. It is not necessary to rinse the sterilizing solution from tapping components prior to use.

### **IV.2.3. HYDROSTATIC AND LEAKAGE TEST**

After installing a tapping sleeve and valve, and prior to tapping of a pressurized water main, a hydrostatic and leakage test shall be performed. The test will be conducted by introducing water into a tap or test hole located at the neck of the outlet half of the sleeve, on sleeves furnished with said tap, and with the tapping valve in the closed position. Sleeves shall be provided with a test plug. The sleeve and valve shall be capable of maintaining a test pressure of 150 psi for 15 minutes duration, with no sign of visible leaks. All leaks shall be repaired by removing and replacing defective items with items free of defects, after which the sleeve and valve shall be re-tested. Such repair and re-testing shall be done until the installation passes the specified test. The Contractor shall furnish and install any necessary temporary restraints, gauges, pumps and other incidental and appurtenant items necessary to complete this work, and shall remove same upon completion of the test. A watertight plug (bronze or stainless steel), shall then be inserted into the test hole.

## **IV.3. CORPORATION STOPS**

Corporation stops shall be required on all services, regardless of size, and shall be manufactured from cast bronze with machined fitting surfaces, and in accordance with AWWA C800 in sizes ¾ inch through 2 inches. The inlet connection shall be AWWA standard corporation stop thread or iron pipe (IPT) thread. The outlet connection shall be a flare nut fitting for Type K copper tubing or a pack joint (or compression joint) outlet for copper or polyethylene tubing. Corporation stops shall be installed directly into the service saddle (no nipple between saddle and corp stop).

## **IV.4. CURB STOP**

Curb stops shall be manufactured from cast bronze with machined fitting surfaces and in accordance with AWWA C800 in sizes ¾ inch through 2 inches. Curb stop shall be full-port ball valve with check, combined

# *JEA Water and Wastewater Standards*

## *351 Water Meters, Valves, Hydrants, and Appurtenances*

cap and tee, with lock wing cast on stop body and operating tee cap to provide for locking the stop in closed position. Curb stops for use with copper services shall have an inlet connection with a flare nut fitting for Type K copper tubing. Curb stops utilizing poly tubing shall have an inlet connection with a pack joint or compression joint. Curb stops for use with Schedule 40 PVC pipe shall have inlet connections with female iron pipe threads. All curb stops shall have an outlet connection with female iron pipe thread.

### **IV.5. BALL VALVES**

Ball valves shall be limited to 3/4 inch through 2 inches in size and shall have cast bronze body, bronze tee head, stem with check, full round way opening and provisions for locking in a closed position. Ball valves for use with copper services shall have an inlet connection with a flare nut fitting for Type K copper tubing and an outlet connection with female iron pipe thread, or shall have an inlet connection with a compression joint (insert stiffener will be used with plastic service connections) and an outlet connection with female iron pipe thread. Ball valves for use with Schedule 40 PVC pipe shall have an outlet connection with female iron pipe threads and an inlet connection with either a compression joint or female iron pipe threads. The latter will require the use of an approved Schedule 40 PVC Adapter (MIPT X SLIP). Compression joints will require insert stiffeners. Below grade ball valves on water mains must have 2-inch operating nuts and be installed in standard valve boxes.

### **IV.6. SERVICE SADDLE OR SERVICE TAPPING SADDLE**

#### **IV.6.1. STAINLESS STEEL BAND SADDLES**

Service saddles shall include stainless steel bands with either 3 mil thickness (minimum) epoxy or poly coated (malleable or ductile) iron body or 85 – 5 – 5 – 5 bronze body. Single band saddles may be utilized on new 1-inch water services which are installed on a dry 10-inch size or smaller water main. For wet taps or water mains 12-inch size and larger, a double band saddle is required. Outlet sizes shall be 1-inch through 2-inches and have iron pipe threads (IPS). The outside diameter range of the saddle shall be properly sized to conform to the type of pipe being tapped without placing undue stress on the pipe. Pipe shavings or cuttings, including coupon, shall not enter the host pipe during the tapping operation.

#### **IV.6.2. BRASS SADDLES**

Brass saddles may be utilized on new 1-inch and smaller water services which are installed on a dry 10-inch size or smaller PVC water main. The body and strap shall be 85 – 5 – 5 – 5 cast bronze and shall be specifically sized for C900 (OD) PVC pipe. Bolts shall be silicon bronze grade or stainless steel. The strap shall be hinged or 2-piece design and tapped to eliminate the need for a nut (no loose nuts). Gasket shall be grade 60 "O" ring or equal and cemented in place.

### **IV.7. COMBINATION AIR VALVES**

Combination air valve shall be automatic float operated, all stainless steel trim Valve shall be stainless steel 1" inlet (min.), stainless steel compound lever design and compliance with AWWA C-512. Install combination air valve with double stainless steel band saddle and corporation stop (connected directly into saddle with no nipples). All 2' and smaller piping associated with this installation shall be stainless steel. Piping larger than 2" size shall be ductile iron. If the installation of the ARV requires a manhole, then the manhole shall be installed similar to the requirements of wastewater construction detail S-29, including off-set piping, support bracket and other appurtenances as shown (no specialty interior manhole lining; stainless steel pipe is optional).

## **V. FIRE HYDRANTS**

# *JEA Water and Wastewater Standards*

## *351 Water Meters, Valves, Hydrants, and Appurtenances*

### **V.1. GENERAL**

Fire hydrants shall be 5 1/4 inch ductile iron body, dry-barrel, fully bronze mounted, for minimum 150 psi working pressure, complying with ANSI/AWWA Standard C502, Associates Factory Mutual Fire Insurance Companies and listed with Underwriters Laboratories. The inlet connection shall be 6-inch mechanical joint type. All nut and bolts shall be 304 stainless steel. The integral shut-off valve shall be compression type opening against water pressure and open left (counter-clockwise) as marked on the bonnet. The main valve seat and the threaded portion of the hydrant into which it screws shall be bronze or stainless steel. The hydrant barrel drain valve and port shall be bronze. The hydrant barrel drain shall be actuated by operation of the main valve stem. The stem operating threads and thrust bearing shall be sealed, by "O" rings, from exposure to moisture and shall be provided with means for lubrication. The hose nozzles shall be bronze with National Standard fire hose coupling screw threads, one 4½ inch pumper nozzle and two 2½ inch hose nozzles. The hydrant operating nut and nozzle cap nuts shall be pentagon shaped (5-sided) measuring 1½ inches from point to flat. The nozzle caps shall be securely chained to the hydrant barrel and be constructed of heavy duty corrosion-resistant material. The hydrants shall be "Traffic" type with a frangible flange or lugs and operating stem section at the ground level. The outside surface of the upper barrel (top) of the hydrant and all above ground piping shall be primed and then painted with "Traffic Yellow" color (RUS-KIL Enamel – International yellow or equal). The base (shoe) shall be painted with a minimum 4-mils thick epoxy (inside and outside surfaces). The lower barrel (inside and outside surfaces) and the inside surface of the upper barrel shall be asphaltic or epoxy coated.

### **V.2. FIRE HYDRANTS LOCATED OUTSIDE OF DUVAL COUNTY**

Fire Hydrants located outside of Duval County shall meet the specific requirements (material and location) of that county, fire department or municipality.

### **V.3. RAISED PAVEMENT MARKERS**

- V.3.1. The blue reflective markers shall consist of a molded methyl methacrylate or an acrylonitrile butadiene-styrene (ABS) shell filled with a mixture of an inner thermostating compound and filler material.
- V.3.2. The marker shall have a maximum width of five (5) inches and a maximum height of 0.75 inch. The minimum area of each reflective face shall be 1.5 square inches. The outer surface shall be smooth and all corners and edges exposed to traffic shall be rounded. The base shall be substantially free of glass or substances that may reduce their bond to adhesive.
- V.3.3. The marker shall support a minimum load of 2,000 pounds when tested in accordance with a manufacturer developed test approved by the Florida Department of Transportation.
- V.3.4. Bituminous adhesive as recommended by the marker manufacturer shall be used for bonding the markers to the pavement. The adhesive used shall be one of the products included on the Florida Department of Transportation (F.D.O.T.) Qualified Products List. Reflective markers shall be installed in such a manner that the reflective face of the marker is perpendicular to a line parallel to the roadway centerline. The blue reflective markers shall be placed in the center of the travel lane, directly across from and adjacent to each fire hydrant.

## **VI. VALVE BOXES**

### **VI.1. CONCRETE COLLAR**

# *JEA Water and Wastewater Standards*

## *351 Water Meters, Valves, Hydrants, and Appurtenances*

The Contractor shall furnish, assemble and install a valve box for each buried valve. Each valve box installed in un-paved areas shall be installed with a 24-inch round or square, 6-inch thick concrete collar with #4 reinforcing rebar rings, poured around the top of the valve box cover. The concrete shall have a minimum strength of 3000 psi. In lieu of a poured concrete collar, a pre-cast concrete valve pad may be utilized which meets the requirements below.

### **VI.2. PRECAST CONCRETE VALVE COLLAR**

The concrete valve pad shall consist of the following:

- VI.2.1. Concrete rated at 4,000 psi (minimum). Fiber mesh re-enforcement is optional. Concrete shall be smooth and in one piece, with no cracks.
- VI.2.2. Pad must include two #2 (minimum) steel rebar rings for structural support.
- VI.2.3. Concrete thickness shall be 4 inches at the center and tapered to 2 inches at the outside edges.
- VI.2.4. The dimensions shall be 23-1/2 inches OD (minimum) with a 10-inch OD centered-hole.
- VI.2.5. This installation shall include applying grout in the annular space between the OD of the valve box and concrete pad. For support and adhesion, the grout shall be placed in the entire 4-inch vertical annular area within the pad open-hole space. The concrete pad must be placed on firm compacted sand. The top of the concrete pad shall be level with the top of the cast iron valve box and level with grade. The required brass valve identification tag shall be attached to wire with electric tie straps to the inside of the cast iron valve cover.

### **VI.3. VALVE TAGS**

Provide brass identification tag with "Water", valve size, valve type and direction and number of turns to open. Provide a ¼ Inch hole in the brass tag and attach the tag to the end of the locate wire (twist wire around tag). Tag shall be 3-inch diameter and ⅛ inch thick brass with a ¼ inch hole.

### **VI.4. VALVE BOXES**

Adjustable valve boxes of suitable length shall be used. Cover shall be marked "Water". The top section shall be adjustable for elevation and shall be set to allow equal movement above and below finished grade. The base shall be centered over the valve and shall be on line with nut at top of valve stem and the entire assembly shall be plumb. Boxes shall be cast iron. Cast iron castings shall be manufactured of clean, even grain, gray cast iron conforming to ASTM Designation A48, Class 20B, Gray Iron Castings; and shall be smooth, true to pattern, free from blow holes, sand holes, projections, or other harmful defects and shall be coated with a single thin coat of coal tar epoxy. The cover will not rock after it has been seated in any position in its associated jacket.

## **VII. METER BOXES**

### **VII.1. SMALL METER BOXES (FOR 2-INCH AND SMALLER METERS)**

Polymer Concrete shall be used for 2-inch and smaller meters meter boxes and lids shall be manufactured using fiberglass reinforced materials and polymer concrete. The body of the box shall be manufactured using fiberglass reinforced materials, comprised from polyester resins and fiberglass matting. The top color of the box shall be manufactured from poured polymer concrete and shall be off-white color to match cover. The top (cover shall be manufactured using polymer concrete (off-white color). The size of the meter box and load ratings shall be as specified in the standard details (plates). To obtain approval by JEA, the load

# ***JEA Water and Wastewater Standards***

## ***351 Water Meters, Valves, Hydrants, and Appurtenances***

ratings shall be certified by a professional engineer or state certified testing lab. The lid shall also be certified by Cellnet Technology and Sensus Metering Systems to be "RF" compatible with the Sensus MTU.

### **VII.2. LARGE METER BOXES (FOR 3-INCH AND LARGER METERS)**

The large meter box shall meet the specification requirements as shown on water construction Detail No. W-8.

### **VIII. BACKFLOW PREVENTION DEVICES**

Where called for on the drawings, the backflow prevention devices shall be the type as listed in JEA's "Rules and Regulations for Water and Wastewater Services" manual. If reclaimed water is available for irrigation use, the potable water customer is required to install and maintain a JEA approved cross-connection device on their potable water service line (see water construction detail W-15). Operation and maintenance of this cross-connection device shall comply with JEA's cross-connection control program and associated operating policies. All reduced pressure assemblies shall be mounted above grade.

### **IX. DUCTILE IRON BODY INSERT VALVE**

#### **IX.1. GENERAL**

The ductile iron 250 p.s.i.g. rated insert valve shall be a resilient wedge gate valve designed for use in potable water, raw water, reclaimed water, sewage, irrigation and backflow control systems. The design will allow the valve to be installed into an existing pressurized pipeline while maintaining constant pressure and service.

#### **IX.2. DUCTILE IRON BODY**

IX.2.1. The ductile iron body, bonnet and wedge shall meet or exceed the requirements of AWWA C515 with 250 psig maximum working pressure. The pressure rating markings must be cast into the body of the insert valve. The Insert Valve shall be ductile iron construction meeting ASTM A536 Grade 65-45-12.

IX.2.2. Valve bodies sized 12" and smaller shall be capable of installation on cast/grey iron or ductile iron Class A B C and D, IPS PVC, C900 and C909 PVC, Steel, AC pipe diameters without changing either top or bottom portion of split valve body.

IX.2.3. Bolting materials shall develop the physical strength requirements of ASTM A307 with dimensions conforming to ANSI B18.2.1.

#### **IX.3. RESILIENT WEDGE GATE ASSEMBLY**

IX.3.1. The construction of the resilient wedge shall comply with AWWA C509.

IX.3.2. The ductile iron wedge shall be fully encapsulated with EPDM rubber by a high pressure and high temperature compression or injection mold process.

IX.3.3. The resilient wedge shall seat on the valve body and not the carrier pipe to obtain the optimum seating and flow control results. The resilient wedge shall be totally independent of the carrier pipe.

IX.3.4. The resilient wedge shall not come into contact with the carrier pipe or depend on the carrier pipe to create a seal.

# ***JEA Water and Wastewater Standards***

## ***351 Water Meters, Valves, Hydrants, and Appurtenances***

- IX.3.5. Pressure equalization on the down or upstream side of the closed wedge shall not be necessary to open the valve.
- IX.3.6. The wedge shall be symmetrical and seal equally with flow in either direction.
- IX.3.7. The resilient wedge must ride inside the body channels to maintain wedge alignment throughout its travel to achieve maximum fluid control regardless of high or low flow pressure or velocity. The resilient wedge must have more support than the operating stem as the resilient wedge enters and exits the water (fluid) way.

### **IX.4. FUSION BOND EPOXY COATING**

- IX.4.1. The insert valve shall be shop epoxy coated on the interior and the exterior. The fusion-bonded coating shall be applied prior to assembly so that all casting surfaces, including the bolt holes and body-to-bonnet flange surfaces are fully epoxy coated.
- IX.4.2. Valve shall be coated with a minimum of 8 mils fusion bond epoxy in compliance with AWWA C550 and certified to ANSI/NSF-61.

### **IX.5. GASKETS AND O-RING STEM SEALS**

- IX.5.1. The inset valve shall have O-Ring stem seals. Two O-Rings shall be located above, and one O-Ring shall be located below the thrust collar. The lower two O-Rings shall provide a permanently sealed lubrication chamber. The upper O-Ring shall protect the lower O-Rings.
- IX.5.2. Side flange seals shall be of the O-Ring type of either round, oval, or rectangular cross-sectional shape.

### **IX.6. VALVE STEM AND THRUST WASHERS**

- IX.6.1. Insertion valves shall be NRS (non-rising stem) and operate with standard turns 3 turns per diameter inch to open and close.
- IX.6.2. The gate valve stem must be made of stainless steel.
- IX.6.3. The gate valve stem shall be able to withstand torque of 700 ft. lbs. of torque without compromising operation.
- IX.6.4. The NRS stem must have an integral thrust collar in accordance with Section 4.4.5.3 of AWWA C515 Standard. Two-piece stem collars are not acceptable. The wedge nut shall be independent of the wedge and held in place on three sides by the wedge to prevent possible misalignment. The gate valve stem and wedge nut shall be a copper alloy in compliance with AWWA Standard 515, Section 4.4.5.1.
- IX.6.5. Two thrust washers are required. One is located above, and one is located below the stem thrust collar.
- IX.6.6. The valve shall be operated by 2" square wrench nut according to ASTM A126 CL.B – open left (counter-clockwise).

# *JEA Water and Wastewater Standards*

## *351 Water Meters, Valves, Hydrants, and Appurtenances*

### **IX.7. SPLIT JOINT RESTRAINT**

- IX.7.1. Shall consist of multiple gripping wedges incorporated into a follower gland meeting the applicable requirements of ANSI/AWWA C110/A21.10.
- IX.7.2. The devices shall have a working pressure rating of 350 psi for 4-12 inch. Ratings are for water pressure and must include a minimum safety factor of 2 to 1 in all sizes.
- IX.7.3. Gland body, wedges and wedge actuating components shall be cast from grade 65-45-12-Ductile iron material in accordance with ASTM A536.
- IX.7.4. The mechanical joint restraint shall retain full mechanical joint deflection during assembly as well as allowing joint deflection after assembly.
- IX.7.5. Proper actuation of the gripping wedges shall be ensured with torque limiting twist off nuts. Pressure point set screw type hardware shall not be used.
- IX.7.6. Restraint devices shall be Listed by Underwriters Laboratories and Approved by Factory Mutual (3" through 12" inch size).

### **IX.8. PRESSURE TESTING**

After the installation of the insert valve body on to the existing pipe a pressure test of 150 P.S.I.G. shall sustained for 15 minutes. Once the pressure test is affectively achieved the insert valve body shall not be moved as per AWWA Standards. If the insert valve is moved the pressure test must be completed again. The insert valve must not be moved or repositioned once the pressure test is satisfactorily completed and approved by the Owner/ Engineer.

## **X. INSPECTION CHECK LISTS AND REPORTS**

# JEA Water and Wastewater Standards

## 351 Water Meters, Valves, Hydrants, and Appurtenances

### X.1. VALVE INSPECTION CHECKLIST

Project Name: \_\_\_\_\_

Street/Intersection/Address Location: \_\_\_\_\_

Availability Number: \_\_\_\_\_ Project Number: \_\_\_\_\_ Valve Number: \_\_\_\_\_

Date/Time: \_\_\_\_\_

STA: \_\_\_\_\_

Offset: \_\_\_\_\_

Valve Size: \_\_\_\_\_

Valve Type: \_\_\_\_\_

Valve Depth to Nut (inches): \_\_\_\_\_

Number of Turns to open (count): \_\_\_\_\_

Valve use:  Mainline  Independent  Stub  Fire line

Service:	<input type="checkbox"/>	Potable Water
	<input type="checkbox"/>	Reclaimed Water
	<input type="checkbox"/>	Wastewater
Location:	<input type="checkbox"/>	Paved Area
	<input type="checkbox"/>	Grassed Area
Pad:	<input type="checkbox"/>	Concrete
	<input type="checkbox"/>	Asphalt
	<input type="checkbox"/>	N/A
Cover at Finished Grade:	<input type="checkbox"/>	Yes
	<input type="checkbox"/>	No - adjust per spec
Color Coded Cover per spec:	<input type="checkbox"/>	Yes
	<input type="checkbox"/>	No – provide color coded cover
Brass Tag Affixed:	<input type="checkbox"/>	Yes
	<input type="checkbox"/>	No
If No, is this a fire hydrant branch line?:	<input type="checkbox"/>	Yes
	<input type="checkbox"/>	No - provide brass tag per spec
Valve nut accessible:	<input type="checkbox"/>	Yes
	<input type="checkbox"/>	No - adjust per detail
Extension Provided (> 30 inches depth to nut)	<input type="checkbox"/>	Yes
	<input type="checkbox"/>	No--provide extension per spec.
Open Direction	<input type="checkbox"/>	Left
	<input type="checkbox"/>	Right – replace per spec



***JEA Water and Wastewater Standards***  
***351 Water Meters, Valves, Hydrants, and Appurtenances***

Valve exercised (Start closed then open fully):	<input type="checkbox"/>	Yes
	<input type="checkbox"/>	No
Valve position (after exercised):	<input type="checkbox"/>	Open (mainline / independent / fire)
	<input type="checkbox"/>	Partially closed (Stub)
Locate wire accessible in jacket	<input type="checkbox"/>	Yes
	<input type="checkbox"/>	No
Locate wire color coded	<input type="checkbox"/>	Yes
	<input type="checkbox"/>	No

Comments: \_\_\_\_\_  
\_\_\_\_\_  
\_\_\_\_\_

Contractor Representative: \_\_\_\_\_  
Signature & Printed Name

JEA Inspector: \_\_\_\_\_  
Signature & Printed Name

JEA O&M representative: \_\_\_\_\_  
Signature & Printed Name

Commissioned Date: \_\_\_\_\_

# JEA Water and Wastewater Standards

## 351 Water Meters, Valves, Hydrants, and Appurtenances

### X.2. AIR RELEASE VALVE INSPECTION CHECKLIST

Project Name: \_\_\_\_\_

Street/Intersection/Address Location: \_\_\_\_\_

Availability Number: \_\_\_\_\_ Project Number: \_\_\_\_\_ ARV Number: \_\_\_\_\_

Date/Time: \_\_\_\_\_

STA: \_\_\_\_\_ Offset: \_\_\_\_\_

ARV Size (Inch): \_\_\_\_\_

Service:	<input type="checkbox"/>	Potable Water
	<input type="checkbox"/>	Reclaimed Water
	<input type="checkbox"/>	Wastewater
Connection:	<input type="checkbox"/>	Offset connection
	<input type="checkbox"/>	Direct connection (i.e. vault over main)
Vault Cover elevation:	<input type="checkbox"/>	Finish Grade
	<input type="checkbox"/>	Below/above finish grade – adjust per spec
Vault box interior lined:	<input type="checkbox"/>	Yes
	<input type="checkbox"/>	No – line per spec
	<input type="checkbox"/>	Not applicable – water, reclaimed or chilled main
Clearance - bottom of vault cover and top of ARV	<input type="checkbox"/>	8 inches or greater
	<input type="checkbox"/>	Less than 8 inches – adjust per detail
Valve position:	<input type="checkbox"/>	Open
	<input type="checkbox"/>	Closed
Stainless Steel Ball Valves	<input type="checkbox"/>	Yes
	<input type="checkbox"/>	No - replace per spec
Stainless steel piping or fittings	<input type="checkbox"/>	Yes
	<input type="checkbox"/>	No - replace per spec
Locate wire accessible in box	<input type="checkbox"/>	Yes
	<input type="checkbox"/>	No
Locate wire color coded	<input type="checkbox"/>	Yes
	<input type="checkbox"/>	No

Comments:

\_\_\_\_\_

\_\_\_\_\_

***JEA Water and Wastewater Standards***  
***351 Water Meters, Valves, Hydrants, and Appurtenances***

Contractor Representative:

\_\_\_\_\_  
Signature & Printed Name

JEA Inspector:

\_\_\_\_\_  
Signature & Printed Name

JEA O&M representative:

\_\_\_\_\_  
Signature & Printed Name

Commissioned Date:

# *JEA Water and Wastewater Standards*

## *351 Water Meters, Valves, Hydrants, and Appurtenances*

### X.3. LOCATE WIRE BOX INSPECTION CHECKLIST

Project Name: \_\_\_\_\_

Street/Intersection/Address Location: \_\_\_\_\_

Availability Number: \_\_\_\_\_ Project Number: \_\_\_\_\_ Date/Time: \_\_\_\_\_

STA: \_\_\_\_\_ Offset: \_\_\_\_\_

Service:	<input type="checkbox"/>	Potable Water
	<input type="checkbox"/>	Reclaimed Water
	<input type="checkbox"/>	Wastewater
Curb Stamp w/Color Coding:	<input type="checkbox"/>	Yes
	<input type="checkbox"/>	No - Fix
Cover at Finished Grade	<input type="checkbox"/>	Cover above finish grade--adjust per spec.
	<input type="checkbox"/>	Cover below finish grade--adjust per spec.
Frame condition:	<input type="checkbox"/>	Good
	<input type="checkbox"/>	Cracked/broken - provide replacement
	<input type="checkbox"/>	Offset - needs resetting/re-grouting
Locate wire accessible in box:	<input type="checkbox"/>	Yes
	<input type="checkbox"/>	No, full of debris - excavate debris
Locate wire properly color coded:	<input type="checkbox"/>	Yes
	<input type="checkbox"/>	No--replace per spec
Locate wire signal verified:	<input type="checkbox"/>	Yes
	<input type="checkbox"/>	No, lined, fiberglass or polymer concrete
	<input type="checkbox"/>	No--repair per spec

Comments: \_\_\_\_\_

Contractor Representative: \_\_\_\_\_  
Signature & Printed Name

JEA Inspector: \_\_\_\_\_  
Signature & Printed Name

JEA O&M representative: \_\_\_\_\_  
Signature & Printed Name

Commissioned this date: \_\_\_\_\_  
Signature & Printed Name

# JEA Water and Wastewater Standards

## 351 Water Meters, Valves, Hydrants, and Appurtenances

### X.5. TRACER WIRE CERTIFICATION FORM

Project Name: \_\_\_\_\_

Availability Number: \_\_\_\_\_ Project Number: \_\_\_\_\_ Date/Time: \_\_\_\_\_

Service:  Potable Water  
 Reclaimed Water  
 Wastewater

Continuity/Signal strength between access points:			Marker Balls Installed / Located (Check)			
Access pt #1 to access pt #2:			Installed		Located	
Access pt #2 to access pt #3:			Installed		Located	
Access pt #3 to access pt #4:			Installed		Located	
Access pt #4 to access pt #5:			Installed		Located	
Access pt #5 to access pt #6:			Installed		Located	
Access pt #6 to access pt #7:			Installed		Located	
Access pt #7 to access pt #8:			Installed		Located	
Access pt #8 to access pt #9:			Installed		Located	
Access pt #9 to access pt #10:			Installed		Located	

	Water	Sewer / FM	Reclaimed Water	Fiber Optic
Total footage tested				

If any faults found List below (please indicate utility type and location)	
Fault # 1:	
Fault # 2:	
Fault # 3:	
Fault # 4:	

Comments: \_\_\_\_\_

\_\_\_\_\_

***JEA Water and Wastewater Standards***  
***351 Water Meters, Valves, Hydrants, and Appurtenances***

Name of Tester:

\_\_\_\_\_  
Signature & Printed Name

Testing Company:

\_\_\_\_\_  
Printed Name

Contractor Representative:

\_\_\_\_\_  
Signature & Printed Name

Installation Contractor:

\_\_\_\_\_  
Printed Name

JEA Inspector:

\_\_\_\_\_  
Signature & Printed Name

JEA O&M representative:

\_\_\_\_\_  
Signature & Printed Name

Commissioned this date:

\_\_\_\_\_  
Signature & Printed Name

Locate Wire Test Results

Pass

Fail

*Blank Page*

## **SECTION IV – WASTEWATER COLLECTION SPECIFICATIONS**

- 427 - Wastewater Manholes
- 428 - Gravity Wastewater
- 429 - Wastewater Force Mains
- 430 - Wastewater Valves and Appurtenances
- 433 - Submersible Wastewater Pumping Stations
- 435 - Booster Wastewater Pumping Stations
- 445 - Pump Station Operation and Maintenance Data Submission Requirements
- 446 - Specialty Coatings and Linings
- 448 - Existing Concrete Preparation and Repair
- 470 - Emergency Pump Engines



*Blank Page*

## 427 - WASTEWATER MANHOLES

### I. GENERAL REQUIREMENTS

#### I.1. SCOPE OF WORK

The work under this section shall include all labor, material and equipment necessary for the construction and installation of all new wastewater manholes and the removal of existing wastewater manholes as called for on the drawings. All references to Industry Standards (ASTM, ANSI, AWWA, etc.) shall be to the latest revision unless otherwise stated. Only those materials included in the JEA Water and Wastewater Standards Manual shall be installed. All materials shall be new unless specifically called for otherwise.

#### I.2. MANHOLE APPLICATION TABLE

Selection Table for Application of new and Rehab Manhole Construction	Polymer Concrete Manhole	Precast Concrete Manhole	Fiberglass Manhole
Pipe to 12" New Construction	Yes	Yes	
Pipe 12" and greater	Yes		
Force main to manhole	Yes		
High line to manhole	Yes		
Interceptor/splitter box	Yes		
Junction manhole	Yes		
Rehab manhole	Yes	*Yes	*Yes
Manhole depth less than 10'	Yes	Yes	
Manhole depth greater than 10'	Yes		
Inside/outside drop	Yes	*Yes	
ARV manholes	Yes		
* Liner required: Liner manufacturer to certify manhole structural integrity for rehab. Manufacturer of the chemical resistant surface shall provide a 10-year warranty against chemical deterioration of the manhole structure and the chemical resistant surface.			

#### I.3. PROJECT SCHEDULE AND COOPERATION

The project schedule shall be established based on working a normal work schedule including five days per week, single shift, eight hours per day or four days per week, single shift, ten hours per day. Unless approved otherwise by JEA, normal or general items of work, such as T-V inspections, density testing and final inspections, shall be scheduled during the normal work schedule. Due to operational and work force limitation on the JEA systems, JEA will require the contractor to perform work outside the normal work schedule. These operational and work force limitations, including but not limited to tie-in work (cut-in work or other tie-in work) and other phases of the work which may impact the continued (non- interruptible) service to existing JEA customers. The contractor shall plan and anticipate the cost impact of these system limitations and provide such work or services at no additional cost to JEA.

#### I.4. SHOP DRAWING SUBMITTALS

# *JEA Water and Wastewater Standards*

## *427 Wastewater Manholes*

Actual catalog data, brochures and descriptive literature will not be required for items of standard usage which meet the requirements of Chapter X. and Chapter XI. Of the JEA Water and Wastewater Standards Manual. Any specialty item not shown in this manual will require a complete shop drawing submittal. The Engineer may at any time require the Contractor to provide a complete detailed shop drawing submittal for any material which, in the Engineer's opinion, may not be in compliance with the JEA Water and Wastewater Standards. The Contractor shall submit shop drawings consisting of individual manholes showing invert elevations, pipe sizes and similar details for approval before placing order for wastewater manholes.

Submit manufacturer's data and details of following items for approval:

- I.4.1. Shop drawings of manhole sections, base units and construction details, jointing methods, materials, and dimensions.
- I.4.2. Summary of criteria used in manhole design including, as minimum, material properties, loading criteria, and dimensions assumed. Include certification from manufacturer that polymer concrete manhole design meets or exceeds the load and strength requirements of ASTM C 478 and ASTM C 857, reinforced in accordance with ACI 440.1R-15. Include current ISO 9001:2008 certification
- I.4.3. Frames, grates, rings, and covers
- I.4.4. Materials to be used in fabricating pipe drop connections
- I.4.5. Materials to be used for pipe connections
- I.4.6. Materials to be used for stubs and stub plugs, if required.
- I.4.7. Proof of independent chemical resistance testing conducted in accordance with the Standard Specifications for Public Works Construction (California Greenbook) Section 211-2.
- I.4.8. Submitted sealed drawings by a registered Professional Engineer

### **I.5. MANHOLE INSPECTION CHECKLIST**

Contractor shall schedule a final walk through (prior to substantial completion) in order to create a punch list for each project. List of attendees shall include but not be limited to the Contractor's representative, JEA representative (i.e. project inspector), and designated JEA Operation personnel. Contractor shall be required to provide a crew complete with all necessary equipment to allow observation of each new and rehabilitated manhole interior. The Contractor's representative shall complete the JEA Final Inspection Checklist for each new or rehabilitated manhole structure, and have the JEA attendees provide original signatures/names on the signature block. The JEA representative shall scan the checklists and ensure the documents are filed in the electronic file folder for the project.

### **I.6. AS-BUILT DRAWINGS**

As-built drawings to be utilized in future utility locate work are required on all water, wastewater, force main, pump station and reclaimed water projects, including projects for JEA, City of Jacksonville, JTA, DOT, private developments, (utilities to be dedicated to JEA), and other City Authorities, etc. As-built drawings shall be in accordance with specifications Chapter VI. 1. - Section 501, entitled "As-built Drawings". As-built drawings shall be reviewed and approved by JEA. The cost to provide as-built drawings shall be included as part of the related work requirements or general conditions for the utility work.

### **I.7. WARRANTY**

# ***JEA Water and Wastewater Standards***

## ***427 Wastewater Manholes***

### **I.7.1. CONTRACTOR WARRANTY**

The Contractor shall supply to JEA a two (2) year unconditional warranty. The warranty shall include materials and installation and shall constitute complete replacement and delivery to the site of materials and installation of same to replace defective materials or defective workmanship with new materials/workmanship conforming to the specifications.

### **I.7.2. PRODUCT WARRANTY**

#### **I.7.2.1. Polymer Concrete Manholes**

The Manufacturer shall supply to JEA a fifty (50) year unconditional warranty to include corrosion. The warranty shall include materials and installation and shall constitute complete replacement and delivery to the site of materials and installation of same to replace defective materials or defective workmanship with new materials/workmanship conforming to the specifications.

#### **I.7.2.2. Fiberglass Manholes**

The Manufacturer shall supply to JEA a ten (10) year unconditional warranty to include corrosion. The warranty shall include materials and installation and shall constitute complete replacement and delivery to the site of materials and installation of same to replace defective materials or defective workmanship with new materials/workmanship conforming to the specifications.

## **II. MATERIALS**

### **II.1. POLYMER CONCRETE MANHOLES**

#### **II.1.1. PRODUCT STANDARDS**

All material shall be free from defects impairing strength and durability, shall be of the best commercial quality for the purpose specified, and shall have structural properties sufficient to safely sustain or withstand strains and stresses to which it is normally subjected and be true to detail. Materials, construction and finished products must adhere to the most current version of the following standards:

II.1.1.1. ASTM C 478 Standard Specification For Precast Reinforced Concrete Manhole Sections

II.1.1.2. ASTM C 579 Standard Test Methods For Compressive Strength Of Chemical-Resistant Mortars, Grouts, Monolithic, Surfacing, And Polymer Concretes

II.1.1.3. ASTM C 443 Standard Specification For Joints For Concrete Pipe And Manholes Using Rubber Gaskets

II.1.1.4. ASTM C 580 Standard Test Method For Flexural Strength And Modulus Of Elasticity Of Chemical-Resistant Mortars, Grouts, Monolithic Surfacing, And Polymer Concretes

II.1.1.5. ASTM C 857 Standard Practice For Minimum Structural Design Loading For Underground Utility Structures

# ***JEA Water and Wastewater Standards***

## ***427 Wastewater Manholes***

- II.1.1.6. ACI 350-06 Code Requirements For Environmental Engineering Concrete Structures & Commentary
- II.1.1.7. ACI 440.1R-15 Guide For The Design And Construction Of Structural Concrete Reinforced With Fiber-Reinforced Polymer (FRP) Bars
- II.1.1.8. ACI 548.6R-96 Polymer Concrete-Structural Applications State-Of-The-Art Report
- II.1.1.9. ASTM D 648 Test Method For Deflection Temperature Of Plastics Under Flexural Load In Edgewise Position
- II.1.1.10. ASTM D 6783 Standard Specification For Polymer Concrete Pipe
- II.1.1.11. ASTM D 2584 Test Method For Ignition Loss Of Cured Reinforced Resins
- II.1.1.12. ASTM C 923 Standard Specifications For Resilient Connectors Between Concrete Manholes Structures And Pipe
- II.1.1.13. ASTM C 990 Standard Specification For Joints For Concrete Pipe, Manholes And Precast Box Sections Using Preformed Flexible Joint Sealants
- II.1.1.14. ASTM C 497 Test Methods For Concrete Pipe, Manhole Sections, Or Tile
- II.1.1.15. California Greenbook Standard Specifications For Public Works Construction Section 211-2

### **II.1.2. PRODUCT REQUIREMENTS**

- II.1.2.1. Reference the Manhole Application Table above for allowed installation locations.
- II.1.2.2. Provide base riser section with monolithic floors, unless shown otherwise.
- II.1.2.3. Provide riser sections joined with bell and spigot/ship-lap design seamed with butyl mastic and or rubber gaskets (ASTM C 990) so that on assembly, manhole base, riser and top section make a continuous and uniform manhole structure.
- II.1.2.4. Construct riser sections for polymer concrete manholes from standard polymer concrete manhole sections of the diameter indicated on drawings. Use various lengths of polymer concrete manhole sections in combination to provide correct height with the fewest joints.
- II.1.2.5. Design wall sections for depth and loading conditions with wall thickness as designed by polymer concrete manufacturer.
- II.1.2.6. Provide tops to support AASHTO HS-20 or HL-93 or vehicle loading or loads as required and receiving cast iron frame covers or hatches, as indicated on drawings.

### **II.1.3. DESIGN LOADING REQUIREMENTS**

## ***JEA Water and Wastewater Standards***

### ***427 Wastewater Manholes***

- II.1.3.1. Polymer Concrete Manhole risers, cones, flat lids, grade rings and manhole base sections shall be designed by manufacturer to meet loading requirements of ASTM C 478, ASTM C 857 and ACI 350-06 as modified for polymer concrete manhole design.
- II.1.3.2. AASHTO HS-20 or HL-93 design or as required loading applied to manhole cover and transition and base slabs.
- II.1.3.3. Polymer manholes will be designed based upon live and dead load criteria in ASTM C 857 and ACI 350-06.
- II.1.3.4. Unit soil weight of 120 pcf located above portions of manhole, including base slab projections.
- II.1.3.5. Internal liquid pressure based on unit weight of 63 pcf.
- II.1.3.6. Dead load of manhole sections fully supported by a polymer concrete manhole base.

#### **II.1.4. STRUCTURE DESIGN**

- II.1.4.1. Polymer Concrete Manhole risers, cones, flat lids, grade rings and manhole base sections shall be designed by manufacturer to meet the intent of ASTM C 478 with allowable compositional and sizing differences as designed by the polymer concrete manufacturer.
- II.1.4.2. Polymer Concrete Mix Design shall consist of thermosetting resin, sand, and aggregate. No Portland cement shall be allowed as part of the mix design matrix. All sand and aggregate shall be inert in an acidic environment.
- II.1.4.3. Reinforcement shall be acid resistant reinforcement (FRP Bar) in accordance with ACI 440.1R-06 as applicable for polymer concrete design.
- II.1.4.4. The wall thickness of polymer concrete structures shall not be less than that prescribed by the manufacturer's design by less than 95% of stated design thickness.
- II.1.4.5. Thermosetting Resin - The resin shall have a minimum deflection temperature of 158° F when tested at 264 psi (1.820 mPa) following Test Method D 648. The resin content shall not be less than 7% of the weight of the sample as determined by test method D-2584. Resin selection shall be suitable for applications in the corrosive conditions to which the polymer concrete manhole structures will be exposed.
- II.1.4.6. Each polymer concrete manhole component shall be free of all defects, including indentations, cracks, foreign inclusions and resin starved areas that, due to their nature and degree or extent, detrimentally affect the strength and serviceability of the component part. Cosmetic defect shall not be cause for rejection. The nominal internal diameter of manhole components shall not vary more than 2%. Variations in height of two opposite sides of risers and cones shall not be more than 5/8 inch. The under run in height of a riser or cone shall not be more than ¼ in/ft of height with a maximum of ½ inch in any one section.

# *JEA Water and Wastewater Standards*

## *427 Wastewater Manholes*

- II.1.4.7. Marking and Identification - Each manhole shall be marked with the following information - Manufacturer's name or trademark, Manufacturer's location and Production Date.
- II.1.4.8. Manhole joints shall be assembled with a bell/spigot or shiplap butyl mastic and/or gasketed joint so that on assembly, manhole base, riser and top section make a continuous and uniform manhole. Joint sealing surfaces shall be free of dents, gouges and other surface irregularities that would affect joint integrity.
- II.1.4.9. Minimum clearance between wall penetrations and joints shall be per manufacturer's design.
- II.1.4.10. Construct invert channels to provide smooth flow transition with minimal disruption of flow at pipe- manhole connections. Invert slope through manhole is as indicated on drawings. All precast base sections to be cast monolithically. Polymer bench and channel are to be constructed with all polymer concrete material. In the event that the manhole bench and invert are to be hand built, utilizing traditional brick and Portland cement mortar, after curing, all Class "C" concrete benches, channels, and inverts shall be coated with an approved epoxy coating. Coating shall be applied to all cold joints between horizontal and vertical surfaces, continuing a minimum of six (6") inches up the vertical surface. Extended ballast slab requirements for buoyancy concerns can be addressed with cementitious concrete material.
- II.1.4.11. Provide resilient connectors conforming to requirements of ASTM C 923. All connectors are to be water tight. Install approved resilient connectors at each pipe entering and exiting manholes in accordance with manufacturer's instructions.

### II.1.5. QUALITY CONTROL

Facility Quality Control shall be maintained by adhering to ISO 9001:2008 for manufacturing. All fabricators will be ISO 9001:2008 Certified. All fabrication will take place in an all polymer concrete fabrication facility. At no time will the polymer concrete fabrication facility share the facility with a cementitious precast product production facility. Fabricator is also to provide references of 5 previous projects in the last 5 years performed with both owner and contractor for reference and review by owner. Polymer concrete shall be cast in a polymer only facility and shall not be manufactured in a cementitious concrete facility.

### II.1.6. GROUTING

All materials needed for grouting and patching will be a polyester mortar compound provided by the manufacturer or an approved equal by the manufacturer. All holes in sections used for handling and annular spaces, around influent and effluent pipes, shall be filled using the material listed above AND coated with a manufacturer approved compatible epoxy coating.

## II.2. PRECAST CONCRETE WASTEWATER MANHOLES

### II.2.1. GENERAL REQUIREMENTS

- II.2.1.1. Reference the Manhole Application Table above for allowed installation locations.
- II.2.1.2. Wastewater manhole bases, sections and cones shall conform to the requirements of ASTM C478, "Specification for Precast Reinforced Concrete Manhole Sections" with

# *JEA Water and Wastewater Standards*

## *427 Wastewater Manholes*

the exception of Section 10(a), except as modified herein. Cement shall meet the requirements of ASTM C150, "Specification for Portland Cement Type H". Concrete shall meet the minimum requirements for Class "A" as specified in Chapter II. 5. - Section 437- Concrete Work.

II.2.1.3. Minimum wall thickness shall be 1/12 the inside diameter of the manhole in inches plus 1 inch.

II.2.1.4. If requested by JEA, the required minimum strength of concrete shall be confirmed by making and testing 4 standard cylinders at seven days in accordance with Chapter IV. 1. - Section 437- Concrete Work.

II.2.1.5. Rings shall be custom-made with openings to meet indicated pipe alignment conditions and invert elevations.

II.2.1.6. Bases for concrete manholes shall be cast integrally with the bottom manhole section.

### **II.2.2. JOINTS**

Joints shall be tongue and groove configuration formed with machined castings. Joint surfaces shall be as detailed on JEA Standard Details. The joint shall be sealed using an approved pre-molded plastic joint sealer. Prior to placement of the joint sealer, the joint surfaces shall be primed in accordance with the recommendations of the sealer manufacturer. Joints shall be watertight. Upon completion of installation, excess joint sealers shall be trimmed flush with the inside and outside surface of the manhole.

### **II.2.3. EXTERIOR JOINT SEALANT MEMBRANE**

All exterior joints including the top cone section, of precast concrete manholes (including base and risers sections) shall be sealed with one 6-inch wide (minimum) exterior joint sealant membrane centered on joint. The tape shall be capable of sealing manhole joints against groundwater and sand infiltration. The installation of the membrane shall be in conformance with the recommendations of the manufacturer. Surface must be smooth, clean, dry and free of voids, loose aggregate, dirt or other matter that will hinder the adhesion of the membrane. A primer shall be used in accordance with the recommendations of the membrane manufacturer. If recommended by the manufacturer, heat shall be applied to all areas being sealed. See Approved Materials Manual for a list of approved tape manufacturers.

### **II.2.4. COATING FOR MANHOLES CONSTRUCTED WITH PORTLAND CONCRETE**

The interior and exterior surfaces of each concrete manhole, including adjusting rings, shall be given 2 coats of bitumastic coating. Total minimum dry film thickness shall be 12 mils. Each coat shall be applied at a rate not to exceed one gallon per 100 square feet. In lieu of a bitumastic coating, an acrylic polymer base coating may be applied on all areas listed above. Three coats of acrylic polymer base coating shall be used with a total dry film thickness of 3.5 mils. The waterproofing materials shall be applied by brush or spray and in accordance with the instructions of the manufacturer. Time shall be allowed between coats to permit sufficient drying so that the application of the additional coat has no effect on the previous coat. Field applications of coatings for precast structures are not acceptable, but are acceptable for applicable field repairs only. Any manhole designated by the JEA representative as requiring corrosion resistance shall be coated internally as outlined in Chapter IV. 6. - Section 446-Specialty Coatings and Linings instead of the



# *JEA Water and Wastewater Standards*

## *427 Wastewater Manholes*

interior bitumastic coating. The exterior of all manholes shall receive the bitumastic coating as specified above.

### **II.2.5. PVC SAND SLEEVE**

The PVC sleeve shall have the same SDR rating as the connecting pipe (SDR- 26 at a minimum). The outside surface shall have a rough building sand finish. No internal pipe stop is required. A minimum of one internal rubber gasket is required.

### **II.2.6. FLEXIBLE MANHOLE CONNECTOR (RUBBER BOOT)**

As an alternate method of connecting the wastewater pipe to the precast concrete manhole, a flexible pipe to manhole connector may be used. The connector shall be the sole element to assure a flexible watertight seal of the pipe to the manhole.

### **II.2.7. GROUTING**

All materials needed for grouting and patching shall be a polyester mortar compound provided by the manufacturer or an approved equal by the manufacturer. All holes in sections used for handling and annular spaces, around influent and effluent pipes, shall be filled using the material listed above AND coated with a manufacturer approved compatible epoxy coating.

## **II.3. FIBERGLASS WASTEWATER MANHOLES**

### **II.3.1. GENERAL REQUIREMENTS**

II.3.1.1. Reference the Manhole Application Table above for approved locations.

II.3.1.2. Fiberglass reinforced polyester manhole shall be manufactured from commercial grade unsaturated polyester resin with fiberglass reinforcements. Manhole shall be a one-piece unit manufactured to meet or exceed all specifications of ASTM D3753. Fiberglass manhole shall be designed for H-20, traffic applications (withstand 40,000 lb wheel load) minimum.

### **II.3.2. DESIGN**

#### **II.3.2.1. Resin**

The resins used shall be a commercial grade unsaturated polyester resin.

#### **II.3.2.2. Reinforcing Materials**

The reinforcing materials shall be commercial Grade "E" type glass in the form of mat, continuous roving, and chop roving, having a coupling agent that will provide a suitable bond between the glass reinforcement and the resin.

#### **II.3.2.3. Interior Surface**

The inner surface exposed to the chemical environment shall be a resin-rich layer of 0.010 to 0.020 inches thick. The inner surface layer exposed to the corrosive environment shall be followed with a minimum of two passes of chopped roving of minimum length 0.5 inches (13 mm) to maximum length of 2.0 inches (50.8 mm) and shall be applied uniformly to an equivalent weight of 3 oz/ft<sup>2</sup>. Each pass of chopped roving shall be well-rolled prior to the application of additional reinforcement. The

# *JEA Water and Wastewater Standards*

## *427 Wastewater Manholes*

combined thickness of the inner surface and interior layer shall not be less than 0.10 inches (2.5 mm).

### II.3.2.4. Wall Construction Procedure

After the inner layer has been applied, the manhole wall shall be constructed with a chop and continuous strand filament wound manufacturing process which insures continuous reinforcement and uniform strength and composition. The cone section, if produced separately, shall be affixed to the barrel section at the factory with a resin-glass reinforced joint resulting in a one piece unit. Seams shall be fiberglass on the inside and the outside using the same glass-resin jointing procedure. Field joints shall not be acceptable.

### II.3.2.5. Exterior Surface

For a UV inhibitor the resin on the exterior surface of the manhole shall have gray pigment added for a minimum thickness of .125 inches. The exterior surface shall be relatively smooth with no sharp projections. Hand-work finish is acceptable if enough resin is present to eliminate fiber show. The exterior surface shall be free of blisters larger than 0.5 inches in diameter, delaminating or fiber show.

### II.3.2.6. Interior Surface

The interior surface shall be resin rich with no exposed fibers. The surface shall be free of crazing, delaminating, blisters larger than 0.5 inches in diameter and wrinkles of 0.125 inches or greater in depth. Surface pits shall be permitted if they are less than 0.75 inches in diameter and less than 0.0625 inches deep. Voids that cannot be broken with finger pressure and that are entirely below the resin surface shall be permitted if they are less than 0.5 inches in diameter and less than 0.0625 inches thick.

### II.3.2.7. Stub-outs and Connections

Stub-outs must be installed per manufacturer's instruction. Installation of smooth exterior PVC wastewater pipe must be performed by sanding, priming, and using resin fiber-reinforced hand lay-up. The resin and fiberglass shall be the same type and grade as used in the fabrication of the fiberglass manhole. Special fittings or boots may be installed by manhole manufacturer.

### II.3.2.8. Manhole Bottom

When indicated on the drawings, manholes shall have resin fiber- reinforced bottoms. Bottom shall have a minimum of three 1½ inch deep x 3½ inch wide stiffening ribs completely enclosed with resin fiber-reinforcement and have a minimum of 3 inch anti-flotation ring. Manhole bottom shall be a minimum of 5/16 inches thick.

### II.3.2.9. Fillers and Additives

Fillers, when used, shall be inert to the environment and manhole construction. Sand shall not be accepted as an approved filler. Additives, such as thixotropic agents, catalysts, promoters, etc., may be added as required by the specific manufacturing process to be used to meet the requirements of this standard. The resulting reinforced-plastic material must meet the requirements of this specification.

### II.3.2.10. Grouting

# JEA Water and Wastewater Standards

## 427 Wastewater Manholes

All materials needed for grouting and patching shall be a polyester mortar compound provided by the manufacturer or an approved equal by the manufacturer. All holes in sections used for handling and annular spaces, around influent and effluent pipes, shall be filled using the material listed above AND coated with a manufacturer approved compatible epoxy coating.

### II.3.3. DESIGN PROPERTIES

#### II.3.3.1. Interior Access

All manholes shall be designed so that a ladder or step system can be supported by the installed manhole.

#### II.3.3.2. Manway Reducers

Manway reducers will be concentric with respect to the larger portion of the manhole diameters through 60 inches. Larger manholes may have concentric or eccentric manway reducer openings.

#### II.3.3.3. Cover and Ring Support

The manhole shall provide an area from which a typical ring and cover plate can be supported without damage to the manhole (32 inch opening).

#### II.3.3.4. Manhole Lengths

Manhole lengths shall be in 6 inch increments +/- 2 inches.

#### II.3.3.5. Diameter Tolerance

Tolerance of inside diameter shall be +/- 1% of required manhole diameter.

#### II.3.3.6. Physical Requirements

##### II.3.3.6.1. Physical Properties

	Hoop Direction	Axial Direction
Tensile Strength (psi)	18,000	5,000
Tensile Modules (psi)	0.6 x 10 <sup>6</sup>	0.7 x 10 <sup>6</sup>
Flexural Strength (psi)	26,000	4,500
Flexural Modules (psi)	1.4 x 10 <sup>6</sup>	0.7 x 10 <sup>6</sup>
Compressive (psi)	18,000	12,000

##### II.3.3.6.2. Load Rating

The complete manhole shall have a minimum dynamic-load rating of 16,000 lbs. When tested in accordance with ASTM D3753 8.4 (note 1).

# JEA Water and Wastewater Standards

## 427 Wastewater Manholes

To establish this rating the complete manhole shall not leak, crack or suffer other damage when load tested to 40,000 lbs. and shall not deflect vertically downward more than 0.25 inch at the point of load application when loaded to 24,000 lb.

### II.3.3.6.3. Stiffness

The manhole cylinder shall have the minimum pipe- stiffness values shown in the table below when tested in accordance with ASTM D3753 8.5 (note 1).

Manhole Length (ft)	Pressure (psi)
3 – 6.5	0.75
7 – 12.5	1.26
13 – 20.5	2.01
21 – 25.5	3.02
26 – 35	5.24

### II.3.3.6.4. Soundness

In order to determine soundness, apply an air or water pressure test to the manhole test sample. Test pressure shall not be less than 3 psig or greater than 5 psig. While holding at the established pressure, inspect the entire manhole for leaks. Any leakage through the laminate is cause for failure of the test. Refer to ASTM D3753 8.6.

### II.3.3.6.5. Chemical Resistance

When tested in accordance with ASTM D3753 8.7 the log of percent retention of each property after immersion testing when plotted against the log of immersion time, and extrapolated to 100,000 hours, shall assure retention of at least 50% of initial properties.

### II.3.3.6.6. Required Wall Thickness

Assumptions: Hoop Modulus = 4,000,000 psi  
Soil Modulus = 1000 psi (minimum)

Diameter (Inches)	Wet Soil Depth (max) (Feet)	Minimum Thickness (Inches)
48	10	.25
	20	.3125
	30	.375
60	10	.375

# JEA Water and Wastewater Standards

## 427 Wastewater Manholes

	20	.4375
	30	.50
72	10	.4375
	20	.50
	30	.5625
96	10	.5625
	20	.625
	30	.75

### II.3.3.6.7. Test Methods

All tests shall be performed as specified in ASTM D3753 Section 8. Test method D-790 (see note 5) and test method D-695.

### II.3.3.6.8. Certification

As a basis of acceptance, the manufacturer shall provide an independent certification which consists of a copy of the manufacturer's test report and a copy of the test results that the manhole has been sampled, tested and inspected in accordance with the provision of this specification and meets all requirements.

### II.3.3.6.9. Marking and Identification

Each manhole shall be marked on the inside and outside with the following information:

- Manufacturer's Name or Trademark
- Manufacture Factory Location
- Manufacture Serial Number
- Total Length

## II.4. WASTEWATER MANHOLE FRAME AND COVER

Wastewater Manhole frames and covers shall be cast iron of the type as shown in JEA Standard Details and as listed within JEA Approved Materials Manual. Manhole cover shall be 32 inches in diameter.

### II.4.1. CASTINGS

Castings shall be even grained cast iron and shall be smooth, free from scale, lumps, blisters, sand holes and defects of any nature that would render them unfit for the service for which they are intended. They shall be thoroughly cleaned. Castings shall meet the requirements of ASTM A48, "Specifications for Gray Iron Castings, Class No. 30, or Grade 65-45-12" and Ductile Iron meeting the requirements of ASTM A536, "Standard Specification for Ductile Iron Castings".

### II.4.2. TRAFFIC LOADING

# *JEA Water and Wastewater Standards*

## *427 Wastewater Manholes*

Manhole frame and cover shall be designed to withstand an HS20-44 loading defined in the AASHTO Specifications.

### **II.4.3. SEATING**

Frames and covers shall be machined or ground at touching surfaces to seat firmly and prevent rocking. Any set not matching perfectly shall be removed and replaced at no additional cost. A neoprene gasket shall be an integral part of the cover to provide a watertight seal. Cover shall set flush with rim of frame and shall have no larger than a 1/8 inch gap between frame and cover.

## **II.5. ADJUSTMENT RINGS (MANHOLE COLLARS)**

Adjustment rings shall be 8" wide (48" OD X 32" diameter opening) concrete.

### **II.5.1. CONCRETE ADJUSTMENT RINGS**

Concrete adjustment rings shall be 4000 psi (minimum) concrete, Type II cement. Minimum height of rings shall be 2 inches. Rings shall be grouted in place. Concrete mortar (1/2" thick) shall be applied to the interior and exterior surfaces of the concrete adjustment rings. The interior of the concrete ring shall be coated as specified above. In lieu of precast concrete rings, bricks may also be utilized (mortar in place) with 1/2 inch thick mortar layer on interior and exterior surfaces.

### **II.5.2. HIGH DENSITY POLYETHYLENE RINGS**

High Density polyethylene (HDPE) rings may be utilized for manholes located in non-traffic areas only (not in streets, parking areas, drive ways etc.). HDPE adjustment rings shall be stackable and have a minimum height of 2 inches and be installed with silicone sealant as per the manufacturer's directions. Apply heavy amount (covering the entire joining surfaces) of silicone sealant between the manhole cone section and HDPE rings, between all stackable rings and between HDPE ring and manhole frame (note: do not use concrete grout during the assembly of HDPE rings). During the installation of HDPE rings, the contractor shall apply downward pressure on the rings to squeeze out the excess silicone (tight fit).

## **III. INSTALLATION**

### **III.1. PRECAST POLYMER AND CONCRETE WASTEWATER MANHOLES**

#### **III.1.1. SETTING WASTEWATER MANHOLE BASES**

Wastewater Manhole bases shall be set level on bedding consisting of 12 inches (at a minimum) of granular material (57 stone) as detailed in the JEA Water and Wastewater Details. For all manholes deeper than ten (10) feet (from the finish elevation to the invert), the Contractor shall be required to schedule the JEA representative to attend and observe/inspect the bedding foundation prior to the base being set. The JEA representative shall provide written "no objection" to the Contractor for the setting of the manhole base.

#### **III.1.2. INSTALLING MANHOLE SECTIONS**

III.1.2.1. During the handling of all manholes, the contractor shall protect the manhole and not allow a chain, cable or other lifting line to damage the joint surfaces. Spreader bars, wood blocks or other devices shall be utilized to prevent damage to the manhole. Any manhole section found to have defects, included but not limited to leaks and cracks shall be removed and replaced.

## *JEA Water and Wastewater Standards*

### *427 Wastewater Manholes*

- III.1.2.2. The manhole sections shall be set so the manhole will be vertical and with section in true alignment. Construction shall include:
- III.1.2.2.1. Cleaning all joint surfaces (remove all sand, oil, debris & other foreign items) and provide additional primer if recommended by the joint manufacturer.
  - III.1.2.2.2. The joint sealant (JEA Standards approved joint sealant) and the manhole surfaces shall be dry during the installation period (shall not be installed if wet or during rain events).
  - III.1.2.2.3. Joint sealant is applied to both the top & bottom joint surfaces (Double Ring Method). The joint sealant shall be installed continuously around all joints with the ends placed butt to butt (not overlapped & no open gaps between sealants).
  - III.1.2.2.4. The excess joint sealant shall be trimmed flush to the inside surfaces of the manhole. Trim the outside surfaces if an exterior joint sealant/tape is applied.
  - III.1.2.2.5. Apply a special primer and an "Exterior Joint Sealant Membrane" to the outside surfaces of all manhole joints/seams which are located below the top cone section. Apply the primer and joint membrane in accordance with the recommendations of the membrane manufacturer.
  - III.1.2.2.6. Manholes with leaking joints (infiltration of ground water) will not be accepted by JEA. JEA will not accept leak repairs on new construction of manholes. The leaking manhole is to be removed and replaced.
  - III.1.2.2.7. The gravity wastewater pipes and rubber boots shall be clean and lubricated during assembly to provide for a leak free connection at the manhole. To protect the inside surfaces of the rubber manhole boots, an epoxy packing (not regular concrete) coated with an approved compatible epoxy coating shall be applied to the void/open areas around the boot. All rubber boots observed to be leaking shall be removed and replaced by the Contractor prior to final acceptance by JEA. No repair shall be allowed. All cost for removal and replacement shall not be paid for separately but shall be merged with the associated item of work.
  - III.1.2.2.8. All holes in sections used for handling and the annular space between the wall and entering pipes shall be thoroughly plugged with JEA Standards approved epoxy packing grout applied and cured in strict conformance with the manufacturer's recommendations so that there will be zero leakage through openings and around pipes. The grout shall be finished smooth and flush with the adjoining interior and exterior manhole wall surfaces. Coat grout on the interior and exterior surfaces with an approved compatible epoxy coating as specified above.

### III.1.3. SETTING WASTEWATER MANHOLE FRAMES AND COVERS

# *JEA Water and Wastewater Standards*

## *427 Wastewater Manholes*

- III.1.3.1. For grade adjustment in setting the manhole frame, adjustment rings shall be used on top of manhole slabs and manhole cones in accordance with the drawings.
- III.1.3.2. Wastewater manhole frames and covers shall be set to conform accurately to the finished ground or pavement surface as established by the Contract Drawings, unless otherwise directed by the Engineer and approved by JEA. Frames on manhole cones shall be set concentric with the masonry and in a full bed of mortar so that the space between the top of the manhole and the bottom flanges of the frame shall be completely filled and made water tight. A ring of mortar at least 1-inch thick and pitched to shed water away from the frame shall be placed around the outside of the bottom flange. Mortar shall extend to the outer edge of the concrete adjustment rings and shall be finished smooth and flush with the top of the flange.
- III.1.3.3. The neoprene gasket on the underside of the manhole cover shall be protected from damage during the construction period. Should the gasket be damaged, it shall be repaired by the contractor in accordance with the manufacturer's recommendation. The condition of all neoprene gaskets shall be inspected for damage during the final inspection of the project. Damaged gaskets/covers will not be accepted by JEA.

### **III.2. FIBERGLASS WASTEWATER MANHOLES**

#### **III.2.1. GENERAL**

Installation shall be in accordance with the JEA Standards, Details, and Materials Manual and manufacturer's recommendations.

#### **III.2.2. SHIPPING AND HANDLING**

The fiberglass wastewater manhole shall not be dropped or impacted. Fiberglass wastewater manhole may be lifted by inserting a 4" x 4" x 30" timber into the top of the manhole with cable attached or by a sling or "choker" connection around center of manhole. Use of chains or cables in contact with the manhole surface is prohibited.

#### **III.2.3. BACKFILL**

##### **III.2.3.1. Backfill Material**

Unless shown otherwise on drawings and approved by the Engineer, sand, crushed stone, or pea gravel shall be used for backfill around the manhole for a minimum distance of one foot from the outside surface and extending from the bottom of the excavation to the top of the reducer section. Suitable material chosen from the excavation may be used for the remainder of the backfill. The material chosen shall be free of large lumps or clods, which will not readily break down under compaction. This material will be subject to approval by the Engineer.

##### **III.2.3.2. Backfill Procedure**

Backfill shall be placed in layers of not more than 12 loose inches and mechanically tamped to 95% Standard Proctor Density, unless otherwise approved by the Engineer. Flooding will not be permitted. Backfill shall be placed in such a manner as to prevent any wedging action against the fiberglass manhole structure.

#### **III.2.4. CONCRETE**



# *JEA Water and Wastewater Standards*

## *427 Wastewater Manholes*

Concrete may be used to form bench area and invert. Concrete may also be used on top of anti-flotation ring and around reducer section as required for buoyancy.

### **III.2.5. CONCRETE BOTTOM**

Lower manhole into wet concrete until it rests at the proper elevation, with a minimum of 4 inches of fiberglass manhole inserted into the wet concrete below flow line, then move manhole to plumb. The concrete shall extend a minimum of one foot from the outside wall of the manhole and a minimum of 6 inches above incoming lines. On the inside, concrete shall form the bench and invert area and rise a minimum of 4 inches above incoming lines. If required by Engineer, concrete may be used around reducer section for buoyancy.

### **III.2.6. REPAIRS**

Any manhole repair is required to meet all requirements of this specification.

### **III.2.7. FLOW CHANNELS**

Flow channels in the manhole base shall be formed of Class "C" concrete, while the manhole is under construction. Flow channels shall be solid concrete or concrete with solid filler blocks. No rubble shall be allowed. Cut off pipes at inside face of the manhole and construct the invert to the shape and size of pipe indicated. All inverts shall follow the grade of the pipe entering the manhole. A change in direction of the wastewater and entering branch or branches shall be laid out in smooth curves of the longest possible radius which is tangent to the center lines of adjoining pipelines. After curing, all Class "C" concrete benches, channels, and inverts shall be coated with an approved epoxy coating. Coating shall be applied to all cold joints between horizontal and vertical surfaces, continuing a minimum of six (6") inches up the vertical surface.

### **III.2.8. DROP INLETS**

Where shown on the drawings, drop inlets to the manhole shall be constructed as shown on the JEA Standard Details and specified herein.

### **III.2.9. CONNECTIONS TO EXISTING STRUCTURES**

The Contractor shall core suitable openings using a coring machine, jigsaw or hole saw into the existing structure or remove the existing pipe to accommodate the pipelines as indicated on the Contract Drawings and as specified. The portion of each existing structure removed for new installation shall be confined to the smallest opening possible, consistent with the work to be done. Fiberglass manholes shall have the cut out in the wall equal to the outside diameter of pipe, plus ½ inch maximum. The connection to existing manhole shall comply with wastewater detail S-15.

### **III.2.10. REPAIRS TO CONCRETE STRUCTURES**

After the pipe is installed the Contractor shall carefully close up the openings around the pipe, using an approved epoxy packing grout and repair the existing structure invert, if necessary, in a manner satisfactory to the Engineer. If the existing structure has a specialty coating, repair that coating using coating manufacturer's product and installation requirements. See Chapter IV. 6. - Section 446 - "Specialty Coatings and Linings".

### **III.2.11. REPAIR TO FIBERGLASS STRUCTURES**

Grind the outside surface of the pipe and both the inside and the outside surfaces of the cutout in the structure wall. Apply a priming agent to any PVC pipe that might be used before fiberglass lay-up. Insert the pipe through the cutout in the wall. Apply fiberglass putty to the inside and the outside

# *JEA Water and Wastewater Standards*

## *427 Wastewater Manholes*

of the wall cutout, filling openings between pipe and cutout. Make a good radius for the fiberglass lay-up. After the putty has set up, fiberglass the pipe into place. Use one layer of woven roving sandwiched between two layers of fiberglass mat. Allow fiberglass to completely set up before backfilling. Manufacturer of structure shall be responsible for integrity of field glassing.

### **III.3. MANHOLE INSPECTION**

#### **III.3.1. PHYSICAL INSPECTION**

All manholes shall be inspected for leaks and any defects that may cause infiltration, or weaken the structural integrity. Before the final inspection, manholes shall be trimmed of any excess Ram-Nek joint sealant. Any voids in pre-cast manhole shall be filled with non-shrink grout and the grouted areas shall be thoroughly field coated (2 coats) with bituminous waterproofing excluding invert and bench, as required. The gasket on the manhole cover shall be inspected for cuts, tears, scraps and proper fit. If found damaged, the entire gasket seal shall be replaced in accordance with the manufacturer's recommendation, at contractor's expense.

#### **III.3.2. ELECTRONIC INSPECTION**

Contractor shall be required to televise the interior of each new and/or replacement manhole utilizing a pole mounted type camera. Televising of the manhole structures to occur when gravity wastewater mains are CCTV'd, and in the presence of JEA representative. Results shall be observed by the JEA representative on the CCTV color monitor used for viewing the associated wastewater main. Interior manhole structure to be televised shall be free of debris prior to inspection. Each manhole shall be identified on the DVD and report (both to be copied and delivered to JEA for review and its files) by manhole number and nearest address/intersection or by as-built station number/offset. Manhole to be televised shall require review of frame, cone, risers, joints, bench, flow channel, and each pipe connection.

### **IV. MANHOLE ABANDONMENT AND REMOVAL**

#### **IV.1. MANHOLE ABANDONMENT**

Wastewater manhole abandonment shall be in accordance with Chapter II. 2. - Section 407, 'Demolition and Abandonment'.

#### **IV.2. MANHOLE REMOVAL OR REPLACEMENT**

Removal of existing manholes shall include the complete removal of said manholes where so noted on the contract drawings.

##### **IV.2.1. REMOVAL ONLY**

Where no new structure is designated to replace the removed manhole, the void, left by the manhole removal shall be filled and compacted in accordance with Chapter II. 3. - Section 408-Excavation and Earthwork.

##### **IV.2.2. REMOVE AND CONSTRUCT**

Where a new structure is designated to replace an existing manhole, complete removal of the existing manhole shall be achieved so as to permit the construction of a new manhole at approximately the same location.

##### **IV.2.3. DISPOSAL OF STRUCTURES**

*JEA Water and Wastewater Standards*  
*427 Wastewater Manholes*

The existing manhole to be removed shall be removed from the site. The rubble shall be disposed of without damage to any of the new or existing facilities at the site. The debris shall be hauled to a disposal site to be designated or approved by the Engineer.

# JEA Water and Wastewater Standards

## 427 Wastewater Manholes

### V. MANHOLE INSPECTION CHECKLIST

Project Name: \_\_\_\_\_

Street/Intersection/Address Location: \_\_\_\_\_

Availability Number: \_\_\_\_\_ Project Number: \_\_\_\_\_ MH Number: \_\_\_\_\_

Date/Time: \_\_\_\_\_

STA: \_\_\_\_\_ Offset: \_\_\_\_\_

Frame:	<input type="checkbox"/>	At finished grade
	<input type="checkbox"/>	Below finish grade - adjust per spec
Manhole cover:	<input type="checkbox"/>	JEA logo w/ neoprene gasket
	<input type="checkbox"/>	Not JEA logo w/ neoprene gasket - Provide lid
Manhole cover gap (between frame and cover):	<input type="checkbox"/>	Range of gap no larger than 1/8 inch
	<input type="checkbox"/>	Range of gap larger than 1/8 inch - Fix
Frame condition:	<input type="checkbox"/>	Good
	<input type="checkbox"/>	Cracked/broken - provide replacement
	<input type="checkbox"/>	Offset - needs resetting/re-grouting
Adjustment rings grouted/sealed in place:	<input type="checkbox"/>	Yes
	<input type="checkbox"/>	No - provide per spec
Wall condition:	<input type="checkbox"/>	Good
	<input type="checkbox"/>	Damaged/cracks/holes/leaking joints - see spec
2 coats of bituminous waterproofing from frame to base:	<input type="checkbox"/>	Yes
	<input type="checkbox"/>	No, lined, fiberglass or polymer concrete
	<input type="checkbox"/>	No - provide per spec
Inside drop assembly stainless steel located vertically at 4 feet max.:	<input type="checkbox"/>	Yes
	<input type="checkbox"/>	No - provide per detail
Constructed flume formed for Inside drop < 2 feet:	<input type="checkbox"/>	Yes
	<input type="checkbox"/>	No - provide per detail
	<input type="checkbox"/>	N/A
Pipe seal:	<input type="checkbox"/>	Good, coated with epoxy coating
	<input type="checkbox"/>	Leaking - remove & replace per spec
Bench condition:	<input type="checkbox"/>	Good, solid bench per tap test
	<input type="checkbox"/>	Cracked/broken - provide repair per spec
	<input type="checkbox"/>	Clean free of debris

***JEA Water and Wastewater Standards***  
***427 Wastewater Manholes***

Flow channel condition:	<input type="checkbox"/>	Coated with epoxy coating
	<input type="checkbox"/>	Invert formed
	<input type="checkbox"/>	No invert formed/cracks/broke - repair per spec
Flow channel hydraulics:	<input type="checkbox"/>	Good, clean free of debris
	<input type="checkbox"/>	Uneven shape/radius/standing water - repair per spec.

Contractor Representative: \_\_\_\_\_  
Signature & Printed Name

JEA Inspector: \_\_\_\_\_  
Signature & Printed Name

JEA O&M representative: \_\_\_\_\_  
Signature & Printed Name

Commissioned this date: \_\_\_\_\_

## **428 - GRAVITY SEWERS**

### **I. GENERAL REQUIREMENTS**

#### **I.1. SCOPE OF WORK**

The Contractor shall furnish and install all gravity wastewater lines, fittings, and appurtenances required for a complete system as shown on the drawings and specified herein. The work shall also include such connections, reconnections, temporary service, and all other provisions in regard to existing wastewater operations and modifications as is required to perform the new work. All references to Industry Standards (ASTM, ANSI, AWWA, etc.) shall be to the latest revision unless otherwise stated. Only those materials included in the JEA Water and Wastewater Standards Manual shall be installed. All materials shall be new unless specifically called for otherwise.

#### **I.2. PROJECT SCHEDULE AND COOPERATION**

The project schedule shall be established on the basis of working a normal work schedule including five days per week, single shift, eight hours per day, or four days per week, single- shift, ten hours per day. Unless approved otherwise by JEA, normal or general items of work, such as T-V inspections, density testing and final inspections, shall be scheduled during the normal work schedule. Due to operational and manpower limitations on the JEA systems, JEA will require the contractor to perform work outside of the normal work schedule. These operational and manpower limitations, including but not limited to, tie-in work (cut-in work or other tie-in work) and other phases of the work which may impact the continued (non-interruptible) service to existing JEA customers. The contractor shall plan and anticipate the cost impact of these system limitations and provide such work or services at no additional cost to JEA.

#### **I.3. SHOP DRAWING SUBMITTALS:**

Actual catalog data, brochures and descriptive literature will not be required for items of standard usage which meet the requirements of Chapter X. and Chapter XI. of the JEA Water and Wastewater Standards Manual. Any specialty item not shown in this manual will require a complete shop drawing submittal. The Engineer may at any time require the Contractor to provide a complete detailed shop drawing submittal for any material which, in the Engineer's opinion, may not be in compliance with the JEA Water and Wastewater Standards.

#### **I.4. AS-BUILT DRAWING**

As-built drawings are required on all water, wastewater, reclaimed water and chilled water projects, including projects for JEA, City of Jacksonville, JTA, DOT, private developments, (utilities to be dedicated to JEA), and other City Authorities, etc. As-built drawings shall be in accordance with specification Section 501, entitled "As-Built Drawings". As built drawings shall be reviewed and approved by JEA. The cost to provide as-built drawings shall be included as part of the related work requirements or general conditions for the utility work. In addition, as-built drawings are required which meet current regulatory rules regarding "certification of completion".

#### **I.5. CONTRACTOR WARRANTY**

The Contractor shall supply to JEA a two (2) year unconditional warranty. The warranty shall include materials and installation and shall constitute complete replacement and delivery to the site of materials and installation of same to replace defective materials or defective workmanship with new materials/workmanship conforming to the specifications.

# JEA Water and Wastewater Standards

## 428 Gravity Sewers

### II. MATERIALS

All material shall be free from defects impairing strength and durability, shall be of the best commercial quality for the purpose specified, shall have structural properties sufficient to safely sustain or withstand strains and stresses to which it is normally subjected and be true to detail.

#### II.1. PIPE

Pipe for gravity sewage lines shall be polyvinyl chloride (PVC) as shown on the drawings and as herein specified. Pipe to be installed underground shall be PVC push-on joint type. Pipe installed above ground shall be welded Stainless Steel pipe or flanged Stainless steel pipe as described in these specifications. PVC pipe shall not be used in above ground applications. The "depth of cut" shall be defined as the vertical distance from pipe invert to finish grade. For pipe bursting construction, the pipe shall be high density polyethylene (HDPE, grey color with green strip) with a DR-17 rating. See Chapter VI. 2. - Section 750 for additional material requirements. Pipe and fittings sizes and applications shall conform to the following chart.

PIPE & FITTINGS	PIPE SIZE	JOINT TYPE	ACCEPTABLE BURY DEPTHS	APPLICATION
PVC DR18	6 inches and larger	Push-on joint	Refer to note 1 and 2	<ul style="list-style-type: none"> <li>• Gravity main</li> <li>• Laterals</li> <li>• Jack &amp; bore carrier</li> </ul>
PVC SDR26	6 inches and larger	Push-on joint	Refer to note 1 and 2	<ul style="list-style-type: none"> <li>• Gravity main</li> <li>• Laterals</li> </ul>
Steel	6 inches and larger	Welded	Refer to note 2	<ul style="list-style-type: none"> <li>• Casing pipe</li> </ul>

Note 1: The maximum "Depth of Cut" shall be no greater than 15 feet for mains without laterals.  
 Note 2: The maximum "Depth of Cut" shall be no greater than 12 feet with laterals.

#### II.1.1. POLYVINYL CHLORIDE (PVC) PIPE

Each length shall be clearly marked with the name of the manufacturer, location of the plant, pressure rating, nominal pipe diameter and length. All PVC sanitary wastewater pipe shall be green. Storage and handling of PVC pipe shall be in accordance with chapter 6 of AWWA Manual M23.

##### II.1.1.1. PVC 1120, CLASS 150, DR18 Pipe

Pipe shall conform to AWWA Standard C900 for 6-inch through 12-inch diameter pipe, and AWWA Standard C905 for 16 inch through 36-inch diameter pipe. All pipe shall be hydrostatically proof tested at the factory in conformance with UNI-B-11 standards. In case of conflict between standards specified herein, the requirements of AWWA Standard C900 and C905 shall prevail. Pipe is to be manufactured to ductile iron pipe equivalent outside diameters. The pipe material shall be clean, virgin, National Sanitation Foundation approved, Class 12454-B PVC compound conforming to ASTM resin specification D1784. Pipe shall be rated for potable water and shall have a bell type coupling with a thickened wall section integral with the pipe barrel in accordance

# *JEA Water and Wastewater Standards*

## *428 Gravity Sewers*

with ASTM D3139. Elastomeric seals shall meet ASTM F477. The pipe shall be designed to pass without failure a sustained pressure test of 500 psi in conformance with ASTM D1598 and a quick burst test of 755 psi in conformance with ASTM D1599.

### II.1.1.2. PVC 1120, CLASS 160, SDR 26 Pipe

Pipe shall conform to ASTM D3034 for sizes 4 inch thru 15 inch diameter pipe and ASTM F679 for 18 inch through 36 inch diameter pipe. The pipe material shall be clean, virgin, National Sanitation Foundation approved, Class 12454-B PVC compound conforming to ASTM resin specification D1784 with wall thickness T-1. Pipe shall have a bell type coupling with a thickened wall section integral with the pipe barrel in accordance with ASTM D3212. Elastomeric seals shall meet ASTM F477 or ASTM F913. The pipe shall be designed to pass without failure a sustained pressure test of 340 psi in conformance with ASTM D1598 and a quick burst test of 400 psi in conformance with ASTM D1599.

## II.1.2. STAINLESS STEEL PIPE

### II.1.2.1. Carrier Pipe

Pipe shall be manufactured from ASTM-A240 annealed and pickled sheets and plates in accordance with ASTM A778 in grade 316L stainless steel. Pipe shall be manufactured to nominal pipe sizes as listed in ANSI B36.19, Table 2. The pipe wall thickness shall be schedule 40 for pipe sizes 8" and smaller and shall be 0.25 inches (min) for pipe sizes 10" and larger. The pipe wall thickness for stainless steel piping at pump stations sites shall be schedule 10. Piping system shall be capable of withstanding satisfactorily all resultant forces exerted by normal pressure conditions, thermal expansion & contraction, and any surge pressures which may arrive from flow reversals during start up or shut down of the system. Fittings may be 316 stainless steel butt weld or flanged type manufactured in accordance with ASTM-A-774 of the same raw material and in the same thicknesses as the pipe. Fittings may also be flanged ductile iron with specialty inside coating. The fittings utilized at wastewater pump station sites shall only be flanged stainless steel (no butt weld fittings) or flanged ductile iron with specialty inside coating. The finish on the raw material, manufactured to ASTM A-240 will be No. 1, HRAP (hot rolled annealed and pickled) or better. The finish on the completed pipe and fittings shall be as specified in ASTM A778 and A774, respectively. Transition from PVC to stainless steel flange to mechanical joint.

### II.1.2.2. Steel Casing Pipe

Pipe to be used as a casing shall conform to either ASTM Standard A139 for "Electric Fusion (arc) Welded Steel Pipe" with minimum yield strength of 35,000 psi or "API Specification API-5LX, Grade X-42 Welded Steel Pipe". Wall thickness shall meet the requirements of the latest Revision of the American Railway Engineering Association Manual of Recommended Practice or the Florida Department of Transportation Standard Specification for Road and Bridge Construction. For street uses which are not DOT or railroad, use DOT casing thickness unless otherwise indicated by Engineer. All pipe furnished by the manufacturer shall be cast and machined at one foundry location to assure quality control and provide satisfactory test data. Full pipe length shall be provided. No short pipe lengths less than 8 feet long will be allowed unless approved by JEA. The pipe ends shall be tapered where welding is required.



# *JEA Water and Wastewater Standards*

## *428 Gravity Sewers*

### **II.2. FITTINGS**

Fittings shall be pressure rated (DR & SDR rated) and have joints that match the type of pipe furnished (at a minimum) except as follows or as otherwise specified. Fittings 6 inches and larger on PVC pipe installed underground shall be of the same PVC type as the pipe with joints to match the pipe being installed. Fittings 6 inches and larger installed above ground shall be ductile iron with flanged ends or restrained joints.

#### **II.2.1. DUCTILE IRON FITTINGS**

Ductile iron fittings shall have a minimum working pressure of 250 psi. Fittings shall conform to ANSI Specification A21.10 (AWWA C110), A21.11 (AWWA C111), A21.15 (AWWA C115) and/or A21.53 (AWWA C153). Fittings shall also be certified by ISO 9000 by an accredited registrar. Compact fittings shall normally be installed. Long body fittings shall be used where the drawings specifically call for long body fittings, where compact fittings are not available, or at the option of the Contractor when the laying length is not controlled by compact fitting patterns. All fittings shall be UL/FM approved and shall conform to NSF Standard 61, as applicable. All fittings furnished by the approved manufacturer shall be cast and machined at one foundry location to assure quality control and provide satisfactory test data. Fittings shall have cast on them the pressure rating, nominal diameter of openings, manufacturer's name, foundry location, plant code and degrees or fraction of the circle. Cast letters and figures shall be on the outside body of the fitting. JEA may require random ductile testing of manufacturer's fittings. All ductile iron fittings shall be externally coated and internally lined as specified in this specification.

#### **II.2.2. POLYVINYL CHLORIDE FITTINGS**

Fittings shall match the type of pipe (pressure rating and joint) and shall conform to the applicable sections of this specification for PVC pipe and PVC joints. The interior finish shall be smooth with no rough edges which may cause line stoppages. Saddle tees or saddle wyes shall not be permitted.

##### **II.2.2.1. PVC 1120, Class 150, DR 18 Fittings**

PVC fittings 4 inches thru 12 inches may be used with PVC C900 pipe. Fittings shall be PVC injection molded, made from materials meeting or exceeding the requirements of cell class 12454-B material as defined in ASTM D1784. All PVC fittings must comply with, or exceed, AWWA C907. All fittings must be designed to the pressure class of DR18, with a pressure rating of 150 psi and a 2.5 to 1 factor of safety. Virgin materials only shall be used in the manufacture of PVC pressure fittings. These fittings must have UL-FM approval and shall comply with or exceed all ASTM Standards for PVC fittings. All fittings must have NSF-61 approval. The elastomeric gasket shall comply with the requirements specified in ASTM F477.

##### **II.2.2.2. PVC 1120, Class 160, SDR 26 Fittings**

Fittings shall be gray in color, meeting the requirements of ASTM D3034 and ASTM F1336 for sizes 4-inch through 15-inch diameter and ASTM F679 and ASTM F1336 for 18 inch through 36-inch diameter with minimum wall thickness of SDR 26. Fittings shall be gasket joint type meeting the requirements of ASTM D3212. Elastomeric gaskets shall conform to ASTM F477 or ASTM F913. PVC material shall have a cell classification of 12454-B in accordance with ASTM D1784.

#### **II.2.3. NON-STANDARD FITTINGS AND WALL CASTINGS**

# *JEA Water and Wastewater Standards*

## *428 Gravity Sewers*

Fittings having non-standard dimensions and cast specifically for this project shall be of approved design. They shall be manufactured to meet the requirements of the same specifications and shall have the same diameter and thickness as standard fittings, but their laying lengths and types of ends shall be determined by their positions in the pipelines and by the particular piping to which they connect. Wall castings shall be of the size and types indicated on the drawings. Flanges, facing, and drilling shall conform to the 125-pound American National Standard. Flanges shall be drilled and tapped for studs. Other dimensions shall be substantially equal to corresponding parts of standard bell and spigot fittings.

### **II.3. JOINTS**

Type of joint used shall be approved by the Engineer prior to installation. Joints shall be made in accordance with approved printed instructions of the manufacturer and shall be absolutely watertight.

#### **II.3.1. MECHANICAL JOINTS**

All jointing materials for mechanical joints shall be provided by the pipe and/or fitting manufacturer. Material assembly and bolting shall be in accordance with ANSI Specification A21.11 (AWWA C111). All glands shall be made of ductile iron only. Mechanical joint gaskets shall be of a composition suitable for exposure to sewage, sludge or scum within the pipe.

#### **II.3.2. PUSH-ON JOINTS**

PVC push-on joints shall have a bell type coupling with a thickened wall section integral with the pipe barrel. Joints for PVC DR18 pipe shall be in accordance with ASTM D3139. Joints for PVC SDR 26 shall be in accordance with ASTM D3212. Elastomeric gaskets shall conform to ASTM F477 for PVC DR 18. Elastomeric gaskets for SDR 26 fittings shall conform to ASTM F477 or ASTM F913.

#### **II.3.3. FLANGED JOINTS**

Ductile iron flanged joints shall conform to ANSI A21.10 (AWWA C110) and ANSI A21.15 (AWWA C115). Flanges shall be in accordance with ANSI Specification B16.1, Class 125 with any special drilling and tapping as required to insure correct alignment and bolting. Screwed flanges shall be screwed in tight at the foundry by machine before they are faced and drilled. Flanges for flanged joints and flanged specials shall be integrally cast at right angles to the axis, accurately faced, and drilled smooth and true. Gaskets shall be rubber ring type, cloth inserted, and a minimum thickness of 1/16 inch and shall be used on all flanges. The entire gasket, including the retainer and sealing ring, shall be one continuous piece. Retainers glued together will not be accepted. Flanged joints shall be made with bolts, bolt studs with a nut on each end, or studs with nuts where the flange is tapped. The number and size of bolts shall conform to the same ANSI standard as the flanges. Bolts and nuts shall be of Grade B conforming to the ASTM A307 Specifications for steel machine bolts and nuts and tap bolts. Bolt studs shall be of the same quality as machine bolts. Bolts shall be tightened so as to distribute evenly the stress in the bolts and bring the pipe in alignment. The contractor shall provide suitable filling rings where the layout of the flange piping is such as to necessitate their use. In materials, workmanship, facing and drilling, such rings shall conform to ANSI B16.1 Class 125.

#### **II.3.4. STEEL CASING PIPE JOINTS**

Steel casing pipe joints shall be electric fusion (arc) welded by operators whose qualifications meet the requirements of the American Welding Society Standard procedures and in conformance with AWWA C206.

# *JEA Water and Wastewater Standards*

## *428 Gravity Sewers*

### **II.3.5. RESTRAINED JOINTS**

The restrainer shall be manufactured of ductile iron and shall meet or exceed all the requirements of ANSI A21.11 (AWWA C111) and ASTM A536. The restrainer system shall provide anchoring of PVC pipe to mechanical joint fittings or bell to spigot PVC pipe joints. Restraints shall provide a full 360-degree contact with sufficient gripping action to secure the clamp to the pipe and be designed so that restraint action is increased as a result of increases in line pressure. The restrainer shall accommodate the full working pressure rating of the pipe plus surge allowance.

### **II.3.6. FLANGE ADAPTERS**

Flange adapters shall be ductile iron manufactured to ASTM A536 standards. Bolt circles and bolt holes shall meet ANSI B16.1 for 125 pounds. Adapter flanges shall meet or exceed all test requirements of AWWA C900, ASTM D2241 and ASTM D1599.

### **II.3.7. PIPE COUPLINGS**

The contractor shall furnish and install pipe couplings as required to complete the work. Pipe couplings used to join two pieces of PVC pipe shall be sized to suit the outside diameter of the pipeline. Transition couplings shall be used to join pipes of different outside diameters. The D.I.P. coupling sleeve shall be manufactured of ductile iron conforming to ASTM A536 and be coated with 14 mils of epoxy. The bolts shall be manufactured of a metal of high corrosion resistance and shall conform to ANSI 21.11 (AWWA C111). Gaskets shall be wedge-type and manufactured of virgin SBR for water and wastewater service. The installation of all couplings shall be in accordance with manufacturer's recommendations. Unless approved otherwise by JEA, the maximum gap between pipe ends shall be: (based upon sleeve length) 5" sleeve, 1" gap; 7" sleeve, 2" gap; 10" sleeve, 3-1/2" gap; other per manufacturer's recommendation. After installation, all coupling surfaces including bolts and nuts shall be coated with an approved coating as specified in these specifications. PVC repair couplings shall be extra-long length, with gaskets and no internal stops. The PVC coupling shall be same SDR rating as the connecting pipe (SDR-26 at a minimum). Connection of gravity wastewater pipe of different materials shall be with a shear-resistant transition repair coupling. The coupling shall have a one piece molded PVC bushing gasket with an exterior 12 mil (min.) stainless steel shear ring. The coupling shall connect to the pipe ends with type 316 SS nut and bolt worm gear clamps. Coupling shall be ASTM C1173 & D5926 compliant, and be a Series 5000 Repair Coupling.

### **II.3.8. FULL CIRCLE REPAIR CLAMPS**

Full circle repair clamps shall have type 304 stainless steel shell, lugs, bolts, nuts and washers as per ASTM A193, A194, A240, or shall have type 304 stainless steel shell per ASTM A240, ductile iron lugs as per ASTM A536, and 304 stainless steel bolts, washers and nuts. Gaskets for both types shall be virgin SBR as per ASTM D2000 for water and wastewater service.

## **II.4. PIPING SUPPORTS**

The Contractor shall furnish and install all special pipe supports as shown on the drawings and as necessary to hold the piping and appurtenances in a firm, substantial manner at the lines and grades indicated on the drawings or as specified. Special pipe supports shall be worked out in the field and approved by the Engineer to suit local conditions and emergencies.

### **II.4.1. PIPE SADDLES**

Pipe saddles shall be shaped to fit the pipe with which they will be used and shall be capable of screw adjustment. Concrete piers shall conform accurately to the bottom one-third to one-half of

# *JEA Water and Wastewater Standards*

## *428 Gravity Sewers*

the pipe. Piping supports shall be placed so as to provide a uniform slope in the pipe without sagging. Supports shall be located wherever necessary, and in no case shall they exceed 8 feet on centers for stainless steel pipe and 4 feet on centers for PVC pipe.

### **II.4.2. CASING SPACERS**

Casing spacers shall be a two piece prefabricated unit by a single manufacturer. All casing spacers in a single casing pipe crossing shall be by the same manufacturer. Casing spacers shall have a shell made from either 304 stainless steel, 14-gauge mild steel which has been heat fusion coated with PVC plastic, (PVC coating shall be .01 inch thick over the entire band including the runner studs) or high density polyethylene. Casing spacers on 16-inch and smaller carrier pipe shall have 8-inch wide steel bands and casing spacers on 18-inch and larger carrier pipe shall have 12-inch wide steel bands, except high density polyethylene spacers shall have high density polyethylene bands. All casing spacers for 12-inch and smaller pipe size shall have four 10-gauge or 14-gauge steel risers with runners and casing spacers for 16-inch and larger pipe shall have six 10-gauge or 14-gauge steel risers with runners (two top and four bottom), except high density polyethylene spacers shall have one riser for every diameter inch of carrier pipe. The runners (risers) shall be either glass reinforced plastic, UHMW polymer or high density polyethylene. All nuts, bolts and washers shall be 304 stainless steel. All risers over 2 inches in height shall be reinforced. Wooden skids are not an acceptable alternate.

## **III. INSTALLATION**

### **III.1. REFERENCE POINTS AND LAYOUT**

The Contractor shall be responsible for setting all grade lines, centerline of construction, and locating property lines. JEA or the Owner will provide a bench mark. Any reference points, points of intersection, property corners, or bench marks, which are disturbed during construction, shall be restored by a Land Surveyor registered to practice in the State of Florida, and all costs thereof shall be borne by the Contractor. The Contractor shall assume all responsibility for the correctness of the grade and alignment stakes.

### **III.2. HANDLING AND CUTTING PIPE**

Every care shall be taken in handling and laying pipe and fittings to avoid damaging the pipe, scratching or marring machined surfaces, and abrasion of the pipe coating. The lined pipe and fittings must be handled only from the outside of the pipe and fittings. No forks, chains, straps, hooks, etc. shall be placed inside the pipe and fittings for lifting, positioning, or laying. If damaged, the material shall be repaired in accordance with the liner manufacturer's recommendations. Any fitting showing a crack and any fitting or pipe which has received a severe blow that may have caused an incipient fracture, even though no such fracture can be seen, shall be marked as rejected and removed at once from the work. In any pipe showing a distinct crack in which it is believed there is no incipient fracture beyond the limits of the visible crack, the cracked portion, if so approved by JEA, may be cut off before the pipe is laid so that the pipe used may be perfectly sound. The cut shall be made in the sound barrel at a point at least 12 inches from the visible limits of the crack. Except as otherwise approved, all cutting shall be done with a power driven cut off saw. All cut ends shall be examined for possible cracks caused by cutting.

### **III.3. PIPE INSTALLATION**

#### **III.3.1. GRAVITY WASTEWATER MAIN AND WATER MAIN SEPARATION REQUIREMENTS**

The minimum separation requirements between gravity wastewater and potable water mains shall be as outlined in specification Chapter VI. 2. - Section 350 and Detail Nos. S-26 and S-27. For gravity wastewater mains, the horizontal separation from existing, proposed and future structures

# *JEA Water and Wastewater Standards*

## *428 Gravity Sewers*

(including above ground structures, concrete footers and top of bank of ponds) shall be a minimum of 3 times the vertical depth of the deepest portion of the manhole to manhole wastewater run.

### **III.3.2. UTILITY LOCATES**

It shall be the Contractors responsibility to locate all underground utilities in advance of construction, to insure that no conflicts occur with the proposed line and grade. The contractor shall coordinate utility locates with Sunshine State One-Call of Florida, Inc. (#811 or web site [www.callsunshine.com](http://www.callsunshine.com)), at a minimum.

### **III.3.3. DEWATERING**

The trench must be dewatered when joints are made and kept dewatered with a dry trench bottom, until pipe trench has been backfilled. The pipe shall not be driven down to grade by striking it with any unyielding object. The Contractor shall take all necessary precautions to prevent flotation of the pipe due to flooding of the trench.

### **III.3.4. GRADE, DIRECTION AND ALIGNMENT**

The pipe laying shall proceed upgrade, beginning at the lower end of the wastewater, with all bell ends upgrade. In no case shall the pipe be walked on either before or after the joints have been made. Extreme care shall be taken to keep the pipe in exact alignment and elevation. Pipe shall be laid to conform accurately to the lines and grades indicated on the drawings. If approved by the Engineer, minor changes in the alignment but not the grade will be permitted to avoid underground facilities, provided that straight alignment can be maintained between manholes. However, if a conflict is found between an existing utility and proposed grade, the Contractor is to furnish the Engineer all pertinent information so that remedial design can be performed.

### **III.3.5. LAYING AND JOINTING**

The pipe shall be laid on an unyielding foundation with uniform bearing under the full length of the barrel of the pipe. Suitable excavations shall be made to receive the bell of each pipe, which shall be carefully laid true to line and grade. All adjustments to line and grade must be made by scraping away or filling in under the barrel of the pipe and not by wedging and blocking up any portion of the pipe. The spigot end of each pipe shall abut against the base of the socket of the adjacent pipe in such a manner that there will be no unevenness of any kind along the bottom halves of the pipes. Just before joining the pipes, the mating ends shall be thoroughly cleaned of all dirt, debris, and foreign material. The pipe shall be jointed in accordance with the recommendations of the manufacturer of the pipe and gasket.

### **III.3.6. PIPE COVER**

The cover over all piping shall be a minimum of 30 inches in unpaved areas and 36 inches in paved areas.

### **III.3.7. JOINTING PVC TO VITRIFIED CLAY PIPE**

Unless specifically indicated otherwise, connections of PVC to vitrified clay pipe in the run of the wastewater line shall be made with a JEA standards approved cast coupling.

### **III.3.8. BEDDING AND BACKFILL**

Immediately after the pipe has been jointed and inspected, sufficient backfill shall be performed to protect the pipe adequately from injury and movement. Unsuitable material shall be removed and replaced with AASHTO Class A-3 soil upon approval of the Engineer. A-3 soil and native material

# *JEA Water and Wastewater Standards*

## *428 Gravity Sewers*

backfilled shall be compacted to the requirements of Chapter II. 3. Section 408 of these specifications.

### **III.3.9. CLEANING**

All necessary precautions shall be taken to prevent the entrance of mud, sand or other obstructing material into the pipelines. As the work progresses, the interior of the wastewater shall be cleaned of all dirt, and foreign material. The Contractor shall flush all wastewater lines constructed with clean water, prior to final inspection, to assure complete removal of all debris and foreign material.

### **III.3.10. PLUGS**

Openings such as stubs, tees, or services along the lines shall be securely closed by means of an approved plug that fits into the bell of the pipe and is recommended by the pipe manufacturer. This plug shall be installed in such a manner that it may be removed at some future time without injury to the pipe itself. At the close of each day's work, and at other times when pipe is not being laid, the end of the pipe shall be temporarily closed with a plug.

### **III.3.11. CARRIER PIPES IN CASINGS**

All carrier pipes in casings shall utilize casing spacers installed on the carrier pipe, inside the casing pipe. Casing spacers shall be installed one foot on both sides of each carrier pipe joint, and at ten foot intervals along the carrier pipe for pipe up to 48 inches with 20 foot laying lengths. Casing spacers shall be installed one foot on both sides of each carrier pipe joint for pipe up to 48 inches with 13-foot laying lengths. For carrier pipes larger than 48 inches, casing placement shall be as recommended by the casing spacer manufacturer. A casing spacer shall also be installed within two feet of each of the ends of the casing pipe. All joints within steel casing pipe shall be restrained with mechanical restraining devices. End joints shall be tie rodded, with the ends of the rods welded to the end of the casing.

### **III.3.12. SYSTEM CONNECTIONS**

#### **III.3.12.1. JEA Supervision**

All connections and ties to JEA's Wastewater System will be performed by the Contractor under supervision of JEA.

#### **III.3.12.2. Lateral Connections**

Types of lateral connections shall be as shown on the drawings. Although the general location of lateral connections may be shown on the drawings, the actual location shall be determined by the Contractor, subject to approval by the Engineer. Each lateral connection shall be accurately recorded by stationing on the As-Built drawings which shall be furnished to the Engineer. Unless authorized by the Engineer in writing, or shown on the drawings, lateral connections shall be limited to 2 ties into new or existing dead end manholes. All lateral connections shall be terminated at the property line unless indicated otherwise on the drawings or directed otherwise by the Engineer. All active lateral connections on sanitary wastewater to be replaced shall be connected to the new sanitary wastewater. Contractor shall be responsible for locating lateral connections prior to construction. Unless approved otherwise by JEA, no gravity wastewater main with wastewater service laterals shall be constructed with a "depth of cut" greater than 12 feet (see Detail S-20).

#### **III.3.12.3. Marking Service Lines**

# *JEA Water and Wastewater Standards*

## *428 Gravity Sewers*

An "S" shall be cut in the curb (painted green) directly over each service line or in the street side of a sidewalk where no curb is available. In addition, for new development areas where the wastewater lateral is "not in use", a landscape timber (3" x 3" minimum P.T. timber, top painted green) w/marker ball at finish grade depth of 3' maximum shall be installed to mark the location of the 6-inch plug. For projects where no concrete curb exists, an electronic marker is required for all laterals, which are "NOT IN USE" at finish grade depth of 3' maximum. The electronic marker shall be a mid-range type as manufactured by Scotch Mark or JEA pre-approved equal. During the final inspection or project acceptance inspection, JEA may elect to field test the installed electronic markers utilizing JEA locate equipment. The contractor shall assist in the field locate services required to complete this test.

### **III.3.12.4. Wastewater Saddles**

A wastewater saddle may be utilized in the construction of a new wastewater service lateral which is tapping an existing (in-use) clay or PVC gravity wastewater main. A wastewater saddle shall not be used on totally new wastewater system work on HDPE gravity pipe mains. The saddle shall include a ductile iron saddle casting with corrosion-resistant paint, SBR gasket, 304 stainless steel band with 304 S.S. Adjusting bolts and 304 S.S. Pipe clamp.

### **III.3.13. STUB-OUTS**

Where shown on the drawings, stub-outs shall be provided for the connection of future wastewater lines to manholes. The end of each stub out shall be provided with a bell end which shall be closed by an approved plug as previously specified. Each stub-out shall be accurately referenced to the center of the manhole, and the actual invert elevation of each end of the stub out shall be accurately recorded on the As-Built drawings.

### **III.3.14. YARD PIPING**

Yard piping shall be defined as the wastewater service piping and appurtenances privately owned and located entirely on private property. All yard piping shall conform to local plumbing code and all applicable building codes. No work shall be done on private property without written consent of property owner (Temporary Construction Easement). Contractor must obtain plumbing permit prior to work.

### **III.3.15. LOCATE WIRE**

No locate wire is required on gravity lines.

## **III.4. FIELD TESTING**

All work constructed shall be subject to visual inspection for faulty alignment, defects, or leaks. Any such deviation or omission shall be corrected at once. All tests shall be made by the Contractor who shall provide necessary equipment for TV testing and lamping the system in the presence of, and under the supervision and instructions of JEA's representative. All costs for testing defined below shall be borne by the Contractor.

### **III.4.1. GENERAL REQUIREMENTS**

Pipe to be field tested shall be cleaned and free of any dirt, sand or debris, prior to CCTV inspection and in the presence of an authorized JEA representative. The wastewater line shall be introduced with enough water at the upstream manhole that it flows through the downstream manhole. The JEA representative shall verify the adequacy of the water flow and water depth. Inspections shall

# *JEA Water and Wastewater Standards*

## *428 Gravity Sewers*

commence within thirty (30) minutes of said verification. Underdrains if used shall be plugged and other ground water drainage (i.e. well point systems) shall be stopped to permit the ground water to return to normal levels insofar as practicable. If possible, service connections at the right-of-way shall not be made until after TV test have been successfully completed. The contractor shall provide at no additional cost to JEA a temporary plug and/or by-pass pumping on wastewater with active wastewater service laterals, if deemed necessary by the JEA representative to assure a quality TV inspection. If required by JEA, the contractor shall eliminate active flow in wastewater laterals by shutting off the water supply service to the contributing house(s). Contractor shall comply with the current JEA water outage procedures for shutting off customers' water service.

### III.4.2. REPORTS REQUIRED

A full report, as to the condition of pipe, type, depth, location of services at the main and termination point at the property line, length, type joint, and distance between manholes, etc., shall be furnished to JEA prior to the final acceptance of the main. Each manhole shall be identified on the DVD and report by manhole number and nearest address or intersection. In addition to the written report, a DVD disc (formatted for Windows Media Player or JEA approved equal) of the TV inspection of the main and each service conducted via lateral launch from the main shall be provided to JEA for review. The disc shall become the property of JEA.

### III.4.3. DEFECTS

Any pipe found to have defects, including but not limited to leaks, cracks, pipe deflection from external pressures, rolled or pinched gaskets, joint gaps (wider than 1 inch), or holding water greater than the following limits (a "dip") or otherwise defective shall be removed and replaced with new pipe at no additional cost to JEA.

#### III.4.3.1. Dips

A "dip" is defined as any water holding depth which is equal or greater than the "minimum" depth as listed below. There shall not be any more than 1 "dip" per 135 linear feet of wastewater pipe installed (1 minimum). The defective pipe sections, or those "dip" sections over the allowable limit, shall be removed and replaced (at no cost to JEA). Each run of pipe, between two manholes, shall be evaluated independently for compliance. Any "dip" which is greater than the "maximum" "dip" depths listed below are not acceptable and shall be removed and replaced at no cost to JEA. Regardless of the number of "dips" in the line section, if, in the opinion of the JEA inspector, the number and/or location of the "dips" is believed to create an unacceptable operating condition, than the defective pipe section(s) shall be removed and replaced at no cost to JEA. Any deviation from these "dip" limitations must be approved by a JEA Manager.

Pipe Size	Water Holding Depth (inches)	
	Minimum	Maximum
8 inch - 10 inch	0.50	1.00
12 inch - 15 inch	0.75	1.50
18 inch - 21 inch	1.00	2.00
24 inch and greater	1.25	2.50

#### III.4.3.2. Deformation/Deflection Limits

Pipe shall be tested with a mandrel for deformation or deflection. Any pipe found to be deformed and/or deflected in excess of 7.5% of the nominal diameter of the pipe shall



# *JEA Water and Wastewater Standards*

## *428 Gravity Sewers*

be removed and replaced with new pipe at no additional cost to JEA. All mandrels used in testing shall be available to be checked for proper sizing by use of truing rings at the request of a JEA Representative. Results of the test shall be submitted to JEA for review and approval. The use of a re-rounding device or other similar equipment is not permitted to correct deflected (egg shape) pipe.

### **III.4.4. LAMP TESTING**

Lamp tests shall be observed first hand by JEA's representative to assure proper horizontal alignment. Upon completion, each section of wastewater line shall show a full circle of light when lamped between manholes.

### **III.4.5. TELEVISION INSPECTION**

#### **III.4.5.1. Scope**

Television inspection will be required on all new and/or replacement wastewater gravity sewer pipe constructed. The Contractor shall provide this service. JEA will instruct the Contractor when this requirement shall be performed. The newly constructed wastewater sewer pipe shall be televised in the presence of JEA's representative. Unless approved otherwise by JEA, prior to CCTV inspections, all manhole inverts must be built and roadways shall be lime rocked and have density test completed. Gravity in easements must be compacted backfill to final grade. For areas which require "Special Pavement" all base material shall be compacted ready for asphalt pavement prior to TV work.

#### **III.4.5.2. Quality Assurance**

Inspection Operation shall be conducted by experienced personnel trained in locating and identifying structural defects in pipe, leaks, obstruction, faulty alignment or any abnormalities detrimental to the proper functioning of the wastewater system. Contractor shall have a minimum of (4) years of experience with internal examination of wastewater lines using CCTV equipment. Unless approved otherwise by JEA, a JEA employee, experienced in CCTV inspections shall be present during all inspection operations. JEA reserves the right to reject any tests due to quality or tests performed without the knowledge or presence of a JEA representative.

#### **III.4.5.3. Video Inspection Equipment**

The CCTV inspection camera shall be specifically designed and constructed for wastewater line inspections, and shall be a self-contained audio-visual system complete with winches, (power or mechanical) or be self-propelled, with a minimum of 500 feet of cable, monitor, video tape recorder, and suitable measuring devices accurate to + 1.0% of the total length (e.g. accurate within 5.0 feet for 500 feet total length) and all necessary equipment for the successful completion of the video inspection. The video inspection system shall have the ability to superimpose the measured footage onto the monitor screen and be recorded visually by the video tape recorder. The camera shall be operative in 100 percent humidity conditions and shall be capable of producing a full-color picture at a remote monitor. Lighting and camera quality shall be suitable to allow a clear, in-focus picture of a minimum of 6 linear feet of the entire inside periphery of the wastewater pipe. The camera shall have a minimum resolution of 320 lines to ensure peak picture quality throughout all conditions encountered during the investigation, a variable intensity control of the lights and

# *JEA Water and Wastewater Standards*

## *428 Gravity Sewers*

remote control adjustments for focus and iris shall be located at the monitoring station. The camera shall be equipped with a rotating head enabling a view of 90 degrees to the axis to be inspected so that service connections can be properly inspected.

### III.4.5.4. Color Video Monitors

Color video monitor shall be located within a temperature controlled studio that will allow seating for two authorized viewing personnel, (Contractor representative and JEA field representative) in addition to the operating technician. All persons shall have a clear and comfortable view of the monitor. Monitor shall have a resolution capability of no less than 650 lines. Continuously displayed on the monitor as recorded by the video camera shall be the date of the survey, number designation of the manhole to manhole pipe segment being surveyed, and a continuous forward and reverse read out of camera distance from the reference manhole. Audio descriptions of the operating technician's observations shall be recorded on the video tape. Picture quality and definition shall be to the satisfaction of the JEA. If the picture quality is unsatisfactory, the video equipment shall be replaced.

### III.4.6. MANHOLE INSPECTIONS

#### III.4.6.1. General Requirements

All manholes shall be inspected for leaks and any defects that may cause infiltration, or weaken the structural integrity. Before the final inspection, manholes shall be trimmed of any excess joint sealant. Any voids in pre-cast manhole shall be filled with non-shrink grout and the grouted areas shall be thoroughly field coated (2 coats) with bituminous waterproofing excluding invert and bench, as required. The gasket on the manhole cover shall be inspected for cuts, tears, scraps and proper fit. If found damaged, the entire gasket seal shall be replaced in accordance with the manufacturer's recommendation, at contractors expense.

#### III.4.6.2. Television Inspection

Contractor shall be required to televise the interior of each new and/or replacement manhole utilizing a pole mounted type camera. Televising of the manhole structures to occur when gravity wastewater mains are CCTV'd, and in the presence of JEA representative. Results shall be observed by the JEA representative on the CCTV color monitor used for viewing the associated wastewater main. Interior manhole structure to be televised shall be free of debris prior to inspection. Manhole to be televised shall require review of frame, cone, risers, joints, bench, flow channel, and each pipe connection.

#### III.4.6.3. Manhole Inspection Report

Each manhole shall be identified on the DVD and report (both to be copied and delivered to JEA for review and its files) by manhole number and nearest address/intersection or by as-built station number/offset.

#### III.4.6.4. Lateral Inspection

All laterals shall be inspected to insure proper connection to the gravity main.

## IV. GRAVITY SEWER ABANDONMENT

# *JEA Water and Wastewater Standards*

## *428 Gravity Sewers*

Abandonment of all existing gravity wastewater lines falling within the limits of street, alley or highway right-of-ways shall be treated in the following manner. Existing gravity wastewater lines will not be classified as abandoned until such time as all existing lateral connections have been transferred to a new operating wastewater line.

### **IV.1. SEALED**

All abandoned wastewater lines where called for on the Contract Drawings to be sealed, shall be sealed at each end and at every break in the line. Seals for all pipe sizes shall be of Class "C" concrete or concrete grout and rubble and shall extend into the wastewater for at least 12 inches.

### **IV.2. GROUT FILLED**

All abandoned wastewater lines where called for on the Contract Drawings to be grout filled shall be accomplished by the following procedure. Lines to be grout filled shall be completely filled with a sand-cement grout by pumping the mixture into the pipelines from downstream or low end of the line with an approved grout pump. The Contractor shall clean the line of all sand and debris prior to grout filling. Grout for filling abandoned wastewater lines shall consist of at least 15 percent Portland cement by volume and shall be mixed to a consistency suitable for pumping. Sand used in the grout mixture shall meet the requirements for fine aggregate as specified in the City Standard Specifications for the City of Jacksonville, Public Works Department, Section 130.

### **IV.3. REMOVAL OF EXISTING PIPE**

Where shown on the drawings or called for elsewhere in the Contract Documents to remove existing, shall mean the complete removal and disposal of the wastewater pipe as specified by the Engineer. Excavation and backfill shall be as specified in Chapter II. 3. - Section 408 of these specifications.

### **IV.4. SEAL AT EXISTING STRUCTURES**

When wastewater lines that are to be abandoned or existing lines to be removed fall above or below the new line to be constructed, the opening left in the existing manhole wall shall be thoroughly plugged with non-shrinking mortar, applied and cured in strict conformance with the manufacturer's recommendations. The mortar shall be finished smooth and flush with the adjoining interior manhole wall surface. Any existing liner material shall be repaired.

## **V. PERMITTED CROSSINGS**

### **V.1. STATE HIGHWAY CROSSINGS**

Permits for all work within the right-of-way of a state highway will be obtained by the Engineer. The Contractor shall, however, verify the existence of the permit before commencing work in this area. All work related to the state highway crossings shall be in full compliance with the terms of the permit and in accordance with the Utility Accommodation Guide and standard specifications, of the Florida State Department of Transportation. Unless otherwise shown on the drawings and approved permit.

### **V.2. RAILROAD CROSSINGS**

Permits for all work within the right-of-way of a railroad will be obtained by the Engineer. The Contractor shall, however, verify existence of a permit before commencing work in this area. All work related to the railroad crossings shall be in full compliance with the terms of the permit and AREA Specifications for Pipeline Crossings under Railway Tracks for Non-Flammable Substances. The carrier pipe shall be placed in steel casing pipe under the railroad crossing by jacking and boring. The wastewater main shall then be placed in the casing with approved casing spacers as specified in this section. All joints within carrier pipe shall be mechanically restrained joints. After inspection by the Engineer, the ends of the casing shall be

*JEA Water and Wastewater Standards*  
*428 Gravity Sewers*

sealed with 2,500 psi. concrete, not less than 12 inches thick. Upon completion and prior to final acceptance, the Contractor shall place crossing markers of a type acceptable to the Railroad Company at each end of the crossing at the railroad right-of-way.

*Blank Page*

## **429 - WASTEWATER FORCE MAINS**

### **I. GENERAL REQUIREMENTS**

#### **I.1. SCOPE OF WORK**

The Contractor shall furnish and install a wastewater force main system, complete, tested and ready for operation. The work shall also include such connections, reconnections, temporary service and all other provisions in regard to the existing operation and modification as is required to perform the new work. All references to Industry Standards (ASTM, ANSI, AWWA, etc.) shall be to the latest revision unless otherwise stated. Only those materials included in the JEA Water and Wastewater Standards Manual shall be installed. All materials shall be new unless specifically called for otherwise. For the supply of domestic water during construction, the contractor shall utilize a JEA meter assembly (meter & back flow device). In most cases, domestic water will be supplied from a jumper line between the potable watermain, through a JEA meter assembly to the new wastewater force main. Un-accountable water quantities shall be minimized where possible. For projects where pipelines are twenty four (24) inch and larger, contractor experience in the installation of large diameter (24-inches and larger) pipe is required. The experience shall be with the type of pipe being installed.

#### **I.2. PROJECT SCHEDULE AND COOPERATION**

The project schedule shall be established on the basis of working a normal work schedule including five days per week, single shift, eight hours per day or four days per week, single shift, ten hours per day. Unless approved otherwise by JEA, normal or general items of work, such as leakage and pressure testing, density testing and final inspections, shall be scheduled during the normal work schedule. Due to operational and manpower limitations on the JEA systems, JEA may require the contractor to perform work outside of the normal workschedule. These operational and manpower limitations, include but not limited to, line filling and flushing operation, tie-in work (cut-in work or other work) and other phases of the work which may impact the continued (non-interruptible) service to existing JEA customers. The contractor shall plan and anticipate the cost impact of these system limitations and provide such work or services at no additional cost to JEA.

#### **I.3. SHOP DRAWING SUBMITTALS**

Actual catalog data, brochures and descriptive literature will not be required for items of standard usage which meet the requirements of Chapter X and Chapter XI of the JEA Water and Wastewater Standards Manual. Any specialty item not shown in this manual will require a complete shop drawing submittal. The Engineer may at any time require the Contractor to provide a complete detailed shop drawing submittal for any material which may, in the Engineer's opinion, not be in compliance with the JEA Water and Wastewater Standards.

##### **I.3.1. PIPE 20 INCHES AND LARGER**

###### **I.3.1.1. Material Submittals Required**

Submit shop drawings per the specifications for the materials (restrained joints, PVC pipe and construction equipment) proposed for installation of pipelines 20 inch and larger. PVC Pipe: Industry reference standards, product description and data sheets, gaskets, spigot insertion mark dimension, installation instructions, and other items to allow a complete review by the Engineer.

###### **I.3.1.2. Construction Equipment Submittals Required**

# *JEA Water and Wastewater Standards*

## *429 Wastewater Force Mains*

Equipment proposed for the installation of the pipeline: machinery and calibrated torque wrenches/gauges.

### **I.4. AS-BUILT DRAWING**

As-built drawings (to be utilized in future utility locate work) are required on all water, wastewater, force main, pump station and reclaimed water projects, including projects for JEA, City of Jacksonville, JTA, DOT, private developments (utilities to be dedicated to JEA), and other City Authorities, etc. As-built drawings shall be in accordance with specification Chapter VI. - Section 501, entitled "As-built Drawings". As built drawings shall be reviewed and approved by JEA. The cost to provide as- built drawings shall be included as part of the related work requirements or general conditions for the utility work.

### **I.5. WARRANTY**

The Contractor shall provide to JEA a two (2) year unconditional warranty after substantial project completion or acceptance or any designated portion thereof. The warranty shall include materials and installation and shall constitute complete replacement and delivery to the site of materials and installation of same to replace defective materials or defective workmanship with new materials/workmanship conforming to the specifications.

### **I.6. FIELD DATA SHEETS**

Provide field data sheets that contain the following information for recording data during installation of the pipe (every joint), fittings, valves, specials, and restraining devices: Spigot reference mark dimension, distance between restrainer rings on each side of pipe joint, and torque values for bolts and threaded rods.

### **I.7. LOCATE WIRE REPORT**

Contractor shall submit for approval a final Locate Wire Report as described in this section prior to substantial completion.

## **II. MATERIALS**

All material shall be free from defects impairing strength and durability, shall be of the best commercial quality for the purpose specified, and shall have structural properties sufficient to safely sustain or withstand strains and stresses to which it is normally subjected and be true to detail.

### **II.1. PIPE**

Pipe for force main lines in sizes up to and including 48 inches shall be polyvinyl chloride (PVC), fiberglass or high density polyethylene (HDPE), as shown on the drawings and as herein specified. Pipe for force main lines larger than 48 inches shall be fiberglass as shown on the drawings and herein specified. Pipe to be used as a casing in sizes 4 inches and larger shall be welded steel pipe as shown on the drawings and as herein specified. Pipe to be installed underground shall be push- on joint, fused or mechanical joint type. Pipe installed on bridges, piles or other above ground installations shall be Stainless Steel. PVC pipe shall not be used in above ground applications unless encased. Underground pipe shall be furnished in nominal 18 or 20 foot laying lengths unless indicated otherwise on the drawings. Pipe shall be cut to length as required to fit installation conditions. PVC or HDPE piping shall not be utilized on bridges or other above ground applications unless incased. Pipe sizes and applications shall conform to the following chart.

PIPE	PIPE SIZE*	JOINT TYPE	APPLICATION
PVC (Sch. 40)	3 inches and smaller	Solvent Weld	Below ground
PVC (Sch. 80)	3 inches and smaller	Solvent Weld	Below ground

# JEA Water and Wastewater Standards

## 429 Wastewater Force Mains

PVC DR18	4 inches and larger	Push-on joint	Below ground
Polyethylene (HDPE)	4 inches and larger	Fused	Directional drill, Pipe bursting or approved JEA (Below ground)
Stainless Steel	4 inches and larger	Welded, flanged	Above or below ground
Steel	4 inches and larger	Welded	Casing only
PVC DR18	4 to 12 inches	Fusible PVC	Below ground
PVC DR 25	16 inches and larger	Push-on joint	Below ground
Fiberglass Reinforced Polymer Mortar Pipe	24 inches and larger	Bell-spigot joint	Above or below ground

\*Pipe sizes 14" and 18" shall not be utilized unless specifically approved by JEA (excluding HDPE).

### II.1.1. POLYVINYL CHLORIDE PRESSURE PIPE

Pipe shall be virgin polyvinyl chloride (PVC) pipe for force main and shall have a bell type coupling with a thickened wall section integral with the pipe barrel in accordance with ASTM D3139. Elastomeric seals shall meet ASTM F477 and shall be attached to the bell utilizing glue (AWWA and manufacturer's approved type). The pipe material shall be clean, virgin, National Sanitation Foundation No. 14 approved, Class 12454-A or 12454-B PVC compound conforming to ASTM resin specification D1784. Each length shall be clearly marked with the name of the manufacturer, location of the plant, pressure rating, nominal pipe diameter and length. Storage and handling of PVC pipe shall be in accordance with chapter 6 of AWWA Manual M23. All PVC DR 18 and DR 25 pipe shall be green.

#### II.1.1.1. PVC 1120, Class 100, DR 25 Pipe

Pipe shall conform to AWWA Standard C905 for 14 inch through 36 inch pipe. Pipe is to be manufactured to ductile iron pipe equivalent outside diameters.

#### II.1.1.2. PVC 1120, Class 150, DR 18 Pipe

Pipe shall conform to AWWA Standard C900 for 4 inch through 12 inch pipe, and AWWA Standard C905 for 14 inch through 36 inch pipe. Pipe is to be manufactured to ductile iron pipe equivalent outside diameters.

#### II.1.1.3. PVC 1120, Schedule 40 and Schedule 80 Pipe

Pipe shall conform to ASTM D1784 and D1785. Green color pipe. Pipe is to be manufactured to I.P.S. (Steel) Standard Pipe equivalent outside diameters. Pipe shall be marked NSF-PW approved. To insure a water-tight connection, the contractor shall utilize "purple primer" and "rain or shine glue" or JEA approved equal.

### II.1.2. FIBERGLASS REINFORCED POLYMER MORTAR PIPE

#### II.1.2.1. Materials

##### II.1.2.1.1. Resin Systems



# *JEA Water and Wastewater Standards*

## *429 Wastewater Force Mains*

The manufacturer shall use only polyester resin systems with a proven history of performance in this particular application. The historical data shall have been acquired from a composite material of similar construction and composition as the proposed product.

### II.1.2.1.2. Glass Reinforcements

The reinforcing glass fibers used to manufacture the components shall be of highest quality commercial grade E-glass filaments with binder and sizing compatible with impregnating resins.

### II.1.2.1.3. Silica Sand

Sand shall be minimum 98% silica with a maximum moisture content of 0.2%.

### II.1.2.1.4. Additives

Resin additives, such as curing agents, pigments, dyes, fillers, thixotropic agents, etc., when used shall not detrimentally affect the performance of the product.

### II.1.2.1.5. Elastomeric Gaskets

Gaskets shall be supplied by qualified gasket manufacturers and be suitable for the service intended.

## II.1.2.2. Manufacture And Construction

### II.1.2.2.1. Pipes

Manufacture (CCFRPM) pipe by the centrifugal casting process to result in a dense nonporous, corrosion-resistant, consistent composite structure. The pipe nominal pressure class (PN) shall be equal to or greater than the maximum sustained operating pressure of the line (PN 150 minimum). The maximum transient (operating plus surge) pressure of the line shall not exceed the pipe nominal pressure class by more than 40%. No exterior pipe color required.

### II.1.2.2.2. Joints

Unless otherwise specified, the pipe shall be field connected with fiberglass sleeve couplings that utilize elastomeric sealing gaskets made of EPDM rubber compound as the sole means to maintain joint water tightness. The joints must meet the performance requirements of ASTM D4161. Tie-ins, when needed, may utilize gasket-sealed mechanical couplings. Restrained joints may be provided by reinforced fiberglass materials as per the pipe manufacturer's recommendation and as approved by JEA. Other restraint devices must be approved by JEA (follow the D.I.P. Restraint Joint Schedule, at a minimum).

### II.1.2.2.3. Fittings

Flanges, elbows, reducers, tee, wyes, laterals and other fittings shall be capable of withstanding all operating conditions when installed. They may

# *JEA Water and Wastewater Standards*

## *429 Wastewater Force Mains*

be contact molded or manufactured from mitered sections of pipe joined by glass- fiber-reinforced overlays. If approved by JEA, properly protected standard ductile iron fittings may also be used. Unbalanced thrust forces shall be restrained with thrust blocks, axial restraint systems or other suitable methods as approved by JEA. Fiberglass tees, wyes, laterals, or other similar fittings shall be fully encased in reinforced concrete designed to withstand the pressure forces. The pipe manufacturer shall be consulted during the design of the restraint system.

### II.1.2.3. Dimensions

#### II.1.2.3.1. Diameters

The actual outside diameter (18" to 48") of the pipes shall be in accordance with AWWA C950. For other diameters, OD's shall be per manufacturer's literature.

#### II.1.2.3.2. Lengths

Pipe shall be supplied in nominal lengths of 20 feet. Actual laying length shall be nominal +1, -4 inches. At least 90% of the total footage of each size and class of pipe, excluding special order lengths, shall be furnished in nominal length sections.

#### II.1.2.3.3. Wall Thickness

The minimum wall thickness shall be the stated design thickness. For pipe sizes 27 inch thru 36 inch utilize PN 150 minimum. For pipe sizes larger than 36 inch utilize PN 100 minimum.

### II.1.2.4. Testing

#### II.1.2.4.1. Pipes

Pipes shall be manufactured in accordance with the applicable standard.

#### II.1.2.4.2. Joints

Coupling joints shall meet the requirements of ASTM D4161.

#### II.1.2.4.3. Stiffness

Minimum pipe stiffness when tested in accordance with ASTM D2412 shall normally be 36 psi.

#### II.1.2.4.4. Tensile Strength

Pipe hoop tensile strength for pressure pipe shall be verified as specified in applicable standard (ASTM D3754 or AWWA C950) or by random burst testing at the same sampling frequency. All pipes shall be capable of withstanding a test pressure of two (2) times the maximum sustained operating pressure of the line without leaking or cracking. This performance shall be verified as agreed between the buyer and seller.

### II.1.3. STEEL CASING PIPE

---

# JEA Water and Wastewater Standards

## 429 Wastewater Force Mains

Pipe to be used as a casing shall conform to either ASTM Standard A139 for "Electric Fusion (arc) Welded Steel Pipe" with minimum yield strength of 35,000 psi or "API Specification API-5LX, Grade X-42 Welded Steel Pipe". Wall thickness shall meet the requirements of the latest Revision of the American Railway Engineering Association Manual of Recommended Practice or the Florida Department of Transportation Standard Specification for Road and Bridge Construction, as applicable. For street uses which are not DOT or railroad, use DOT casing thickness unless otherwise indicated by Engineer. All pipe furnished by the manufacturer shall be cast and machined at one foundry location to assure quality control and provide satisfactory test data. Full pipe length shall be provided. No short pipe lengths less than 8-feet long will be allowed unless approved by JEA. The pipe ends shall be tapered where welding is required.

### II.1.4. HIGH DENSITY POLYETHYLENE (HDPE) PIPE

It should be noted that the use of this product (especially for DR-11 pipe) may require up-sizing the main so that the inside diameter is approximately the same as PVC size where applicable. See Horizontal Directional Drilling (Chapter VI. 2. - Section 750 and 755) for technical specifications for this product and associated construction standards.

### II.1.5. STAINLESS STEEL PIPE AND FITTING SYSTEM

Pipe shall be manufactured from ASTM-A240 annealed and pickled sheets and plates in accordance with ASTM A778 in grade 316L stainless steel. Pipe shall be manufactured to nominal pipe sizes as listed in ANSI B36.19, Table 2. The pipe wall thickness shall be schedule 40 for all pipe sizes. Piping system shall be capable of withstanding satisfactorily all resultant forces exerted by normal pressure conditions, thermal expansion & contraction, and any surge pressures which may arrive from flow reversals during start up or shut down of the system. Fittings may be 316 stainless steel flanged type manufactured in accordance with ASTM-A774, AWWA C110 of the same raw material and in the same thicknesses as the pipe. Fittings may also be flanged ductile iron with specialty inside coating. The fittings utilized at wastewater pump station sites shall only be flanged stainless steel (no butt weld fittings) or flanged ductile iron with specialty inside coating. The finish on the raw material, manufactured to ASTM A-240 will be No. 1, HRAP (hot rolled annealed and pickled) or better. The finish on the completed pipe and fittings shall be as specified in ASTM A778 and A774, respectively. Transition from PVC to stainless steel flange to mechanical joint.

### II.1.6. FUSIBLE PVC PIPE (4"-12" SIZE)

May be used on potable water or reclaimed water systems. Fusible PVC may be utilized for directional drilling and direct bury applications. Pipe shall meet C-900 pressure class, DR-18 wall thickness and color coded. The pipe shall be marked with the name and location of the manufacturer, pressure rating and size. Unless approved otherwise by JEA, the bending radius shall not exceed 50% of the manufacturer's recommendation and the pulling force shall not exceed 80% of the manufacturer's recommendation.

## II.2. FITTINGS

Fittings 4 inches and larger on push-on joint pipe installed underground shall be PVC with restrained push-on bell type joint with pressure rating to match the pipe, at a minimum. Fittings 4 inches and larger installed above ground shall be ductile iron with flanged ends or restrained joints unless shown otherwise on the drawings. Large tee fittings (16 inches and larger) shall be ductile iron only.

FITTING SIZE	PIPE	FITTING*	JOINT TYPE	APPLICATION
--------------	------	----------	------------	-------------

# JEA Water and Wastewater Standards

## 429 Wastewater Force Mains

3 inches and smaller	PVC	Stainless Steel	Solvent Weld x Thread	Buried
3 inches and smaller	PVC	PVC	Solvent Weld	Buried
4 inches to 12 inches	PVC	PVC	Restrained Push-on joint	Buried
4 inches to 12 inches	PVC or Ductile Iron	Ductile Iron	Restrained Push-on joint or Flanged	Above ground
4 inches and larger	Stainless Steel	Stainless Steel	Welded or flanged	Above or below ground
<i>4 inches and larger</i>	<i>Polyethylene (HDPE)</i>	<i>Polyethylene (HDPE)</i>	<i>Fused</i>	<i>Directional drill, Pipe bursting or approved JEA (Buried)</i>
16 inches and larger	PVC	Ductile Iron	Restrained Push-on joint	Buried
16 inches and larger	PVC	Ductile Iron	Flanged	Above ground
<i>24 inches and larger</i>	<i>Fiberglass Reinforced Polymer Mortar Pipe</i>	<i>Fiberglass Reinforced Polymer Mortar Pipe</i>	<i>Bell-spigot joint</i>	<i>Above or below ground</i>

### II.2.1. DUCTILE IRON FITTINGS

Ductile iron fittings shall have a minimum working pressure of 250 psi. Fittings shall conform to ANSI Specification A21.10 (AWWA C110), A21.11 (AWWA C111), A21.15 (AWWA C115) and/or A21.53 (AWWA C153). Fittings shall also be certified by ISO 9000 by an accredited registrar. Compact fittings shall normally be installed. Long body fittings shall be used where the drawings specifically call for long body fittings, where compact fittings are not available, or at the option of the Contractor when the laying length is not controlled by compact fitting patterns. All fittings shall be UL/FM approved and shall conform to NSF Standard 61 as applicable. All fittings furnished by the approved manufacturer shall be cast and machined at one foundry location to assure quality control and provide satisfactory test data. Fittings shall have cast on them the pressure rating, nominal diameter of openings, manufacturer's name, foundry location, plant code and degrees or fraction of the circle. Cast letters and figures shall be on the outside body of the fitting. The JEA may require random ductile testing of manufacturer's fittings. All ductile iron fittings shall be externally coated and internally lined as specified in this section. Ductile iron welded-on outlets are not acceptable. In lieu of ductile tee/fittings, a tapping sleeve may be utilized on 24 inch and larger (D.I.P or PVC) pipe for outlets 12 inches and smaller.

### II.2.2. PVC (POLYVINYL CHLORIDE) FITTINGS

Fittings that are 3-inch and smaller may be PVC with push-on bell type joint or PVC with solvent weld joints as outlined above. Fittings that are 4 inches and larger shall be restrained push on bell joint. Restraints shall be in accordance with this specification regarding installation and material. The fittings shall conform to the appropriate sections of these specifications for PVC pipe and PVC pipe joints.

#### II.2.2.1. PVC 1120, Class 150, DR 18 Fittings

# ***JEA Water and Wastewater Standards***

## ***429 Wastewater Force Mains***

PVC fittings 4-inch through 12-inch may be used with PVC C900 pipe. Fittings shall be PVC injection molded, made from materials meeting or exceeding the requirements of cell class 12454-B material as defined in ASTM D1784. All PVC fittings must comply with, or exceed, AWWA C907. All fittings must be designed to the pressure class of DR18, with a pressure rating of 150 psi and a 2.5 to 1 factor of safety. Virgin materials only shall be used in the manufacture of PVC pressure fittings. These fittings must have UL-FM approval and shall comply with or exceed all ASTM Standards for PVC fittings. All fittings must have NSF-61 approval. The elastomeric gasket shall comply with the requirements specified in ASTM F477 and shall be attached to the bell utilizing glue (AWWA and manufacturer's approved type).

### **II.2.2.2. PVC Fabricated Fittings (14" And Larger)**

Fittings (except TEE fittings) shall be fabricated from PVC pipe meeting the requirements of AWWA C-905. The component pipe segments and bonds between fittings shall be free from voids, cracks, inclusions and other defects. The joining surfaces of the spigots and bells shall be free from imperfections that could cause leaks. When component segments are joined using solvent cement, the procedure shall conform to the standard practice for making pressure joints outlined in ASTM D2855. Reinforcement may be applied and permanently bonded to the outside surfaces of the fitting. Reinforcement overwrap shall be in compliance with the appropriate sections of AWWA C-905. Tee fittings must be ductile iron. The elastomeric gasket shall comply with the requirements as specified in ASTM-F472 and shall be attached to the bell utilizing glue (AWWA and manufacturer's approved type). Fittings shall be tested in accordance with the appropriate sections of AWWA C-905. All fittings shall include the following markings: nominal size, PVC pressure rating, pressure class and manufacturer name and/or trademark. Fittings color shall be green or white.

### **II.2.2.3. PVC 1120, Schedule 40 and Schedule 80 Fittings**

Schedule 40 and Schedule 80 fittings shall have solvent weld joints and shall be in accordance with ASTM D2672 and white, grey or green color.

### **II.2.3. HDPE FITTINGS**

See "Horizontal Directional Drilling", (Chapter VI. 2. - Section 750 and 755), for technical specifications for this product and associated construction standards.

### **II.2.4. NON-STANDARD FITTINGS AND WALL CASTINGS**

Fittings having nonstandard dimensions and cast specifically for this project shall be of approved design. They shall be manufactured to meet the requirements of the same specifications and shall have the same diameter and thickness as standard fittings, but their laying lengths and types of ends shall be determined by their positions in the pipelines and by the particular piping to which they connect. Wall castings shall be of the size and types indicated on the drawings. Flanges, facing, and drilling shall conform to the 125-pound American National Standard. Flanges shall be drilled and tapped for studs. Other dimensions shall be substantially equal to corresponding parts of standard bell and spigot fittings.

### **II.2.5. STAINLESS STEEL FITTINGS**

Fittings may be 316 stainless steel butt weld or flanged type manufactured in accordance with ASTM-A-774 of the same raw material and in the same thicknesses as the pipe. Fittings may also be flanged ductile iron with specialty inside coating. The fittings utilized at wastewater pump station

# *JEA Water and Wastewater Standards*

## *429 Wastewater Force Mains*

sites shall only be flanged stainless steel (no butt weld fittings) or flanged ductile iron with specialty inside coating.

### **II.3. JOINTS**

Type of joint used shall meet the following specifications or be approved by the Engineer prior to installation. Joints shall be made in accordance with approved printed instructions of the manufacturer, and shall be absolutely watertight.

#### **II.3.1. MECHANICAL JOINTS**

All jointing materials for mechanical joints shall be provided by the pipe and/or fitting manufacturer. Material assembly and bolting shall be in accordance with ANSI Specification A21.11 (AWWA C111). All glands shall be made of ductile iron only.

#### **II.3.2. PVC PUSH-ON JOINTS**

PVC pipe joints shall be the manufacturer's standard push-on bell type with rubber sealing ring in accordance with ASTM D3139. Elastomeric gaskets shall conform to ASTM F477.

#### **II.3.3. BALL AND SOCKET JOINTS**

Where subaqueous joints are indicated, joints shall be bolted or boltless flexible ball and socket joints conforming to the pressure and thickness requirements of ANSI A21.10 (AWWA C110) and ANSI A21.51 (AWWA C151) and shall be capable of providing a maximum deflection of fifteen degrees at each joint. Joints and gasket material shall be manufacturer's standard. The specific type joint shall be as shown on the drawings and/or as approved by the Engineer. Installation shall be in accordance with the manufacturer's recommended practice.

#### **II.3.4. FLANGED JOINTS**

##### **II.3.4.1. Stainless Steel Flanges**

Flanged pipe and fitting ends shall be made up of type 316L stainless steel welded on flanges drilled to ANSI 16.1 class 125 standard. The flange shall be continuously welded on both sides to the pipe or fitting. Bolts and other hardware shall be 316L stainless steel. Gaskets shall be 1/8" full face SBR Rubber.

##### **II.3.4.2. Flanged Couple Adapter**

A restrained ductile iron flanged coupling adapter (flanged X MJ) with special interior coating may be utilized to transition between different pipe materials (PVC to S/S). Flanged adapters shall only be utilized if no other method is possible. Flange adapters shall be ductile iron manufactured to ASTM A536 standards. Bolt circles and bolt holes shall meet ANSI B16.1 for 125 pounds. Adapter flanges shall meet or exceed all test requirements of AWWA C900, ASTM D2241 and ASTM D1599.

#### **II.3.5. THREADED CONNECTIONS**

Threaded pipe (2" size and smaller), gauge or instrument connections shall be 316 stainless steel 150-pound threaded conforming to ASTM A-182 or ASTM A-276.

#### **II.3.6. MACHINED SURFACES**

Machined surfaces shall be cleaned and coated with a suitable rust preventive coating at the shop immediately after being machined.

# *JEA Water and Wastewater Standards*

## *429 Wastewater Force Mains*

### **II.3.7. STEEL CASING PIPE JOINTS**

Steel casing pipe joints shall be electric fusion (arc) welded by operators whose qualifications meet the requirements of the American Welding Society Standard procedures and in conformance with AWWA C206. For field welds, the joints to be welded shall be tapered (approximately 45 degree taper).

### **II.3.8. POLYVINYL CHLORIDE SOLVENT WELD JOINTS**

Pipe joints for schedule 40 or schedule 80 pipe shall be solvent weld joints. The solvent cement shall comply with ASTM D2564. The joint shall be made in accordance with ASTM D2855. The joint shall conform to ASTM D2672.

### **II.3.9. RESTRAINED JOINTS**

The restrainer shall be manufactured of ductile iron and shall meet or exceed all the requirements of ANSI A21.11 (AWWA C111) and ASTM A536. The restrainer system shall provide anchoring ductile iron pipe and fittings, valves and PVC pipe to mechanical joint pipe or fittings, or bell to spigot PVC pipe joints. The restrainer shall accommodate the full working pressure rating of the pipe plus surge allowance. In the assembly of the restraint device, the contractor shall tighten the bolts to the correct torque range as recommended by the restraint manufacturer. The restrainers shall be painted black for ductile iron pipe and painted red for PVC pipe applications. Restrainers shall be properly stored to minimize sand and debris build-up. Specifically the twist-off-screws and associated threads shall be clean (free of sand) prior to installation.

### **II.3.10. PIPE COUPLINGS**

The Contractor shall furnish and install pipe couplings as required to complete the work. Pipe couplings used to join two pieces of PVC pipe shall be sized to match the outside diameter of the pipeline. Transition couplings shall be used to join pipes of different outside diameters. The coupling sleeve shall be manufactured of ductile iron conforming to ASTM A536 and shall be coated with nominal 14 mils of epoxy as set forth in Section II.4. The bolts shall be manufactured of a metal of high corrosion resistance and shall conform to ANSI 21.11 (AWWA C111). Gaskets shall be wedge-type and manufactured of virgin SBR for water and wastewater service. The installation of all couplings shall be in accordance with manufacturer's recommendations. Couplers and adapters for polyethylene pipe shall be brass conforming to AWWA C800 and shall be female IPT, pack joint or compression nut.

### **II.3.11. FULL CIRCLE REPAIR CLAMPS**

Full circle repair clamps shall have type 304 stainless steel shells, lugs, bolts, nuts and washers as per ASTM A193, A194, A240, or shall have type 304 stainless steel shells per ASTM A240, ductile iron lugs as per ASTM A536, and 304 stainless steel bolts, washers and nuts. Gaskets for both types shall be virgin SBR as per ASTM D2000 for water service. Minimum lengths shall be 7½" long for 6" nominal and smaller pipe, 12" long for 8" – 12" nominal pipe and 20" long for pipes larger than 12" nominal pipe.

### **II.3.12. STAINLESS STEEL FLEXIBLE JOINT**

Flexible joints are intended for use in joining stainless steel pipe in a piping system where axial movement due to thermal expansion and contraction is required. The design engineer shall provide summary of design axial movement calculations on the construction plans and specific installation instructions for the contractor regarding the impact of outdoor temperature during the construction period. The actual construction shall be in accordance with the flexible joint manufacturer. Flexible

# *JEA Water and Wastewater Standards*

## *429 Wastewater Force Mains*

Joints shall be flexible expansion joint type manufactured of ductile iron conforming to ASTM A-536. Flexible Joints shall have flanged ends meeting ANSI Class 125. Each flexible expansion joint shall consist of an expansion joint designed and cast as an integral part of a ball and socket type flexible joint with deflection capability. All integral surfaces (wetted parts) shall be lined with 12 mils (min) of fusion bonded epoxy. The exterior surfaces shall be lined with 6 mils (min) of fusion bonded epoxy. Sealing gaskets shall be constructed of EPDM. Bolts and other hardware shall be 316L stainless steel.

### **II.4. CORROSION PROTECTION FOR DUCTILE IRON PIPE AND FITTINGS**

#### **II.4.1. INTERIOR LINING**

The interior of all ductile iron pipe and fittings shall be furnished with an approved amine cured novalac epoxy coating.

##### **II.4.1.1. Lining Material**

The material shall be an amine cured novalac epoxy containing at least 20% by volume of ceramic pigment. The lining material shall comply with the following properties:

II.4.1.1.1. ASTM D-1653 Permeability, Method A 40-mils free cast film 30-day duration. 0.00 perms.

II.4.1.1.2. The following test must be run on coupons from factory lined Ductile Iron Pipe.

II.4.1.1.2.1. ASTM B 117-85 Salt Spray (scribed panel) – Results to equal 0.0 undercutting after two years.

II.4.1.1.2.2. ASTM D-4541 Adhesion 700 psi minimum.

II.4.1.1.2.3. ASTM G-95 Cathodic Disbondment shall be not greater than 0.5mm disbondment, 30 days duration.

II.4.1.1.2.4. Immersion Testing rated using ASTM D-1308 evaluated by ASTM D-714

- 20% Sulfuric Acid @ 77° F with no effect after 2 years.
- 140°F-25% Sodium Hydroxide – No effect after two years.
- 160°F Distilled Water – No effect after two years.
- 5% Sodium Chloride Solution @ 77° F No- effect after 2 years

II.4.1.1.2.5. ASTM D-4060 Abrasion Resistance shall not exceed a weight loss of more than 0.30 grams (CS17 Wheel, 1000-gram load, 1000 cycles).

II.4.1.1.2.6. ASTM G-53-77 Moisture/UV Light. UVB-313 Bulb. Cycle-8 hrs. UV @ 60° C followed by 100 % Humidity @ 40° C. 1 year – pass, no crazing, cracking, or loss of adhesion.

II.4.1.1.2.7. ASTM D-2794 Direct Impact Resistance 140 in./lbs. minimum.

##### **II.4.1.2. Application**

II.4.1.2.1. Applicator



# *JEA Water and Wastewater Standards*

## *429 Wastewater Force Mains*

The lining shall be applied by a competent firm, who has been certified acceptable by the lining manufacturer with a successful history of applying linings to the interior of ductile iron pipe and fittings.

### II.4.1.2.2. Surface Preparation

Prior to abrasive blasting, the entire area to receive the protective compound shall be inspected for oil, grease, etc. Any areas where oil or grease is present, or any substance which can be removed by solvent, shall be solvent cleaned using the guidelines outlined in DIPRA- 1 Solvent Cleaning, NAPF 500-03-01. Per guidelines outlined in NAPF 500-03-04 or NAPF 500-03-05. After the surface has been made free of grease, oil or other substances, all areas to receive the protective compounds shall be abrasive blasted using compressed air nozzles with sand or grit abrasive media. The entire surface to be lined shall be struck with the blast media so that all rust, loose oxides, etc., are removed from the surface. Only slight stains and tightly adhering annealing oxide may be left on the surface. Any area where rust reappears before lining must be re-blasted. Abrasive blasting of previously lined pipe or fitting (including cement lined materials), is not acceptable. Only virgin metal materials will be utilized in the lining process.

### II.4.1.2.3. Lining

Within eight (8) hours of surface preparation, the interior of the pipe and fittings shall receive nominal 40 mils (minimum), couplings/sleeves shall receive nominal 14 mils, and bell and spigot shall receive 6-10 mils maximum of joint compound, normal dry film thickness of the approved lining. No lining shall be applied when the substrate or ambient temperature is below 40 degrees Fahrenheit. The surface also must be dry and dust free. If flanged pipe or fittings are included in the project, the lining shall not be used on the face of the flange. Upon completion of the blast cleaning operation, the lining material should be applied to the interior of the pipe within 12 hours in order to avoid any possible post blast surface contamination. Any area found to have rust bloom prior to application must be re-blasted.

### II.4.1.3. Number Of Coats

The number of coats of lining material applied shall be as recommended by the lining manufacturer. However, in no case shall this material be applied above the dry thickness per coat recommended by the lining manufacturer in printed literature. The maximum or minimum time between coats shall be that time recommended by the lining manufacturer.

### II.4.1.4. Rough-Up & Repair

JEA will not accept damaged or touched-up epoxy lined materials nor will JEA allow field repairs. Field touch-up exceptions may be allowed for field cutting only. Touch-up shall be performed by a certified epoxy-trained applicator with a valid certification card. Touch-up shall be performed in accordance with the lining manufacturer's recommendations.

# JEA Water and Wastewater Standards

## 429 Wastewater Force Mains

### II.4.1.5. Inspection and Certification

JEA may require the contractor to provide the following inspection if a quality concern exists in the field:

II.4.1.5.1. Epoxy lined ductile pipe and fittings shall be inspected for foundry defects. If any defects are found, the pipe or fitting shall be replaced with a new pipe or fitting.

II.4.1.5.2. Ductile iron pipe and fitting linings shall be checked for thickness using a magnetic film thickness gauge. The thickness testing shall be performed using the method outlined in SSPCPA-2 Film Thickness Rating.

II.4.1.5.3. The interior lining of all pipe and fittings shall be tested for pinholes with a nondestructive 2,500 volt test. If any defects are found, the pipe or fitting shall be replaced with a new pipe or fitting

II.4.1.5.4. Each pipe, pipe joint and fitting shall be marked with the date of application of the lining system along with its numerical sequence of application on that date, the manufacturer date of the pipe or fitting and the applicator's certification number. All records of the work shall be maintained by the applicator.

Example:

Date of lining (L)	L-08-19-17
Date of Manufacturing (M)	M-06-19-17
Sequence Number (S)	S-1-4
Applicator's Number (A)	A-4
Manufacturer's Name	USP

II.4.1.5.5. No pipe, pipe joint, or fitting shall be accepted if the date of application of the lining system and the date of manufacture of the pipe, pipe joint, or fittings differs by more than two (2) years.

### II.4.1.6. Handling (At The Factory and In The Field)

The lined pipe and fittings must be handled only from the outside of the pipe and fittings. No forks, chains, straps, hooks, etc. shall be placed inside the pipe and fittings for lifting, positioning, or laying. If damaged, the pipe or fittings shall be replaced.

### II.4.1.7. Warranty

A minimum three (3)-year above ground storage replacement warranty and a two (2)-year in-ground warranty, on the serviceability of the lining, shall be furnished by the lining manufacturer on the serviceability of the liner. The lining manufacturer shall provide annual inspections, within the JEA service area, to assure above ground serviceability of the lining and provide documentation of such to the JEA Water Wastewater Standards. This warranty shall include but not be limited to, statements that at any time up to the end of the year from the date of project acceptance:

II.4.1.5.1. The lining shall not have disbonded.

II.4.1.5.2. The lining shall not have suffered any appreciable under film migration.

# *JEA Water and Wastewater Standards*

## *429 Wastewater Force Mains*

II.4.1.5.3. The interior pipe metal, at points of pinholes or holidays, shall not have suffered detrimental deterioration.

II.4.1.5.4. The lining shall have maintained its smooth surface characteristics.  
The Contractor and/or lining manufacturer shall not make any exemption or exception to the above stated conditions or warranty within the limits as stated in this section of these specifications.

### **II.4.2. EXTERIOR COATING**

All ductile iron pipe and fittings, except as otherwise noted, shall receive an exterior bituminous coating as specified in ANSI A21.51. The finish coating shall be continuous smooth, neither brittle when cold nor sticky when exposed to the sun, and be strongly adherent to the fitting. If the pipe is installed in corrosive soils, then all bolts, nuts, studs and other uncoated parts of joints for underground installation shall be coated with asphalt or coal-tar prior to backfilling. Corrosive soil shall be defined as described in AWWA C105, appendix "A".

### **II.4.3. POLYETHYLENE WRAP**

In areas where soils are corrosive in nature, ductile iron pipe, fittings, valves and other appurtenances shall be protected with polyethylene wrap or tubing. Corrosive soil shall be defined as described in AWWA-C105, appendix "A". The Contractor shall furnish and install polyethylene tube or wrap for ductile iron pipe at the locations shown on the construction drawings or as directed by JEA.

#### **II.4.3.1. Material**

The polyethylene material shall meet or exceed the requirements of AWWA C105 in all respects. The wrap shall be virgin, high density polyethylene, 4 mils thick minimum cross laminated type or 8 mils linear low density tape. The polyethylene wrap shall include industrial standard repeatable message (green color).

#### **II.4.3.2. Installation**

Although not intended to be a water-tight enclosure, the polyethylene shall prevent contact between the pipe and the surrounding backfill. Installation shall be done according to one of the methods described in Section 5.4 of AWWA C105, subject to approval by the engineer and the manufacturer.

### **II.5. MARKING FOR 2" PVC PIPE**

All 2" PVC pipe below ground shall be marked with a 3 inch wide (minimum), non-detectable utility marking tape (tape with an adhesive backing). The utility marking tape shall be installed on the pipe at the 12:00 o'clock position. Tape shall be 4 mil (minimum) ASTM D2103 thickness constructed for prolonged use underground, meet the industry standards (APWA) color code, tensile strength of 2750 psi (ASTM D882), and industrial standard repeatable message. All pipe above ground (including bridge crossing) shall be color labeled "WASTEWATER" stenciled in the center of each joint of pipe utilizing an oil-based paint. Stenciled lettering shall be 4" (minimum), high lettering and be green color. All fittings (above ground or below ground) shall be labeled "WASTEWATER", or marked with green paint (6 inch diameter solid circle, minimum), within 48 hours after site delivery. By properly marking the ductile fittings, this will assure that only wastewater fittings will be utilized on the force main system.

# *JEA Water and Wastewater Standards*

## *429 Wastewater Force Mains*

### **II.6. PIPING SUPPORTS**

The Contractor shall furnish and install all supports necessary to hold the piping and appurtenances in a firm, substantial manner at the lines and grades indicated on the drawings or as specified. Piping within pumping stations shall be adequately supported from floors, walls, ceilings or beams. Supports from the floor shall be by approved saddle stands or suitable concrete piers as indicate or approved. Pipe saddles shall be shaped to fit the pipe with which they will be used and shall be capable of screw adjustment. Concrete piers shall conform accurately to the bottom one-third to one-half of the pipe. Piping along walls shall be supported by approved wall brackets with attached pipe rolls or saddles or by wall brackets with adjustable hanger rods. For piping supported from the ceiling, approved rod hangers of a type capable of screw adjustment after erection of the piping and with suitable adjustable concrete inserts or beam clamps shall be used. If required, piping supports shall be placed so as to provide a uniform slope in the pipe without sagging. Supports shall be located wherever necessary, and in no case shall they exceed 8 feet on centers for stainless steel pipe and 4 feet on centers for PVC pipe.

#### **II.6.1. STAINLESS STEEL PIPE SUPPORT**

Pipe Supports: Pipe supports shall be in accordance with JEA Water and Wastewater Standards Manual, but modified to match the outside diameters (OD) of stainless steel pipe. The design engineer shall also provide base support to handle the weight of the flexible joint, if required (especially for couplings larger than 8" size). Other pipe support systems must be approved by JEA prior to construction.

#### **II.6.2. CASING SPACERS**

Casing spacers shall be a two piece prefabricated unit by a single manufacturer. All casing spacers in a single casing pipe crossing shall be by the same manufacturer. Casing spacers shall have a shell made from either 304 stainless steel, 14-gauge mild steel which has been heat fusion coated with PVC plastic, (PVC coating shall be .01 inch thick over the entire band including the runner studs) or high density polyethylene. Casing spacers on 16 inch and smaller carrier pipe shall have 8-inch wide steel bands and casing spacers on 18-inch and larger carrier pipe shall have 12-inch wide steel bands, except high density polyethylene spacers shall have high density polyethylene bands. All casing spacers for 14-inch and smaller pipe size shall have four 10- gauge or 14-gauge steel risers with runners and casing spacers for 16-inch and larger pipe shall have six 10-gauge or 14-gauge steel risers with runners (two top and four bottom), except high density polyethylene spacers shall have one riser for every diameter inch of carrier pipe. The runners (risers) shall be either glass reinforced plastic, UHMW polymer or high density polyethylene. All nuts, bolts and washers shall be 304 stainless steel. All risers over 2 inches in height shall be reinforced. Wooden skids are not an acceptable alternate.

### **II.7. LOCATE WIRE**

#### **II.7.1. MATERIAL**

II.7.1.1. Locate wire shall be 12 gauge, copper wire with .03 inches (minimum) HDPE insulation thickness, .141 inches (minimum) O.D. rated break load 250 lbs., 30 volt, and 21% IACS.

II.7.1.2. The outside color of the wire shall be as follows:

- Green for wastewater force mains
- Blue for potable water mains and services

# JEA Water and Wastewater Standards

## 429 Wastewater Force Mains

- Purple for reclaimed water mains and services
- White for Chilled water lines

### II.7.2. REQUIREMENT

- II.7.2.1. Locate wire shall be installed on all wastewater force main piping, potable water main piping, reclaimed water main piping, potable water services 10-LF or greater in length, and reclaimed water services 10-LF or greater in length.
- II.7.2.2. No locate wire shall be installed on above ground installations.
- II.7.2.3. Refer to details for minimum installation requirements.

### II.8. MATERIAL TESTING

JEA will perform random testing of all materials furnished for Conformance to the following standards. The entire product of any manufacturer or of any one plant may be rejected when, in the opinion of JEA, the methods of manufacture fail to secure uniform results acceptable to the requirements of these specifications. Pipe and materials shall be tested in, and for conformity with, the latest editions of the following:

Material	Specifications
Ductile Iron Fittings	ANSI A21.50 (AWWA C150)
	ANSI A21.51 (AWWA C151)
	ANSI A21.53 (AWWA C153)
	ANSI A21.40 (AWWA C104)
	ANSI A21.50 (AWWA C105)
	ANSI A21.10 (AWWA C110)
	ANSI A21.15 (AWWA C115)
Polyvinyl Chloride Pipe and Fittings	ASTM D1598
	ASTM D1599
	ASTM D1784
	ASTM D1785
	ASTM D2122
	ASTM D2241
	ASTM D2564
	ASTM D2672
	ASTM D2837
	ASTM D2855
	ASTM D3139
	ASTM F477
	AWWA C900
	AWWA C905
AWWA C907	
Polyethylene Tubing	ASTM D1248
	ASTM D2239

# *JEA Water and Wastewater Standards*

## *429 Wastewater Force Mains*

	ASTM D2737
	ASTM D3350
	AWWA C901

### III. INSTALLATION

#### III.1. REFERENCE POINTS AND LAYOUT

The Contractor shall be responsible for setting all grade, lines and levels. The Contractor or Contractor's Surveyor will provide centerline of construction and will establish a bench mark. Any reference points, points of intersection, property corners, or bench marks, which are disturbed during construction, shall be restored by a Land Surveyor registered to practice in the State of Florida, and all costs thereof shall be borne by the Contractor. The Contractor shall assume all responsibility for the correctness of the grade and alignment stakes.

#### III.2. HANDLING AND CUTTING PIPE

Transport, handle and store pipe materials and other products specified herein in a manner recommended by the respective manufacturers to prevent damage and defects. Handling and storage shall be in accordance with Chapter 6 of AWWA Manual M23 and AWWA C605. Procedures "recommended" in these AWWA publications shall be mandatory. Every care shall be taken in handling and laying pipe and fittings to avoid damaging the pipe, scratching or marring machined surfaces, and abrasion of the pipe coating. The lined Pipe and Fittings must be handled only from the outside of the pipe and fittings. No forks, chains, straps, hooks, etc. shall be placed inside the pipe and fittings for lifting, positioning, or laying. If damaged, the material shall be repaired in accordance with the liner manufacturer's recommendations. Any fitting showing a crack and any fitting or pipe which has received a severe blow that may have caused an incipient fracture, even though no such fracture can be seen, shall be marked as rejected and removed at once from the work. In any pipe showing a distinct crack in which it is believed there is no incipient fracture beyond the limits of the visible crack, the cracked portion, if so approved by JEA, may be cut off before the pipe is laid so that the pipe used shall be perfectly sound. The cut shall be made in the sound barrel at a point at least 12 inches from the visible limits of the crack. Except as otherwise approved, all cutting shall be done with a power driven cut off saw. All cut ends shall be examined for possible cracks caused by cutting. All PVC pipe shall be inspected by the JEA Representative prior to installation.

#### III.3. PIPE INSTALLATION

##### III.3.1. GENERAL REQUIREMENTS

The JEA Representative will perform supplemental inspection as described herein for all PVC pipe sections (each 20-ft or less pipe length) installed by the Contractor for the following tasks: unloading, storage, pipe stringing, joint preparation, lowering pipe in trench, assembly, installation of joint restraints, and testing. Any damaged pipe shall be replaced at no additional cost to the JEA. Force mains shall be constructed of the materials specified and as shown on the drawings. All PVC C900/C905 pipe shall be laid in accordance with AWWA C605. Pipe and fittings shall be carefully handled to avoid damage, and if feasible, while they are suspended over the trench before lowering, they shall be inspected for defects and to detect cracks. Defective, damaged or unsound pipe or fittings shall be rejected. Each section of the pipe shall rest upon the pipe bed for the full length of its barrel, with recesses excavated to accommodate bells and joints. Any pipe which has its grade or joint disturbed after laying shall be taken up and re-laid. Only suitable soils (no heavy clay) shall be utilized in the backfill operation up to 12 inches above the pipe. The maximum joint deflection shall be limited to 80% of the pipe manufacturer's recommendation. All precautions shall be taken

# *JEA Water and Wastewater Standards*

## *429 Wastewater Force Mains*

to prevent sand or other foreign material from entering the pipe during installation. If necessary, a heavy, tightly woven canvas bag of suitable size shall be placed over each end of the pipe before lowering into the trench and left there until the connection is made to the adjacent pipe. Any time the pipe installation is not in progress, the open ends of pipe shall be closed by a watertight plug or other method approved by the Engineer. Plugs shall remain in pipe ends until all water is removed from the trench. Any sand or foreign material that enters the pipe shall be removed from the pipe immediately. No pipe shall be installed when trench conditions (standing water, excess mud, etc.) or the weather (rain, etc.) is unsuitable for such work, except by permission of the JEA. If, in the opinion of the JEA representative, significant quantities of sand or foreign materials enter the new sewage force main during the construction period, the contractor will be required to flush the system with clean water. The flushing operation, if required, shall be as directed by JEA and shall be accomplished at no additional cost to JEA. The water utilized in the flushing operation shall be provided and paid for by the contractor. Any section of pipe already laid which is found to be defective or damaged shall be replaced with new pipe. The contractor shall coordinate utility locate with Sunshine State One-Call of Florida, Inc. (#811 or website [www.callsunshine.com](http://www.callsunshine.com)), at a minimum. The use of 90 degree bends 24-inch and larger size shall be avoided if possible (two 45 degree bends or other method is preferred).

### **III.3.2. SPECIAL CONSTRUCTION REQUIREMENTS FOR 24-INCH AND LARGER PVC PIPE**

The Contractor shall provide an experienced PVC pipe Superintendent/Foreman and submit to the JEA Representative their experience record.

### **III.3.3. TRENCH WORK**

The laying of PVC pipe, fittings, specials, closures and appurtenances (called pipe hereinafter) in trenches shall be to the lines and grades shown on the Drawings and in accordance with the applicable requirements JEA Water and Wastewater Standards Manual:

#### **III.3.3.1. Clean Pipe**

All pipes shall be checked and cleaned of all dirt, dust, grease, oil, water, debris, etc. before it is lowered into the trench. It shall be placed directly into position. If any dirt enters the pipe during placement operations, it shall be immediately removed. In no case shall the pipe be allowed to slide along the bottom of the trench. It shall be placed directly into position.

#### **III.3.3.2. JEA Detail Adherence**

All trenching and backfill operations shall be in accordance with the details on the Drawings and JEA Water and Wastewater Standards Manual: Excavation and Earthwork-Section 408.

#### **III.3.3.3. Lay Schedule**

The open trench shall be no more than the footage of pipe that can be laid in a day. All pipe shall be assembled in the pipe trench to predetermined lines and grades as indicated by the Drawings or established in the field by the JEA Representative with an absolute minimum of three feet of cover, unless shown differently on the Drawings or approved in isolated areas by the JEA Representative.

#### **III.3.3.4. Line And Grade**

The trench bottom shall be brought to specified and indicated line and grade as outlined in JEA Water and Wastewater Standards Manual: Sewage Force Mains-Section 429,

# *JEA Water and Wastewater Standards*

## *429 Wastewater Force Mains*

and Excavation and Earthwork-Section 408 and as shown on the Drawings. Holes on the bottom and side of the trench shall be dug at no additional cost to the JEA to accommodate joint assembly (pipe bells, mechanical couplings, or mechanical restraints as specified). Final line and grade shall be accomplished through the excavation or the addition of approved material adequately compacted. In no case shall pressure be applied directly to the pipe by mechanical means, such as the use of backhoe buckets, to accomplish final line and grade.

### III.3.3.5. Trench Width

Trench width shall be in accordance with the details on the Drawings and JEA Water and Wastewater Standards Manual: Excavation and Earthwork-Section 408, except that the minimum width shall be wide enough to accommodate the compaction equipment within the haunch zone between the pipe wall and trench side.

### III.3.3.6. Bedding And Backfill

Pipe embedment and backfilling shall closely follow the installation and jointing of PVC pipe in the trench, to prevent flotation of the pipe by water which may enter the trench and to prevent longitudinal movement caused by thermal expansion or contraction of the pipe.

### III.3.3.7. Removal of Defective Pipe

Any pipe that has its grade or joint disturbed after laying shall be taken up and re-laid. The joint gasket shall be removed and a new one installed. Any section of pipe already laid and found to be defective shall be taken up and replaced with new pipe at no additional cost to the JEA.

### III.3.3.8. Plugging Ends

At times when pipe laying is not in progress, the open ends of the pipe shall be closed by gasketed watertight plugs. Plywood is not acceptable for this purpose.

### III.3.3.9. Stringing Pipe

The Contractor shall place the pipe near the trench on the opposite side of the excavated earth. Point the bell end in the direction of work progress.

#### III.3.3.9.1. Pipe Ovality Check

Prior to placing the pipe in the trench, the JEA Representative shall inspect the pipe segment at both ends to check for pipe ovality. If the pipe reflects this condition, it is defective and shall be removed from the Work, and replaced with a new section at no additional cost to JEA.

#### III.3.3.9.2. Spigot Inspection Mark

Prior to placing the pipe in the trench, the Contractor shall place a permanent mark at the spigot end around the circumference of the pipe at the distance specified by the manufacturer for insertion into the bell end. This must be done in the presence of the JEA Representative, who will verify the distance specified by the manufacturer. If the insertion mark is incorrect, the JEA Representative will place an "X" over the mark, and the



# *JEA Water and Wastewater Standards*

## *429 Wastewater Force Mains*

Contractor shall completely remove it, and repeat the procedure to place a new mark at the correct location.

### III.3.3.10. Gaskets

Before assembly of the pipe in the trench, the JEA Representative shall inspect every gasket to confirm that it is positioned properly. If it is twisted or pushed out of its seat ("fish mouthed"), the Contractor shall reinsert the gasket so that it is positioned properly. If the gasket cannot be reinserted, then it shall be replaced at no additional cost to the JEA.

### III.3.3.11. Lubrication

Prior to lubrication, the pipe gasket, and spigot and bell ends, shall be checked and cleaned of all dirt, dust, grease, oil, water, debris, etc. before applying lubricant. Once cleaned, an even, uniform application of gasket lubricant must be applied to the bevel and spigot to the insert reference mark as well as the contact surface of the gasket. Gasket lubricant may be applied with a swab, brush, or roller. The joint lubricant must be supplied by the pipe manufacturer. Application of lubricant shall be as recommended by the manufacturer. Lubrication must be done in the presence of the JEA Representative for every pipe joint.

### III.3.3.12. Use of Construction Equipment

During pipe assembly, if construction equipment will be used to "push" the spigot end into the pipe bell, it must be approved by the JEA Representative prior to use. In no case, shall the equipment be of such a size as to cause the spigot end to be over inserted beyond the reference mark.

### III.3.3.13. Pipe Assembly

Assembly of the pipe is made by sliding the lubricated spigot end into the gasketed bell end. Assembly of all pipe sections, fittings, specials and valves must be done in the presence of the JEA Representative.

#### III.3.3.13.1. Step 1

Align the spigot and bell ends and insert the spigot end into the bell so that it is in near contact with the gasket. Keep the pipe lengths in proper alignment. Do not allow the lubricated section touch the dirt or backfill as foreign material could adhere to the surface and compromise joint integrity.

#### III.3.3.13.2. Step 2

Brace/Anchor the pipe bell while the spigot end is pushed through the gasket so that previously completed joints in the line will not be "stacked," "over-belled", or inserted past the reference mark. The method of bracing/anchoring the pipe bell shall be approved by the JEA Representative prior to use.

#### III.3.3.13.3. Step 3

# *JEA Water and Wastewater Standards*

## *429 Wastewater Force Mains*

Push the spigot end in until the reference mark on the spigot end is flush with the end of the bell and is clearly visible outside the entry lip of the socket.

### III.3.3.13.4. Step 4

If the pipe joint requires barring to seat the joint, use a wood block to protect the end of the pipe. A come-a-long is recommended to seat the joint. The method of using a swinging stab is not allowed.

### III.3.3.14. Over-Insertion Of Spigot End

If the insertion mark is not visible after assembly, the pipe was over-inserted. The Contractor shall disassemble the joint, and the JEA Representative shall inspect both the spigot and bell ends to verify the interiors are clean and that no damage was done to the pipe or gasket. If the gasket is twisted or pushed out of its seat ("fish mouthed"), determine if it can be repaired, and if not, replace with a new one. If the pipe is damaged, the Contractor shall remove the damaged section and replace with a new one at no additional cost to the JEA. If there is no damage to the pipe, the Contractor shall reassemble the joint in accordance with the procedures described herein.

### III.3.3.15. Pipe Restraints

Restraints for pipe joints (bell/spigot), fittings, couplings, specials, and valves shall be installed per the manufacturer's recommendations. The Contractor shall provide a calibrated torque wrench/gauge for accurately measuring the torque on all bolts and threaded rods used to secure the restraints. Assembly of all restraints must be done in the presence of a JEA Representative.

### III.3.3.16. Pipe Joints (Bell/Spigot)

The split retainer ring or non-split retainer ring type of restraint must be installed on the assembled pipe bell and spigot ends per the manufacturer's recommendations. If the restraint uses machined serrations for positive restraint, it must be oriented in the proper direction to resist pullout of the joint or fitting. Do not exceed the maximum distance between the retainer rings on each side of the joint. The threaded rods used to connect the restraints must contain two (2) nuts on each end of the rod. One nut on each rod shall be installed on the "inside" of each retainer ring to insure proper spacing and alignment and to provide a "stop" when torquing the "outside" nut, thereby preventing over homing of the pipe joint. The second nut ("outside" one) on the threaded rod must be tightened to the "seating" torque value for the size of rod used as shown in Table 1 herein. The "inside" nuts may be "hand" tightened. Tighten all "outside" nuts on threaded rods evenly using a calibrated torque wrench/gauge to recommended torque values. Locking washers shall be used on both "inside" and "outside" nuts. Loctite or equal shall be applied to both the "inside" and "outside" threaded rods.

### III.3.3.17. Fittings, Couplings, Specials And Valves

Mechanical joint restraining glands at fittings, couplings, specials and valves must be installed per the manufacturer's recommendations. Tighten all bolts and threaded rods evenly using a torque wrench/gauge to recommended torque values. The table below gives values for "seating" torque for rods to be used for securing the restrainer ring on

# *JEA Water and Wastewater Standards*

## *429 Wastewater Force Mains*

each side of a pipe joint. Tighten all bolts and threaded rods evenly using a calibrated torque wrench/gauge to "seating" torque values.

**Table 1 Seating Torque for Threaded Rods**

Threaded Rod Dia. (inch)	Seating Torque (ft-lbs)
1 x 40	75
1-1/4 x 32	90

### III.3.3.18. Field-Cutting Pipes And Ends

#### III.3.3.18.1. Field Conditions

Closures and short sections of pipe shall be installed by the Contractor as found necessary due to deviating field conditions at no additional cost to the JEA

#### III.3.3.18.2. Field-Cut

If the pipe must be field-cut to achieve the proper pipe length or closure piece, the Contractor shall use the proper equipment for making square cuts and bevels (if necessary). Prior to cutting the pipe, the Contractor shall mark the entire circumference of the pipe to ensure a square cut. After the cut is completed and the bevel cut or rounded, the Contractor shall place a permanent mark at the spigot end around the circumference of the pipe at the distance specified by the manufacturer for insertion into the bell end. All work shall be done per the manufacturer's recommendations.

### III.3.3.19. Backfill

Backfill shall be done in accordance with the applicable requirements of the JEA Water and Wastewater Standards Manual: Excavation and Earthwork-Section 408. The JEA Representative must be present throughout the entire backfill operation and at all density testing.

### III.3.3.20. PVC Pipe 20-Inch and Larger

For PVC pipe 20-inch and larger, unless approved otherwise by JEA, a foundation bed of granular material (57 stone) shall be placed under and around all ductile iron fittings and valves for additional support of heavy system components. A foundation bed of granular material shall be provided for all valves 20-inch size and larger. For granular materials, the minimum vertical limit is 12 inches under the fitting or valve, up to 1/3 the overall height of the fitting or valve. The minimum horizontal limits of the granular material shall be 12 inches in all directions beyond the outer edges of the fitting or valve. The compaction of soils below the granular material shall be at 98% of the maximum density. All spool pieces between 20-inch and larger stainless steel fittings and valves shall be at least 5 feet long. Where possible, a full joint of pipe (no short pipe lengths) shall be connected to all fittings and valves. No joint deflection shall be allowed at the fittings or valves.

### III.3.3.21. Construction Sequence

# JEA Water and Wastewater Standards

## 429 Wastewater Force Mains

The Contractor shall install the force main pipe and complete all testing in lengths no longer than allowed in the JEA Water and Wastewater Standards. Contractor shall not install sleeves in the pipeline that are not shown on the drawings. Pipeline segments consist of a gate valve on each end with the connecting pipe in-between. In some cases, the Contractor shall furnish and install temporary plugs/caps, pipe end (stub-outs) sections, and other items as necessary to accommodate the testing sequence at no additional cost to the JEA.

### III.3.3.22. Pipeline Testing

Following the installation and completion of each pipeline segment, including trench backfill, the Contractor shall immediately test that segment of pipeline. The Contractor may continue to install pipe in the next segment during the testing phase. If the pipe segment undergoing testing fails any one test, then the pipe laying in the next segment shall be immediately stopped. No further pipe laying shall be allowed until the pipeline segment undergoing testing passes all three tests. Pipeline testing consists of pressure and leakage; locate wire; and density tests. The tests shall be done in accordance with the JEA Water & Wastewater Standards Manual: Excavation and Earthwork-Section 408, and Sewage Force Mains-Section 429, latest edition. All tests shall be done in the presence of a JEA Representative."

### III.3.3.23. Pipe Cover

The cover over all piping less than 24-inch size shall be a minimum of 30 inches in unpaved areas and 36 inches in paved areas with a maximum of 60 inches, unless approved otherwise by JEA. The cover over all piping 24-inch size or greater shall be 36 inches (paved or unpaved areas), with a maximum of 84 inches, unless approved otherwise by JEA. Cover for pipe under pavement shall be measured from the finished grade. Any reduction in pipe cover will require approval from JEA and the Engineer. Greater depths will be permitted where required to miss obstructions only. Lines shall be located as shown on the drawings. The Contractor shall investigate well in advance of pipe laying any conflicts which may require readjustments in planned locations and advise the Engineer of the results of these investigations so that the Engineer may give instructions as to the modifications required. Refer to Chapter II. 3. - Section 408 for backfill and compaction requirements.

### III.3.4. THRUST RESTRAINT

All non-flanged fittings and valves shall be restrained using one of the following methods:

III.3.4.1. Mechanical restraint at fittings and valves and mechanical restraint along adjacent joints of pipe to a length as specified in the Restraint Joint Schedule (see Plate No. S-38A), at a minimum.

III.3.4.2. Mechanical joint fittings and valves shall be restrained using an approved restraining device and/or tie rods along adjacent joints of pipe to a length as specified. Tie rods shall be as follows, at a minimum:

PIPE SIZE	NO. OF RODS	ROD SIZE
4	2	¾
6	2	¾
8	2	¾

# JEA Water and Wastewater Standards

## 429 Wastewater Force Mains

10	4	¾
12	4	¾
14	6	¾
16	6	¾
18	8	¾
20	8	¾
24	12	¾
30	14	1
36	14	1
42	16	1 ¼
48	16	1 ¼
54	18	1 ¼

To connect tie rods to fitting, offset eyebolts shall be used. Tie rods shall be (core 10 steel or 316 S.S.) threaded as required, installed with a washer and nut (same material as the rod) on either side of the joint.

III.3.4.3. The use of thrust blocks shall be limited to situations such as point repair where exposing several joints of pipe is not feasible due to existing ground conditions and also must be used with mechanical joint restraining devices when, in the judgment of the Engineer, the nature and criticality of an installation is such as to require positive assurance of stability. Concrete collars with tie rods may be used on dead end lines at the Contractor's discretion. Concrete used for this purpose shall be 2,500 psi minimum. When applicable, schedule and details for the required thrust blocks are included on the drawings (see Plate No. S-45). The JEA Standard Details show minimum size thrust blocks for use in good soil. Poor soils will require larger thrust blocks.

#### III.3.4.4. Joint Restraints Within Carrier Pipe

All joints within steel casing pipe shall be restrained with mechanical restraining devices. End joints shall be tie rodded, with the ends of the rods welded to the end of the casing.

#### III.3.4.5. Casing Spacer Installation

All carrier pipes in casings shall utilize casing spacers installed on the carrier pipe, inside the casing pipe. Casing spacers shall be installed one foot on both sides of each carrier pipe joint, and at ten feet intervals along the carrier pipe for pipe up to 48 inches. For carrier pipes larger than 48 inches, casing placement shall be as recommended by the casing spacer manufacturer. A casing spacer shall also be installed within two feet of each of the ends of the casing pipe.

### III.4. REQUIRED PIPE SEPARATIONS

#### III.4.1. SEWAGE FORCE MAIN AND WATER MAIN SEPARATION REQUIREMENTS

The minimum separation requirements between sewage force mains and water mains shall be as outlined in specification Chapter III. 4 - Section 350 and Detail Nos. S-26 and S-27. The table

# JEA Water and Wastewater Standards

## 429 Wastewater Force Mains

below provides the minimum horizontal separation requirements between the proposed utility and structures (see notes).

Pressure Main (water & wastewater) Nominal Size (inches) (See note 1)	Horizontal Separation Requirements (min)
up to 6"	10 feet
8"	14 feet
10"-12"	18 feet
14" and larger	See note 4
For gravity wastewater mains, see note 2.	

Notes:

- III.4.1.1. The table above provides the minimum horizontal separation requirements between the proposed JEA maintained utilities (including water mains, reclaimed water mains, water service laterals, meter boxes and wastewater force mains) and existing, proposed and future structures (including above ground structures, concrete footers and top of bank of ponds).
- III.4.1.2. For gravity wastewater mains, the horizontal separation from existing, proposed and future structures (including above ground structures, concrete footers and top of bank of ponds) shall be a minimum of 3 times the vertical depth of the deepest portion of the manhole to manhole wastewater run.
- III.4.1.3. Pressure mains with pipe cover greater than 36 inches will require additional horizontal separation as reviewed and approved by JEA.
- III.4.1.4. Pressure mains 14 inch and larger will require additional horizontal separation as reviewed and approved by JEA.
- III.4.1.5. All depth measurements will be based upon final finished grade elevations, unless approved otherwise by JEA.

### III.4.2. SEPARATION FROM HARDWOOD TREES

- III.4.2.1. The planting of hardwood trees (see listing below) within 36 inches (horizontal clearance) of the outside surface of the pressure main and the tree trunk or the installation of a pressure main within 36 inches (horizontal clearance) shall be prohibited. Service lines are excluded from this requirement. The planting of hardwood trees with a horizontal clearance between 3 and 6 feet or the installation of a pressure main between 3 and 6 feet from the outside surface of the tree trunk shall require root barrier material to isolate the main from future root growth. The root barrier (cut-off wall) shall be solid plastic or HDPE (0.0276" or 0.7 minimum thickness). The root barrier shall be installed/extended to all areas where the above clearances cannot be met. The root barrier shall extend vertically from the bottom of the pressure main to within 6 inches from top of finished grade, at a minimum.

# JEA Water and Wastewater Standards

## 429 Wastewater Force Mains

III.4.2.2. NOTE: The list of hardwood trees include the following, at a minimum:

Acer Spp.	Liriodendron Tulipifera	Prunus Spp.
Bald Cypress	Loblolly Bay	Pyrus Calleryana
Betula Nigra	Magnolia Family	Quercus Leavis
Blackgum	Magnolia Spp.	Quercus Spp.
Bradford Pear	Maple Family	Quercus Stellata
Cherry Family	Nyssa Sylvatica	Red Cedar
Cupressocyparis Leylandii	Oak Family	River Birch
East Palatka/Savannah Holly	Palm Family	Salix Babylonia
Gordonia Lasianthus	Palmacea Spp.	Sweetgum
Juniperus Silicicola	Pine Family	Sycamore
Ilex Attenuata	Pinus Spp.	Taxodium Distichum
Leyland Cypress	Platanus Occidentalis	Tulip Poplar
Liquidambar Styraciflue	Post Oak	Turkey Oak
		Weeping Willow

### III.5. SYSTEM CONNECTIONS

All connections and ties to the JEA Wastewater System and transfer of services will be performed by the contractor under supervision of the JEA's representative.

#### III.5.1. FORCE MAIN CONNECTION TO EXISTING MANHOLE

Where a new force main is connected into an existing manhole the manhole shall be properly prepared to receive the new force main and repaired or replaced as indicated or specified. Replacement manhole shall be Polymer Concrete. Manhole inverts shall be reshaped as required by the new connection to provide a smooth flowing channel of the exact shape of the wastewater to which it connects. Manholes shall receive a protective coating as specified in Chapter IV. 6. - Section 446 of these specifications. An approved gate valve or plug valve must be installed immediately prior to the 45° bends going into the manhole and shall be constructed in accordance with Detail S-18.

#### III.5.2. TAPPING SLEEVE AND VALVE CONNECTIONS

Unless approved otherwise by JEA, tapped connections in the barrel of a pipe shall be less than the diameter of pipe being tapped except 4 inch pipe which may be tapped with a 4 inch tapping sleeve and valve. No taps shall be made within 5 feet of a joint.

### IV. PRIVATE WASTEWATER PUMP STATION PIPING

If the wastewater force main is constructed per JEA standards (i.e.: 4" minimum pipe size, PVC DR- 18 Pipe, D.I. Fittings, Iron Valves, etc.) and if these utilities are dedicated and accepted by JEA, all piping within the City R/W will be O&M by JEA.

#### IV.1. ISOLATION GATE VALVE

A JEA approved gate valve (4" minimum) shall be provided at the R/W line (just outside the pump-out box) for all force main piping which exceeds 15 linear feet within the City R/W area. The gate valve at the R/W

# *JEA Water and Wastewater Standards*

## *429 Wastewater Force Mains*

line is not required on force main piping where the connection (connection at JEA main) is located on the same side of the street as the pump-out box (short side service connection) and consist of 15 linear feet or less within the City R/W area. The gate valve or, if no gate valve exist, the R/W line will define the "JEA Point of Service".

### **IV.2. PUMP OUT BOX**

A wastewater pump-out box shall be constructed on private property and located at the R/W line. The Pump-Out box shall provide a pump-out connection including a 4" isolation valve and 4" hose connection (quick disconnect with cap). The preferred construction layout is as shown on JEA plate #S-46. The box may be utilized by JEA or the private owner for maintenance or emergency use. JEA shall have access to the pump-out box at all times. O&M of this box (located on private property) shall be by the private owner.

### **IV.3. LOW PRESSURE STATION CONNECTIONS**

Low pressure wastewater station connections to a standard force main larger than 4 inches are not allowed. Connection must be either a gravity point or a force main designed and permitted for low pressure wastewater systems.

## **V. TESTING**

### **V.1. PRESSURE AND LEAKAGE TESTS**

The Contractor shall test pipelines installed in accordance with these specifications prior to acceptance of the pipeline by JEA or connecting pipeline to any existing pipeline or facility. All field tests shall be made in the presence of a JEA representative. Except as otherwise directed, all pipelines shall be tested. Pressure testing of PVC and stainless steel pipe shall not include HDPE main piping. Pressure testing of HDPE main piping shall be completed separately with no PVC or stainless steel pipe included in the HDPE test section. Testing of HDPE main piping is detailed in the specification section entitled, "Horizontal Directional Drilling", (Chapter VI. 2. - Section 750 and 755). Pipelines laid in excavation (other than trench excavation), shall be tested prior to the backfilling of the excavation. All piping to operate under liquid pressure shall be tested in sections of approved length. For these tests, the Contractor shall furnish clean water, suitable temporary testing plugs or caps, and other necessary equipment, and all labor required. If the Contractor chooses to pressure test against an existing JEA water main/valve, the new water main must be disinfected prior to connection to the JEA line. JEA will not be responsible for failure of the pressure test due to the existing valve leaking. If positive test results cannot be obtained because the JEA valves will not hold the test pressures, the Contractor shall be required to disconnect from the JEA System and re-test independent of the JEA System and at the Contractor's expense. JEA may elect to furnish suitable pressure gauges. If not, the contractor will provide the pressure gauges. The gauges shall be calibrated by an approved testing laboratory, with increments no greater than 2 psi and a 4 inch diameter face. Gauges used shall be of such size that pressures tested will not register less than 10% no more than 90% of the gauge capacity. Leakage and pressure testing shall be in accordance with applicable AWWA C600 or AWWA C605 and as outlined below.

#### **V.1.1. CLEANING & SWABBING**

The purpose of swabbing a new pipeline is to conserve water while thoroughly cleaning the pipeline of all foreign material, sand, gravel, construction debris and other items not found in a properly cleaned system. Prior to pressure testing of a new pipeline swabbing shall be utilized as specified on the construction plans for each project. Swabbing details, Chapter IX, Plates S-54, S-54A, S-54B, S-54C and S-54D.



# *JEA Water and Wastewater Standards*

## *429 Wastewater Force Mains*

- V.1.1.1. New water, wastewater force, and reclaim mains greater than 12" I.D. (with exceptions to smaller pipe lines as deemed necessary by JEA) shall be hydraulically cleaned with a polypropylene swabbing device to remove dirt, sand and debris from main.
- V.1.1.2. If swabbing access and egress points are not provided in the design drawings, it will be the responsibility of the CONTRACTOR to provide temporary access and egress points for the cleaning, as required.
- V.1.1.3. Passage of cleaning poly swabs through the system shall be constantly monitored, controlled and all poly swabs entered into the system shall be individually marked and identified so that the exiting of the poly swabs from the system can be confirmed.
- V.1.1.4. Cleaning of the system shall be done in conjunction with, and prior to, the initial filling of the system for its hydrostatic test.
- V.1.1.5. The CONTRACTOR shall insert flexible polyurethane foam swabs (two pounds per cubic foot density) complete with rear polyurethane drive seal, into the first section of pipe. The swabs shall remain there until the pipeline construction is completed. A JEA representative shall be present for the swabbing process including swab insertion and retrieval.
- V.1.1.6. The line to be cleaned shall only be connected to the existing distribution system at a single connection point.
- V.1.1.7. Locate and open all new in-line valves beyond the point of connection on the pipeline to be cleaned during the swabbing operation.
- v.1.1.8. At the receiver or exit point for the poly swab, the CONTRACTOR is responsible for creating a safe environment for collection of debris, water and the swab. Considerations shall be made for protecting surrounding personnel and property and safe retrieval of the swab.
- V.1.1.9. Only with JEA personnel on-site shall the supply valve from the existing distribution system be operated. Cleaning and flushing shall be accomplished by propelling the swab down the pipeline to the exit point with potable water. Flushing shall continue until the water is completely clear and swab(s) is/are retrieved.
- V.1.1.10. Re-apply a series of individual swabs in varying diameters and/or densities as required, to attain proper cleanliness of pipeline.
- V.1.1.11. Swabbing speed shall range between two and five feet per second.
- V.1.1.12. After the swabbing process, pressure testing and disinfection of the pipe shall be completed in accordance with this MANUAL.

### **V.1.2. HYDROSTATIC TESTING**

Hydrostatic testing shall consist of a combined pressure test and leakage test. Specified test pressures, based on the elevation of the highest point of the line or section under test, and corrected to the elevation of the test gauge, shall be applied by means of a pump connected to the pipe in a manner satisfactory to the Engineer. The pump, pipe connection and all necessary

# *JEA Water and Wastewater Standards*

## *429 Wastewater Force Mains*

apparatus shall be furnished by the Contractor and shall be subject to the approval of the Engineer. All valved sections shall be hydrostatic tested to insure sealing (leak allowance) of all line valves.

### V.1.2.1. Pipe Filling

Unless it has already been done, the section of pipe to be tested shall be filled with domestic water of approved quality and all air (or most of the air) shall be expelled from the pipe. Unlike water, entrapped air is compressible and is, therefore, very "explosive" and represents a very high risk of potential damage or even fatalities. Unless approved otherwise by JEA, the contractor shall be responsible for providing and paying for the domestic water utilized in filling the main and, if required, any flushing of the system. The table below is a convenient method to determine the approximate water addition that is required to raise the pressure in the test section from 0 psi to 150 psi with 0% air entrapment. Obviously, the test section will include some amount of air entrapment. The table below will indicate the severity of the amount of air entrapment in the test section. If the actual field test quantities (additional water amount) is over 4 times greater than the listed amounts, the test section may have severe air entrapment. In this case, the contractor should make additional effort to remove the entrapped air.

### V.1.2.2. Removal of Trapped Air

If blow offs or other outlets are not available at high points for releasing air, the Contractor shall make the necessary taps at such points and shall plug said holes after completion of the test. For mains larger than 20 inch size, it is highly recommended that the contractor profile (line and grade) the main after installation and prior to pressure and leakage test to accurately locate all high points. Field survey instrument (Level equipment) shall be utilized for this task. Blow off valves shall be installed at all high points which offset vertically more than two pipe diameters in length (at a minimum). The contractor shall consult the design engineer on any technical questions or concerns. The table below lists the approximate amount of water which must be added to the pipe to raise the line pressure from 0 psi to 150 psi when no air is present in the pipe.

Pipe Diameter (inch)	Gallons/1000 L.F.
6	0.73
8	1.31
10	2.04
12	2.94
14	4.00
16	5.22
18	6.61
20	8.16
24	11.75
30	18.36

# JEA Water and Wastewater Standards

## 429 Wastewater Force Mains

36	26.44
42	35.98

**V.1.2.3. Pressure Testing**

All piping shall be pressure and leakage tested for a minimum of two hours duration at 150 psi minimum or 2 times the operating pressure. Pressure tests shall be conducted simultaneously with the leakage test. During the 2 hour test, no pipe will be accepted if pressure loss is greater than 5 psi regardless of the leakage test results. All exposed pipe, fittings, valves and joints shall be examined carefully during the test.

**V.1.2.4. Repairs to Defective Pipe**

Any damaged or defective pipe, fittings or valves that are discovered following the pressure test shall be repaired or replaced with sound material and the test shall be repeated until it is satisfactory. For new installations, the contractor shall be limited to the number of repair couplings utilized to repair pipe joint leaks. Unless approved otherwise by JEA, the contractor is limited to two repair couplings (i.e., one joint leak) per 1,000 LF installed (same pipe size). Should the actual number of joint leaks exceed the above limit, then JEA may require the contractor to remove and re-install the entire associate main or certain sections of the main at the contractor's expense. Repairing, replacing and retesting shall be done at the Contractor's expense. For new work, "bell joint leak clamps" or similar devices are not acceptable for the repair of leaks at the joint.

**V.1.3. LEAKAGE TESTING**

Leakage tests shall be conducted simultaneously with the pressure tests. At the end of the pressure test, the line will be pumped back to initial test pressure. The quantity of water used to re-pump the line shall be measured and compared to the limitations calculated using the allowable leakage equations below.

**V.1.3.1.** Formula No. 1: shall be utilized to determine the allowable leakage amount for the test section constructed with PVC pipe (based upon the number of rubber gaskets). Pressure and Leakage Test form for the formula is provided in the back of Chapter III. 1. - Section 350.

$$\text{Formula No.1: (PVC only)} \quad L = (ND * P^{1/2}) / 7,400$$

$$P^{1/2} = 12.25, \text{ where } P = 150 \text{ psi}$$

- L = the allowable leakage amount in gallons per hour
- S = the length of pipeline tested, in feet (5,000 L.F. Max)
- D = the nominal diameter of the pipe, inches
- P = the average test pressure during the leakage test, in pounds per square inch
- N = equal to the number of joints (rubber gaskets) in the PVC pipe test section.

The total length of pipe within the test section shall not exceed 5,000 linear feet, unless approved otherwise by JEA.

**V.1.3.2. Repairs to Defective Pipe**

# *JEA Water and Wastewater Standards*

## *429 Wastewater Force Mains*

In the event a section fails to pass the tests, the Contractor shall do everything necessary to locate, uncover (even to the extent of uncovering the entire section), and replace the defective pipe, valve, fitting or joint. Visible leaks shall be corrected regardless of total leakage. Lines which fail to meet these tests shall be retested as necessary until test requirements are complied with. All testing shall be performed at the Contractor's expense.

### V.1.3.3. Alternative Procedures

If, in the judgment of JEA, it is impracticable to follow the foregoing procedures exactly for any reason, modifications in the procedure shall be made with approval; but, in any event, the Contractor shall be responsible for the ultimate tightness of the piping within the above requirement.

### V.1.3.4. HDPE Pipe

For leakage and pressure testing for high density polyethylene (HDPE, PE), Pipe and fittings, see "Horizontal Directional Drilling" (Chapter VI. 2. - Section 750 and 755), for technical specifications for testing HDPE products. Due to the expansion of HDPE pipe, the pressure testing of HDPE pipe sections must be tested separately from PVC pipe sections (see Chapter VI. 2. - Section 750 and 755 for clarification).

## VI. LOCATE WIRE

### VI.1. LOCATE WIRE INSTALLATION

Contractor shall furnish and install locate wires on all force mains (see Detail S-49 for other locate wire requirements).

VI.1.1. Locate wire must be attached to mains and services with duct tape or plastic ties at each side of bell joint or fitting and at 10 foot intervals along pipeline (at a minimum).

VI.1.2. Locate wire shall be brought to 4 foot above grade within a valve box or Locating Station box, as required, at 475 foot intervals (maximum).

VI.1.3. Locate wire shall not terminate in an air release valve (ARV) vault. ARV vaults may be corrosive environments for locate wire materials and the vaults are defined as confined spaces.

VI.1.4. Locate wire shall be installed in either the 1:00 or 11:00 position on the pipe.

VI.1.5. Connections and splices shall be made at grade within a Valve Box or a Locate Wire Box. Underground connections and splices are not allowed and shall be prohibited. If an underground connection is unavoidable, contact locates before proceeding. Once approved, the spliced tracer-wire joint shall be a waterproof connector, each connection shall be photographed showing a specific identification number (the station and off-set location) written on each waterproof connector.

### VI.2. LOCATE WIRE TESTING REQUIREMENTS

Each installed locate wire within the JEA service area shall be tested by the contractor as part of the final inspection procedure, using an approved tester and approved testing equipment.

#### VI.2.1. APPROVED TESTER

# *JEA Water and Wastewater Standards*

## *429 Wastewater Force Mains*

VI.2.1.1. A person approved by JEA as proficient in the use of the equipment and who has 12 months experience in the use of the equipment including documented proof of past performance.

VI.2.1.2. The approved tester shall be listed on the JEA Responsible Bidder List (RBL) for, at minimum, work category GC11 - Line locate services / Wire testing.

### **VI.2.2. CONTRACTOR REQUIREMENTS**

VI.2.2.1. The contractor shall prepare the following:

- A set of project site drawings showing the stationing and offset for each locate wire box.
- A locate wire field testing schedule.

VI.2.2.2. The contractor shall submit the project site drawings and the field testing schedule to the JEA field representative (inspector) for approval. The JEA field representative may elect to be present during the testing period.

VI.2.2.3. The contractor shall provide the approved tester a copy of the project site drawings showing the stationing and offset for each locate wire box.

VI.2.2.4. The approved tester shall place a tone on the locate wire and trace the entire length of the installed wire, spot painting the location at least at 200-foot intervals along the route.

VI.2.2.5. The approved tester shall test the wire depth at 200-foot intervals.

VI.2.2.6. The approved tester shall report (show on project site drawings), where the pipe/wire has less than the allowable minimum cover or more than the maximum allowable cover (see Pipe Cover Section above for pipe cover limits). For pipe/wire which are installed within the acceptable cover limits, no remarks are required. All lateral stub-outs shall be marked and recorded.

VI.2.2.7. The approved tester shall prepare a Locate Wire Box checklist for each locate wire box.

VI.2.2.8. The approved tester shall prepare a final Locate Wire Report. The Locate Wire Report shall be submitted to the JEA field representative for review and approval. The report shall include the following:

- A signed statement from the approved tester certifying that all installed wire (where shown on the project site drawings), was successfully (sounded), traced with no open breaks.
- A copy of the project site drawings which indicate all field notes, breaks found/repaired, depths (if installed outside the acceptable cover limits), and other applicable field remarks by the approved tester.
- Copies of the Locate Wire Box checklist for each locate wire box shown on the project site drawings.

VI.2.2.9. A final Locate Wire Report shall be furnished prior to final acceptance of the project or as approved otherwise by JEA.

# *JEA Water and Wastewater Standards*

## *429 Wastewater Force Mains*

### **VI.3. INSPECTION**

All pipe and fittings shall be subject to inspection at time of delivery and also in the field just prior to installation. All pipe and fittings which in the opinion of the Engineer do not conform to these specifications will be rejected and shall be removed by the Contractor at the Contractor's expense. An authorized JEA representative must be present for all pressure and leakage testing, connections to JEA's existing lines.

### **VI.4. PERMITTED CROSSINGS**

#### **VI.4.1. STATE HIGHWAY CROSSINGS**

Permits for all work within the right-of-way of a State Highway will be obtained by the Engineer. The Contractor shall, however, verify the existence of the permit before commencing work in this area. All work related to the State Highway crossing shall be in full compliance with the requirements of the Florida Department of Transportation permit and in accordance with the Florida Department of Transportation Utility Accommodation Guide and standard specifications. Unless otherwise shown on the drawings or specified herein, State Highway crossings shall be made by jacking a steel pipe casing, of the size shown on the drawings and shown in JEA Standard Details, under the highway at the elevations and locations shown. The force main shall then be placed in the casing with approved casing spacers as specified in this section. All joints within carrier pipe shall be mechanically restrained joints. After inspection, the ends of the casing shall be filled with 2500 psi concrete not less than 8-inches thick.

#### **VI.4.2. RAILROAD CROSSINGS**

Permits for all work within the railroad right-of-way will be obtained by the Engineer. The Contractor shall, however, verify existence of the permit before commencing work in this area. All work related to the railroad crossings shall be in full compliance with the terms of the permit and Area Specifications for Pipeline Crossings under Railway Tracks for Non- Flammable Substances. The force main shall be placed in steel casing pipe under all railroad crossings whether installed by open cutting or jacking and boring. The force main shall then be placed in the casing with approved casing spacers as specified in this section. All joints within carrier pipe shall be mechanically restrained joints. After inspection by the Engineer, the ends of the casing shall be sealed with 2,500 psi concrete not less than 12 inches thick. Upon completion and prior to final acceptance, the Contractor shall place crossing markers of a type acceptable to the Railroad Company at each end of the crossing at the railroad right-of-way.

### **VII. INSPECTION CHECKLISTS AND REPORTS**

# JEA Water and Wastewater Standards 429 Wastewater Force Mains

## VII.1. PRESSURE AND LEAKAGE TEST: HDPE PIPE

Project Name: \_\_\_\_\_

Test Section: \_\_\_\_\_

Availability Number: \_\_\_\_\_ Project Number: \_\_\_\_\_ Date/Time: \_\_\_\_\_

Date/Time Start: \_\_\_\_\_ Date/Time Finish: \_\_\_\_\_

STA/Offset Start: \_\_\_\_\_ STA/Offset Finish: \_\_\_\_\_

Other Test Phase Attendees:

_____	_____
_____	_____
_____	_____

Service:  Potable Water  
 Reclaimed Water  
 Wastewater

### Line Pressure Test:

Start: \_\_\_\_\_ PSI Minimum of 150 PSI or 2 x the operating pressure

End: \_\_\_\_\_ PSI

PSI Difference: \_\_\_\_\_ PSI If greater than 5 psi, the test fails

Line Pressure Test Results  Pass  Fail

### Line Leakage Test:

TYPE OF HDPE PIPE (DR RATING) (1)	DIAMETER OF PIPE (INCHES) (2)	LINEAR FEET (3)	2-HOUR TEST FACTOR (See Table Below *) (4)	TOTAL ALLOWABLE LEAKAGE (3x4) (5)
Total Allowable Leakage Amount (Gallons)				

# JEA Water and Wastewater Standards

## 429 Wastewater Force Mains

JEA 2-HOUR TEST FACTORS			
*NOMINAL PIPE SIZE (inches) – ALLOWABLE LEAKAGE AMOUNT (Gallons/Linear Feet of Pipe)			
4" – 0.0020	6" – 0.0030	8" – 0.0050	10" – 0.0065
18" – 0.0215	20" – 0.0275	22" – 0.0350	24" – 0.0440
32" – 0.0715	34" – 0.0810	36" – 0.0900	42" – 0.1155
4" – 0.0020	6" – 0.0030	8" – 0.0050	10" – 0.0065
18" – 0.0215	20" – 0.0275	22" – 0.0350	24" – 0.0440
32" – 0.0715	34" – 0.0810	36" – 0.0900	42" – 0.1155

Allowable Leakage Amount \_\_\_\_\_ GAL      \_\_\_\_\_ Oz. (32 oz per qt, 128 oz per gal)

Actual Leakage Amount \_\_\_\_\_ GAL      \_\_\_\_\_ Oz.

Line Leakage Test Results     Pass     Fail

The above is based on the average pressure test of 150 PSI, 2 hour test period. If the actual leakage amount is equal or less than the allowable leakage amount, the leakage test is acceptable.

Comments:

---



---



---

Contractor Representative:

---

*Signature & Printed Name*

JEA Inspector:

---

*Signature & Printed Name*

JEA O&M representative:

---

*Signature & Printed Name*



# JEA Water and Wastewater Standards 429 Wastewater Force Mains

## VII.2. PRESSURE AND LEAKAGE TEST: PVC PIPE

Project Name: \_\_\_\_\_

Test Section: \_\_\_\_\_

Availability Number: \_\_\_\_\_ Project Number: \_\_\_\_\_ Date/Time: \_\_\_\_\_

Date/Time Start: \_\_\_\_\_ Date/Time Finish: \_\_\_\_\_

STA / Offset Start: \_\_\_\_\_ STA / Offset Finish: \_\_\_\_\_

Other Test Phase Attendees:

- Service:  Potable Water  
 Reclaimed Water  
 Wastewater

### Line Pressure Test:

Start: \_\_\_\_\_ PSI Minimum of 150 PSI or 2 x the operating pressure

End: \_\_\_\_\_ PSI

PSI Difference: \_\_\_\_\_ PSI If greater than 5 psi, the test fails

Line Pressure Test Results  Pass  Fail

### Line Leakage Test:

TYPE OF PVC PIPE (1)	DIAMETER OF PIPE (INCHES) (2)	NUMBER OF JOINTS (3)	2-HOUR TEST FACTOR (4)	TOTAL ALLOWABLE LEAKAGE (2x3x4) (5)
PVC			0.00331	
PVC			0.00331	
PVC			0.00331	
PVC			0.00331	
PVC			0.00331	
			PVC (Sum of Above):	
			Total Allowable:	

Allowable Leakage Amount \_\_\_\_\_ GAL \_\_\_\_\_ Oz. (32 oz per qt, 128 oz per gal)

Actual Leakage Amount \_\_\_\_\_ GAL \_\_\_\_\_ Oz.

# JEA Water and Wastewater Standards

## 429 Wastewater Force Mains

Line Leakage Test Results:  Pass       Fail

The above is based on the average pressure test of 150 PSI, 2 hour test period and utilizing formula as given below ("L" is the allowable leakage amount in gallons per hour, "N" is the number of joints (rubber gaskets) in the test section; "D" is the diameter of the pipe and "P" is the average test pressure):

$$L = \frac{NDP}{7,400}$$

Formula may be used to determine an allowable leakage amount for PVC Pipe only. If the actual leakage amount is equal or less than the allowable leakage amount, the leakage test is acceptable (test passes). If the actual leakage amount is greater than the allowable leakage amount, the leakage test fails. The above formula meets and exceeds the requirements of AWWA C600 and AWWA C605. The total length of pipe within the test section shall not exceed 5,000 linear feet, unless approved otherwise by JEA.

Comments:

---

---

---

Contractor Representative:

---

*Signature & Printed Name*

JEA Inspector:

---

*Signature & Printed Name*

JEA O&M representative:

---

*Signature & Printed Name*

# JEA Water and Wastewater Standards 429 Wastewater Force Mains

## VII.3. TRACER WIRE CERTIFICATION FORM

Project Name: \_\_\_\_\_

Availability Number: \_\_\_\_\_ Project Number: \_\_\_\_\_ Date/Time: \_\_\_\_\_

Service:  Potable Water  
 Reclaimed Water  
 Wastewater

Continuity/Signal strength between access points:			Marker Balls Installed / Located (Check)			
Access pt #1 to access pt #2:			Installed		Located	
Access pt #2 to access pt #3:			Installed		Located	
Access pt #3 to access pt #4:			Installed		Located	
Access pt #4 to access pt #5:			Installed		Located	
Access pt #5 to access pt #6:			Installed		Located	
Access pt #6 to access pt #7:			Installed		Located	
Access pt #7 to access pt #8:			Installed		Located	
Access pt #8 to access pt #9:			Installed		Located	
Access pt #9 to access pt #10:			Installed		Located	

	Water	Sewer / FM	Reclaimed Water	Fiber Optic
Total footage tested				

If any faults found List below (please indicate utility type and location)	
Fault # 1:	
Fault # 2:	
Fault # 3:	
Fault # 4:	

Comments: \_\_\_\_\_

***JEA Water and Wastewater Standards  
429 Wastewater Force Mains***

Name of Tester:

\_\_\_\_\_  
*Signature & Printed Name*

Testing Company:

\_\_\_\_\_  
*Printed Name*

Contractor Representative:

\_\_\_\_\_  
*Signature & Printed Name*

Installation Contractor:

\_\_\_\_\_  
*Printed Name*

JEA Inspector:

\_\_\_\_\_  
*Signature & Printed Name*

JEA O&M representative:

\_\_\_\_\_  
*Signature & Printed Name*

Commissioned this date:

\_\_\_\_\_  
*Signature & Printed Name*

Locate Wire Test Results

Pass

Fail

*Blank Page*

## **430 - WASTEWATER VALVES AND APPURTENANCES**

### **I. GENERAL REQUIREMENTS**

#### **I.1. SCOPE OF WORK**

The contractor shall furnish, install, joint, and test all gate valves, check valves and other special valves and appurtenances as shown on the drawings and herein specified. In general, gate valves shall be utilized on wastewater force mains, except at the pump station site, where plug valves are required. The typical gate valve spacing shall be every 1,000 ft. maximum and upstream at branches of intersecting force mains. All references to Industry Standards (ASTM, ANSI, AWWA, etc.) shall be to the latest revision unless otherwise stated. Only those materials included in the JEA Water and Wastewater Standards Manual shall be installed. All materials shall be new unless specifically called for otherwise. The contractor shall field check all exposed bolts on all valves to insure that they are tight prior to installation. All manifold connections into a JEA force main system shall be 4" size, at a minimum.

#### **I.2. SHOP DRAWING SUBMITTALS**

Actual catalog data, brochures and descriptive literature will not be required for items of standard usage which meet the requirements of Chapter X. and Chapter XI. of the JEA Water and Wastewater Standards Manual. Any specialty item not shown in this manual will require a complete shop drawing submittal. The Engineer may at any time require the Contractor to provide a complete detailed shop drawing submittal for any material which may, in the Engineer's opinion, not be in compliance with the JEA Water and Wastewater Standards.

#### **I.3. ROTATION OF OPENING**

All valves shall open by turning to the left or counter clockwise, when viewed from the stem.

#### **I.4. EXTENSION STEMS**

Where extension stems are required, substantial, adjustable wall brackets and extension stems shall be furnished and located as directed. Extension stems shall be provided on all buried valves when the operating nut is deeper than 30 inches below the final grade. Sufficient stem extension shall be provided so that the nut will be no more than 30 inches below finished grade.

#### **I.5. PAINTING OF VALVES AND VALVE BOX LIDS**

The interior and exterior surfaces of all valves shall be epoxy coated, if not otherwise noted. The top side of all wastewater valve box covers and the inside of the top section of the valve box shall be painted green. Oil based, traffic-rated paint shall be used.

#### **I.6. HYDROSTATIC AND LEAKAGE TEST**

The Contractor shall be required to perform a separate hydrostatic/leakage field test on each valve installed to insure it is bubble tight. The duration of this test shall be 15 minutes at 150 psi and conform to AWWA C504. The method of performing this test shall be left up to Contractor with the Engineer's approval. The failure of the valve to perform will result in its removal from the job site and replacement by the Contractor at the contractor's expense.

#### **I.7. LOCATING MARKERS FOR VALVES & SERVICES**

# *JEA Water and Wastewater Standards*

## *430 Wastewater Valves and Appurtenances*

### **I.7.1. VALVE MARKERS**

- I.7.1.1. A 'V' cut shall be carved in the curb closest/adjacent to a below grade valve. This 'V' cut shall be painted green. See Wastewater Construction Details S-30.
- I.7.1.2. A green wastewater marker ball shall be installed on all buried valves. See Wastewater Construction Details S-30.

### **I.7.2. SERVICE MARKERS**

- I.7.2.1. Sewer services shall include an "S" cut in the curb painted green. See Wastewater Construction Details S-19.
- I.7.2.2. A green wastewater marker ball shall be installed on all sewer services at the property line. See Wastewater Construction Details S-19.

### **I.8. WARRANTY**

The Contractor shall supply to JEA a two (2) year unconditional warranty after substantial project completion or acceptance or any designated portion thereof. The warranty shall include materials and installation and shall constitute complete replacement and delivery to the site of materials and installation of same to replace defective materials or defective workmanship with new materials/workmanship conforming to the specifications.

### **I.9. INSPECTION CHECKLIST**

Contractor shall schedule a final walk through (prior to substantial completion) in order to create a punch list for each project. List of attendees shall include but not be limited to the Contractor's representative, JEA representative (i.e. project inspector), and designated JEA Operation personnel. Contractor shall be required to provide a crew complete with all necessary equipment to allow observation/operation of each new and rehabilitated air release valve, meter box and valve. The Contractor's representative shall complete the associated JEA Final Inspection Checklist for each new or rehabilitated air release valve, meter box and valve, and have the JEA attendees provide original signatures/names on the signature block. The JEA representative shall scan the checklists and ensure the documents are filed in the electronic file folder for the project.

## **II. GATE VALVES**

### **II.1. GENERAL**

Isolation gate valves shall be provided upstream at the branches of all intersecting force mains, at force main stub outs for future connections, on the force main in the right-of-way adjacent to the discharge manhole, and the typical gate valve spacing shall be every 1000 ft. maximum. Gate valves shall be designed for 250 psi minimum working pressure. When full open, gate valves shall have a clear waterway equal to the nominal diameter of the pipe. The operating nut or wheel shall have an arrow cast in the metal indicating the direction of opening. Each valve shall have the manufacturer's distinctive marking, pressure rating and year of manufacture cast on the body. Prior to shipment from the factory, each valve shall be tested by applying to it a hydraulic pressure equal to 500 psi (twice the specified working pressure).

### **II.2. BURIED VALVES**

Buried gate valves shall be iron body bronze mounted; all exterior mounted bolts and nuts shall be stainless steel, rubber or EDPM encapsulated, resilient seat, solid wedge, non-rising stem type; with operating nuts

# *JEA Water and Wastewater Standards*

## *430 Wastewater Valves and Appurtenances*

and adjustable valve boxes and covers. Operating nuts shall be two inches square. Resilient seat or wedge type gate valves shall conform to applicable sections of AWWA Standards C509 (250 psi) or C-515. Gate valves 24-inch and larger may be double disc type meeting AWWA C-500. All gates valves 24-inches or larger must be geared for vertical (spur) installations. All valves shall be installed vertically unless additional depth of bury is impossible due to physical obstructions. If a horizontal gate valve is required and approved by JEA, then the gate valve shall only be a double disc type (with rollers, scrapers and tracks) and be geared (bevel geared).

### **II.3. ABOVE GROUND VALVES**

Gate valves located above ground or inside structures shall be hand wheel operated, non-rising stem type with flanged ends and be of the same general construction as buried valves.

### **II.4. VALVE JOINTS**

All gate valves shall have mechanical joint ends, flanged ends, or screw joints to fit the pipe run in which they are used, except valves installed on push-on joint pipe shall have mechanical joint ends unless otherwise specified.

## **III. PLUG VALVES**

### **III.1. GENERAL**

All plug valves, unless specifically shown otherwise on the drawings, shall be of non-lubricated, eccentric plug type with Buna "N" neoprene, epoxy or fusion bonded, nylon faced plugs. Valve bodies shall be ASTM A126, Class B cast iron with all exterior mounted bolts and nuts to be stainless steel. Port areas of 4 inch through 20 inch valves shall be at least 80% full pipe area and 24 inch and larger valves shall be at least 70% full pipe area. The valve seat material shall consist of either a welded in 1/8 inch overlay of 90% pure nickel, or 316 stainless steel screwed into the cast iron body. Upper and lower plug stem bearings shall be sleeve-type of a stainless steel or other non-corrosive bearing material. The packing shall be adjustable and the bonnet shall be bolted. All bolts, nuts and washers shall be 316 stainless steel for buried, non-buried, and pit installed service. All buried valves on push-on joint pipe shall have mechanical joint ends and meet the requirements of ANSI A21.11. All exposed (non-buried) valves shall have flanged ends in accordance with American Standard B16.1, Class 125. The valves shall be rated for a minimum of 150 psi, non-shock cold W.O.G. and shall provide drip-tight shut off with this pressure in either direction. The operating nut or hand wheel shall have an arrow cast in the metal indicating direction of opening. The valve manufacturer shall furnish certified copies of performance, leakage and hydrostatic testing as outlined in AWWA C504. The interior of all plug valves shall be epoxy coated.

### **III.2. OPERATORS/ACTUATORS**

All plug valves 8 inches and larger shall be equipped with totally enclosed worm gear actuators complying with AWWA C504. All gearing shall run in oil. The actuator housing shall be semi-steel with seals to prevent dirt or water from entering the housing. Shaft bearings shall be permanently lubricated bronze bushings. Appropriately sized hand wheel operators shall be provided for each non-buried, gear-actuated valve.

### **III.3. BURIED VALVES**

Buried valves shall have seals on all shafts and gaskets on the valve covers. Buried valves shall be provided with 2-inch square operating nuts.

### **III.4. VALVE JOINTS**



# *JEA Water and Wastewater Standards*

## *430 Wastewater Valves and Appurtenances*

All plug valves shall have mechanical joint ends if buried on push-on joint pipe or flanged ends if above ground on flanged pipe.

#### **IV. CHECK VALVES**

Check valves shall conform to the requirements of AWWA C508. Check valves larger than 2-inch nominal size shall be iron body with stainless steel bolts and nuts, flanged ends, 316 stainless steel shaft connected to a steel outside lever and weight, swing-type with straight-away passageway of full pipe area. The valve shall have renewable bronze seat ring and rubber-faced disc. Check valves larger than 2 inches shall be 150 psi working pressure. Check valves 2 inches and smaller nominal size shall be all brass swing check valves, 200 psi working pressure.

#### **V. MISCELLANEOUS VALVES AND APPURTENANCES**

##### **V.1. TAPPING SLEEVES AND SADDLES**

To be utilized only for live tap applications or where specifically approved by JEA. No taps (all sizes) shall be made within 5 pipe diameters or 5 feet (whichever is smaller) of a joint. Unless approved otherwise by JEA, size-on-size taps are limited on PVC mains to 12-inch size and smaller. Size-on-size taps are acceptable on D.I.P. (all sizes). For size-on-size taps, on 8" and larger mains, the actual tap hole size shall be reduced by 1-inch.

##### **V.1.1. STAINLESS STEEL TAPPING SLEEVE**

Stainless steel tapping sleeves may be used on 4-inch pipe and larger. Stainless steel tapping sleeves shall be all 304 stainless steel, including flanges, bolts and nuts and shall be rated for 150 psi minimum operating pressure and 200 psi minimum test pressure. The tapping sleeve shall have a pilot flange recessed for tapping per MSS SP-60. The pilot flange shall be pressure rated Class D according to AWWA C207 with 125-pound drilling conforming to ANSI B16. Each sleeve shall be supplied with a flanged gasket bonded to the flange. The body gasket shall be a full circle, grid pattern, converting the entire length of the sleeve, cloth reinforced with attached stainless steel bridge to support the gasket at the lugs. The gasket shall be made of SBR rubber or similar material, compounded for use with water, salt solution, mild acids, bases and sewage. The sleeve shall have a 3/4 inch NPT bronze or stainless steel test plug. All welds shall conform to ASTM A380 and shall be fully passivated. Tapping sleeves 8-inch and smaller may have outlet connection to fit a mechanical joint tapping valve.

##### **V.1.2. TAPPING SADDLE (2-INCH AND SMALLER OUTLET)**

Stainless steel (316) service saddles shall include 316 stainless steel double bands. Outlet sizes shall be 1-inch through 2-inches and have iron pipe threads (IPS). The outside diameter range of the saddle shall be properly sized to conform to the type of pipe being tapped without placing undue stress on the pipe. Pipe shavings or cuttings, including coupon, shall not enter the host pipe during the tapping operation. The hole cut in the host pipe shall be 1/16 inch diameter smaller than the outside diameter of the saddle outlet.

##### **V.1.3. TAPPING SADDLE (GREATER THAN 2-INCH OUTLET)**

Saddles which require an outlet larger than 2-inch size shall utilize a "tapping sleeve" with a flanged outlet, as specified above.

##### **V.2. TAPPING VALVE**

# *JEA Water and Wastewater Standards*

## *430 Wastewater Valves and Appurtenances*

### **V.2.1. GENERAL**

Tapping valves shall be iron body with stainless steel bolts and nuts, bronze mounted gate valves, non-rising stem, open left, resilient seat, and 2-inch square operating nut. Valves 24-inch and larger may be double disc type meeting AWWA C-500. All gate valves 24-inches or larger must be geared for vertical (spur) installations. All valves shall be installed vertically unless additional depth of bury is impossible due to physical obstructions. If a horizontal gate valve is required and approved by JEA, then the gate valve shall only be a double disc type (with roller, scrapers and tracks) and be geared (bevel geared). The valve ends shall be mechanical joint for use with ductile iron pipe on one side and standard flanged (Class 125) on the other. Tapping valves 8-inch size and smaller may be MJ by MJ valve ends to match sleeve (standard MJ gate valve). Valves shall conform to the applicable section of these specifications.

### **V.2.2. HYDROSTATIC AND LEAKAGE TEST**

After installing a tapping sleeve and valve, and prior to tapping of a pressurized water main, a hydrostatic and leakage test shall be performed. The test will be conducted by introducing water into a tap or test hole located at the neck of the outlet half of the sleeve, on sleeves furnished with said tap, and with the tapping valve in the closed position. Sleeves shall be provided with a test plug. The sleeve and valve shall be capable of maintaining a test pressure of 150 psi for 15 minutes duration, with no sign of visible leaks. All leaks shall be repaired by removing and replacing defective items with items free of defects, after which the sleeve and valve shall be re-tested. Such repair and re-testing shall be done until the installation passes the specified test. The Contractor shall furnish and install any necessary temporary restraints, gauges, pumps and other incidental and appurtenant items necessary to complete this work, and shall remove same upon completion of the test. A watertight plug (bronze or stainless steel), shall then be inserted into the test hole.

## **V.3. COMBINATION AIR VALVES**

### **V.3.1. MATERIALS**

V.3.1.1. The ARV body material shall be 316 Stainless Steel (316 SS).

V.3.1.2. Top assemblies, covers, or external parts that attach to the outside of the ARV body shall be: 316 SS, polypropylene, polyoxymethylene (POM), polyethylene, or acrylonitrile butadiene styrene.

V.3.1.3. ARV float material shall be 316 SS, polyethylene, polypropylene, POM, polyurethane, high-density polyurethane (HDPE), or ethylene propylene diene monomer rubber (EPDM).

### **V.3.2. OPERATIONAL REQUIREMENTS**

V.3.2.1. ARV shall have large air / vacuum port to allow large volumes of air to be exhausted during pipeline filling and to re-enter the pipeline during draining.

V.3.2.2. ARV shall have a smaller air release orifice to vent the pipeline under normal operating conditions.

V.3.2.3. ARV shall be capable of a zero-leakage seal at less than 3 psig.

V.3.2.4. ARV shall have a maximum operating pressure of at least 150 psig.

# *JEA Water and Wastewater Standards*

## *430 Wastewater Valves and Appurtenances*

V.3.2.5. ARV's 4" to 6" shall be equipped with surge protection as furnished by approved ARV manufacturers.

V.3.2.6. ARV shall be equipped with backwash appurtenances on the body as furnished by approved ARV manufacturers.

### V.3.3. ARV MARKINGS

Mark valves per Section 6.1 of ANSI/AWWA C512 and include:

- Manufacturer
- Model
- Inlet Diameter
- Large Air/Vacuum Port Diameter
- Small Air Release Orifice Diameter
- Maximum working pressure rating
- Minimum Sealing Pressure
- Serial Number
- JEA Asset ID

### V.3.4. CONNECTION HEIGHT AND TYPE

Connection shall be female National Pipe Thread (FNPT) for 2-inch diameter inlets and flanged for 3-inch diameter and larger with maximum total ARV height as specified below:

Inlet Size (in)	Connection	Maximum Height (in)
2	NPT	22.0
3	Flanged	25.6
4	Flanged	34.5
5	Flanged	40.0

### V.3.5. MANUFACTURER WARRANTY

The Manufacturer shall supply to JEA a ten (10) year unconditional warranty. The warranty shall include replacement, delivery and installation.

## V.4. BALL VALVES

Ball valves shall be 316 stainless steel, including the handle, rated at 1,000 psi WOG (minimum), threaded or flanged connections and TFI seats and seals.

## VI. VALVE BOXES

### VI.1. CONCRETE COLLAR

The Contractor shall furnish, assemble and install a valve box for each buried valve. Each valve box installed in un-paved areas shall be installed with a 24-inch round or square, 6-inch thick concrete collar with #4 reinforcing rebar rings, poured around the top of the valve box cover. The concrete shall have a

# *JEA Water and Wastewater Standards*

## *430 Wastewater Valves and Appurtenances*

minimum strength of 3000 psi. In lieu of a poured concrete collar, a pre-cast concrete valve pad may be utilized which meets the requirements below.

### **VI.2. PRECAST CONCRETE VALVE COLLAR**

- VI.2.1. Concrete rated at 4,000 psi (minimum). Fiber mesh re-enforcement is optional. Concrete shall be smooth and in one piece, with no cracks.
- VI.2.2. Pad must include two #2 (minimum) steel rebar rings for structural support.
- VI.2.3. Concrete thickness shall be 4 inches at the center and tapered to 2 inches at the outside edges.
- VI.2.4. The dimensions shall be 23-1/2 inches OD (minimum) with a 10-inch OD-centered hole.
- VI.2.5. This installation shall include applying grout in the annular space between the OD of the valve box and concrete pad. For support and adhesion, the grout shall be placed in the entire 4 inch vertical annular area within the pad open-hole space. The concrete pad must be placed on firm compacted sand. The top of the concrete pad shall be level with the top of the cast iron valve box and level with grade. The required brass valve identification tag shall be attached to the inside of the cast iron valve cover.

### **VI.3. VALVE TAGS**

Provide brass identification tag with "WASTEWATER", valve size, valve type and direction and number of turns to open. Provide a ¼ inch hole in brass tag and attach the tag to the end of the locate wire (twist wire around tag). Tag shall be 3-inch diameter and ¼ inch thick brass with ¼ inch hole. See Section 429, III.10.1. Locate Wire and Detail S-49 for more information.

### **VI.4. VALVE BOXES**

Adjustable valve boxes of suitable length shall be used. Cover shall be marked "WASTEWATER". The top section shall be adjustable for elevation and shall be set to allow equal movement above and below finished grade. The base shall be centered over the valve and shall be on line with nut at top of valve stem and the entire assembly shall be plumb. Boxes shall be cast iron. Cast iron castings shall be manufactured of clean, even grain, gray cast iron conforming to ASTM Designation A48, Class 20B, Gray Iron Castings; and shall be smooth, true to pattern, free from blow holes, sand holes, projections, or other harmful defects and shall be coated with a single thin coat of coal tar epoxy. The cover will not rock after it has been seated in any position in its associated jacket.

### **VII. METER BOXES (SERVICE ACCESS POINTS)**

Polymer Concrete meter boxes shall be manufactured using fiberglass reinforced materials and polymer concrete. The body of the box shall be manufactured using fiberglass reinforced materials, comprised from polyester resins and fiberglass matting. The top color of the box shall be manufactured from poured polymer concrete and shall be off-white color to match cover. The top (cover) shall be manufactured using polymer concrete (off-white color). The size of the meter box and load rating shall be as specified on the drawings, one inch meter box size (at a minimum). To obtain approval by JEA, the load ratings shall be certified by a professional engineer or state certified testing lab. The lid shall also be certified by Cellnet Technology and Sensus Metering Systems to be "RF" compatible with the Sensus MTU.

### **VIII. DUCTILE IRON BODY INSERT VALVE**

# *JEA Water and Wastewater Standards*

## *430 Wastewater Valves and Appurtenances*

The ductile iron 250 psig. rated insert valve shall be a resilient wedge gate valve designed for use in potable water, raw water, reclaimed water, sewage, irrigation and backflow control systems. The design will allow the valve to be installed into an existing pressurized pipeline while maintaining constant pressure and service.

### **VIII.1. DUCTILE IRON BODY**

- VIII.1.1. The ductile iron body, bonnet and wedge shall meet or exceed the requirements of AWWA C515 with 250 psig maximum working pressure. The pressure rating markings must be cast into the body of the insert valve. The insert valve shall be ductile iron construction meeting ASTM A536 Grade 65-45-12.
- VIII.1.2. Valve bodies sized 12" and smaller shall be capable of installation on cast/grey iron or ductile iron Class A B C and D, IPS PVC, C900 and C909 PVC, Steel, AC pipe diameters without changing either top or bottom portion of split valve body.
- VIII.1.3. Bolting materials shall develop the physical strength requirements of ASTM A307 with dimensions conforming to ANSI B18.2.1.

### **VIII.2. RESILIENT WEDGE GATE ASSEMBLY**

- VIII.2.1. The construction of the resilient wedge shall comply with AWWA C509.
- VIII.2.2. The ductile iron wedge shall be fully encapsulated with EPDM rubber by a high pressure and high temperature compression or injection mold process.
- VIII.2.3. The resilient wedge shall seat on the valve body and not the carrier pipe to obtain the optimum seating and flow control results. The resilient wedge shall be totally independent of the carrier pipe.
- VIII.2.4. The resilient wedge shall not come into contact with the carrier pipe or depend on the carrier pipe to create a seal.
- VIII.2.5. Pressure equalization on the down or upstream side of the closed wedge shall not be necessary to open the valve.
- VIII.2.6. The wedge shall be symmetrical and seal equally with flow in either direction.
- VIII.2.7. The resilient wedge must ride inside the body channels to maintain wedge alignment throughout its travel to achieve maximum fluid control regardless of high or low flow pressure or velocity. The resilient wedge must have more support than the operating stem as the resilient wedge enters and exits the water (fluid) way

### **VIII.3. FUSION BOND EPOXY COATING**

- VIII.3.1. The insert valve shall be shop epoxy coated on the interior and the exterior. The fusion-bonded coating shall be applied prior to assembly so that all casting surfaces, including the bolt holes and body-to-bonnet flange surfaces are fully epoxy coated.
- VIII.3.2. Valve shall be coated with a minimum of 8 mils fusion bond epoxy in compliance with AWWA C550 and certified to ANSI/NSF-61.

#### **VIII.4. GASKETS AND O-RING STEM SEALS**

- VIII.4.1. The inset valve shall have o-ring stem seals. Two o-rings shall be located above, and one o-ring shall be located below the thrust collar. The lower two o-rings shall provide a permanently sealed lubrication chamber. The upper o-ring shall protect the lower o-rings.
- VIII.4.2. Side flange seals shall be of the o-ring type of either round, oval, or rectangular cross-sectional shape.

#### **VIII.5. VALVE STEM AND THRUST WASHERS**

- VIII.5.1. The NRS stem must have an integral thrust collar in accordance with Section 4.4.5.3 of AWWA C515 Standard. Two-piece stem collars are not acceptable. The wedge nut shall be independent of the wedge and held in place on three sides by the wedge to prevent possible misalignment. The gate valve stem and wedge nut shall be a copper alloy in compliance with AWWA Standard 515, Section 4.4.5.1.
- VIII.5.2. Two thrust washers are used. One is located above, and one is located below the stem thrust collar.
- VIII.5.3. The valve shall be operated by 2" square wrench nut according to ASTM A126 CL.B – open left (counter-clockwise).

#### **VIII.6. SPLIT JOINT RESTRAINT**

- VIII.6.1. Shall consist of multiple gripping wedges incorporated into a follower gland meeting the applicable requirements of ANSI/AWWA C110/A21.10.
- VIII.6.2. The devices shall have a working pressure rating of 350 psi for 4-12 inch. Ratings are for water pressure and must include a minimum safety factor of 2 to 1 in all sizes.
- VIII.6.3. Gland body, wedges and wedge actuating components shall be cast from grade 65-45-12 ductile iron material in accordance with ASTM A536.
- VIII.6.4. The mechanical joint restraint shall retain full mechanical joint deflection during assembly as well as allowing joint deflection after assembly.
- VIII.6.5. Proper actuation of the gripping wedges shall be ensured with torque limiting twist off nuts. Pressure point set screw type hardware shall not be used.
- VIII.6.6. Restraint devices shall be listed by Underwriters Laboratories and approved by Factory Mutual (3" through 12" inch size).

#### **VIII.7. PRESSURE TESTING**

After the installation of the insert valve body on to the existing pipe a pressure test of 150 P.S.I.G. shall sustained for 15 minutes. Once the pressure test is affectively achieved the insert valve body shall not be moved as per AWWA Standards. If the insert valve is moved the pressure test must be completed again. The insert valve must not be moved or repositioned once the pressure test is satisfactorily completed and approved by the Owner/ Engineer

IX. INSPECTION CHECK LISTS AND REPORTS

# JEA Water and Wastewater Standards

## 430 Wastewater Valves and Appurtenances

### IX.1. VALVE INSPECTION CHECKLIST

Project Name: \_\_\_\_\_

Street/Intersection/Address Location: \_\_\_\_\_

Availability Number: \_\_\_\_\_ Project Number: \_\_\_\_\_ Valve Number: \_\_\_\_\_

Date/Time: \_\_\_\_\_

STA: \_\_\_\_\_

Offset: \_\_\_\_\_

Valve Size: \_\_\_\_\_

Valve Type: \_\_\_\_\_

Valve Depth to Nut (inches): \_\_\_\_\_

Number of Turns to open (count): \_\_\_\_\_

Valve use:  Mainline  Independent  Stub  Fire line

Service:	<input type="checkbox"/>	Potable Water
	<input type="checkbox"/>	Reclaimed Water
	<input type="checkbox"/>	Wastewater
Location:	<input type="checkbox"/>	Paved Area
	<input type="checkbox"/>	Grassed Area
Pad:	<input type="checkbox"/>	Concrete
	<input type="checkbox"/>	Asphalt
	<input type="checkbox"/>	N/A
Cover at Finished Grade:	<input type="checkbox"/>	Yes
	<input type="checkbox"/>	No - adjust per spec
Color Coded Cover per spec:	<input type="checkbox"/>	Yes
	<input type="checkbox"/>	No - provide color coded cover
Brass Tag Affixed:	<input type="checkbox"/>	Yes
	<input type="checkbox"/>	No
If No, is this a fire hydrant branch line?:	<input type="checkbox"/>	Yes
	<input type="checkbox"/>	No - provide brass tag per spec
Valve nut accessible:	<input type="checkbox"/>	Yes
	<input type="checkbox"/>	No - adjust per detail
Extension Provided (> 30 inches depth to nut)	<input type="checkbox"/>	Yes
	<input type="checkbox"/>	No--provide extension per spec.
Open Direction	<input type="checkbox"/>	Left
	<input type="checkbox"/>	Right - replace per spec



# JEA Water and Wastewater Standards

## 430 Wastewater Valves and Appurtenances

Valve exercised (Start closed then open fully):	<input type="checkbox"/>	Yes
	<input type="checkbox"/>	No
Valve position (after exercised):	<input type="checkbox"/>	Open (mainline / independent / fire)
	<input type="checkbox"/>	Partially closed (Stub)
Locate wire accessible in jacket	<input type="checkbox"/>	Yes
	<input type="checkbox"/>	No
Locate wire color coded	<input type="checkbox"/>	Yes
	<input type="checkbox"/>	No

Comments: \_\_\_\_\_  
\_\_\_\_\_  
\_\_\_\_\_

Contractor Representative: \_\_\_\_\_  
Signature & Printed Name

JEA Inspector: \_\_\_\_\_  
Signature & Printed Name

JEA O&M representative: \_\_\_\_\_  
Signature & Printed Name

Commissioned Date: \_\_\_\_\_

# JEA Water and Wastewater Standards 430 Wastewater Valves and Appurtenances

## IX.2. AIR RELEASE VALVE INSPECTION CHECKLIST

Project Name: \_\_\_\_\_

Street/Intersection/Address Location: \_\_\_\_\_

Availability Number: \_\_\_\_\_ Project Number: \_\_\_\_\_ ARV Number: \_\_\_\_\_

Date/Time: \_\_\_\_\_

STA: \_\_\_\_\_

Offset: \_\_\_\_\_

ARV Size (Inch): \_\_\_\_\_

Service:	<input type="checkbox"/>	Potable Water
	<input type="checkbox"/>	Reclaimed Water
	<input type="checkbox"/>	Wastewater
Connection:	<input type="checkbox"/>	Offset connection
	<input type="checkbox"/>	Direct connection (i.e. vault over main)
Vault Cover elevation:	<input type="checkbox"/>	Finish Grade
	<input type="checkbox"/>	Below/above finish grade – adjust per spec
Vault box interior lined:	<input type="checkbox"/>	Yes
	<input type="checkbox"/>	No – line per spec
	<input type="checkbox"/>	Not applicable – water, reclaimed or chilled main
Clearance - bottom of vault cover and top of ARV	<input type="checkbox"/>	8 inches or greater
	<input type="checkbox"/>	Less than 8 inches – adjust per detail
Valve position:	<input type="checkbox"/>	Open
	<input type="checkbox"/>	Closed
Stainless Steel Ball Valves	<input type="checkbox"/>	Yes
	<input type="checkbox"/>	No - replace per spec
Stainless steel piping or fittings	<input type="checkbox"/>	Yes
	<input type="checkbox"/>	No - replace per spec
Locate wire accessible in box	<input type="checkbox"/>	Yes
	<input type="checkbox"/>	No
Locate wire color coded	<input type="checkbox"/>	Yes
	<input type="checkbox"/>	No

Comments:

\_\_\_\_\_

\_\_\_\_\_

*JEA Water and Wastewater Standards  
430 Wastewater Valves and Appurtenances*

Contractor Representative:

\_\_\_\_\_  
\_\_\_\_\_  
Signature & Printed Name

JEA Inspector:

\_\_\_\_\_  
\_\_\_\_\_  
Signature & Printed Name

JEA O&M representative:

\_\_\_\_\_  
\_\_\_\_\_  
Signature & Printed Name

Commissioned Date:

\_\_\_\_\_

# JEA Water and Wastewater Standards 430 Wastewater Valves and Appurtenances

## IX.3. LOCATE WIRE BOX INSPECTION CHECKLIST

Project Name: \_\_\_\_\_

Street/Intersection/Address Location: \_\_\_\_\_

Availability Number: \_\_\_\_\_ Project Number: \_\_\_\_\_ Date/Time: \_\_\_\_\_

STA: \_\_\_\_\_ Offset: \_\_\_\_\_

Service:	<input type="checkbox"/>	Potable Water
	<input type="checkbox"/>	Reclaimed Water
	<input type="checkbox"/>	Wastewater
Curb Stamp w/Color Coding:	<input type="checkbox"/>	Yes
	<input type="checkbox"/>	No - Fix
Cover at Finished Grade	<input type="checkbox"/>	Cover above finish grade--adjust per spec.
	<input type="checkbox"/>	Cover below finish grade--adjust per spec.
Frame condition:	<input type="checkbox"/>	Good
	<input type="checkbox"/>	Cracked/broken - provide replacement
	<input type="checkbox"/>	Offset - needs resetting/re-grouting
Locate wire accessible in box:	<input type="checkbox"/>	Yes
	<input type="checkbox"/>	No, full of debris - excavate debris
Locate wire properly color coded:	<input type="checkbox"/>	Yes
	<input type="checkbox"/>	No--replace per spec
Locate wire signal verified:	<input type="checkbox"/>	Yes
	<input type="checkbox"/>	No, lined, fiberglass or polymer concrete
	<input type="checkbox"/>	No--repair per spec

Comments: \_\_\_\_\_

Contractor Representative: \_\_\_\_\_  
Signature & Printed Name

JEA Inspector: \_\_\_\_\_  
Signature & Printed Name

JEA O&M representative: \_\_\_\_\_  
Signature & Printed Name

Commissioned this date: \_\_\_\_\_  
Signature & Printed Name

# JEA Water and Wastewater Standards 430 Wastewater Valves and Appurtenances

## IX.5. TRACER WIRE CERTIFICATION FORM

Project Name: \_\_\_\_\_

Availability Number: \_\_\_\_\_ Project Number: \_\_\_\_\_ Date/Time: \_\_\_\_\_

Service:  Potable Water  
 Reclaimed Water  
 Wastewater

Continuity/Signal strength between access points:			Marker Balls Installed / Located (Check)			
Access pt #1 to access pt #2:			Installed		Located	
Access pt #2 to access pt #3:			Installed		Located	
Access pt #3 to access pt #4:			Installed		Located	
Access pt #4 to access pt #5:			Installed		Located	
Access pt #5 to access pt #6:			Installed		Located	
Access pt #6 to access pt #7:			Installed		Located	
Access pt #7 to access pt #8:			Installed		Located	
Access pt #8 to access pt #9:			Installed		Located	
Access pt #9 to access pt #10:			Installed		Located	

	Water	Sewer / FM	Reclaimed Water	Fiber Optic
Total footage tested				

If any faults found List below (please indicate utility type and location)	
Fault # 1:	
Fault # 2:	
Fault # 3:	
Fault # 4:	

Comments: \_\_\_\_\_

*JEA Water and Wastewater Standards  
430 Wastewater Valves and Appurtenances*

Name of Tester: \_\_\_\_\_  
Signature & Printed Name

Testing Company: \_\_\_\_\_  
Printed Name

Contractor Representative: \_\_\_\_\_  
Signature & Printed Name

Installation Contractor: \_\_\_\_\_  
Printed Name

JEA Inspector: \_\_\_\_\_  
Signature & Printed Name

JEA O&M representative: \_\_\_\_\_  
Signature & Printed Name

Commissioned this date: \_\_\_\_\_  
Signature & Printed Name

Locate Wire Test Results     Pass     Fail

*Blank Page*

## **433 - SUBMERSIBLE WASTEWATER PUMPING STATIONS**

### **I. GENERAL REQUIREMENTS**

#### **I.1. SCOPE OF WORK**

All Pump Stations in JEA's service area shall conform to section 433. The Contractor shall furnish, install, test and place in operation the submersible pumping station shown on the drawings and specified hereinafter. All applicable sections of the City of Jacksonville Standard Specifications and JEA Water and Wastewater Standards shall be considered part of this work. All references to Industry Standards (ASTM, ANSI, etc.) shall be to the latest revision unless otherwise stated. Only those materials included in the JEA Water and Wastewater Standards Manual, (including, but not limited to, submersible pumps, VFD equipment and control panels), shall be installed. All materials shall be new unless specifically called for otherwise. All structures, pumps and panels shall require a complete shop drawing submittal, as detailed in this specification for JEA's review and approval prior to the start of construction.

#### **I.2. PROJECT SCHEDULE AND COOPERATION**

The project schedule shall be established based on working a normal work schedule including five days per week, single shift, and eight hours per day or four days per week, single shift, ten hours per day. Unless approved otherwise by JEA, normal or general items of work such as setting wet well (base and riser sections), field pump test, density testing and final inspections, shall be scheduled during the normal work schedule. Due to operational and man power limitations on the JEA systems, JEA will require the contractor to perform work outside of the normal work schedule. These operational and manpower limitations, including but not limited to, tie-in work (cut-in work or other work) and other phases of the work which may impact the continued (non-interruptible) service to existing JEA customers. The contractor shall plan and anticipate the cost impact of these systems limitations and provide such work or services at no additional cost to JEA. Unless approved otherwise, a JEA representative shall be present to observe the excavated area prior to setting (installing) the wet well. The date and time for setting (installing), the pre-cast wet well shall be reviewed and approved by JEA, prior to the actual work.

#### **I.3. SHOP DRAWING SUBMITTALS**

Actual catalog data, brochures and descriptive literature will not be required for items of standard usage which meet the requirements of Chapter X. and Chapter XI. of the JEA Water and Wastewater Standards Manual. Any specialty item not shown in this manual will require a complete shop drawing submittal. The Engineer may at any time require the Contractor to provide a complete detailed shop drawing submittal for any material which, in the Engineer's opinion, may not be in compliance with the JEA Water and Wastewater Standards.

#### **I.4. AS-BUILT DRAWINGS**

As-built drawings shall be required on all Wastewater, force main and pump station projects, including projects for JEA, City of Jacksonville, JTA, DOT, private developments (utilities to be dedicated to JEA), and other City Authorities, etc. As-built drawings shall be in accordance with specification Chapter VI. 1. - Section 501, entitled "As-built Drawings" and as defined here-in. As-built drawings shall be reviewed and approved by JEA. The cost to provide as-built drawings shall be included as part of the related work requirements or general conditions for the utility work. The contractor shall submit preliminary "As-Built" drawings to JEA for JEA Project Manager, Development (if applicable) and O&M review prior to pump station pre start-up. JEA will review the preliminary pump station "As-Built" during the pre-start-up for accuracy. The preliminary "As-Built" drawing comments will be returned to the contractor following the pre



# ***JEA Water and Wastewater Standards***

## ***433 Submersible Wastewater Pumping Stations***

start-up. Once the "As-Built" is finalized and JEA has issued the as-built approval letter, the Certificate of Completion (COC) can be processed.

### **I.5. OPERATION AND MAINTENANCE DATA SUBMISSION**

All pump stations will be required to submit completed and approved equipment attribute worksheets, in JEA's submittal spreadsheet, prior to pump station acceptance. See Chapter IV.7. Pump Station Operation and Maintenance Data Submission Requirements - Section 445.

### **I.6. WARRANTY**

#### **I.6.1. CONTRACTOR WARRANTY**

The Contractor shall supply to JEA a two (2) year unconditional warranty effective on the date of the JEA's Operation and Maintenance Pump Station acceptance letter. The warranty shall include materials and installation and shall constitute complete replacement and delivery to the site of materials and installation of same to replace defective materials or defective workmanship with new materials/workmanship conforming to the specifications to insure safe and correct operation of the station.

#### **I.6.2. SPECIALTY WET WELL LINER MANUFACTURER WARRANTY**

The liner manufacturer shall warrant the liner against defects for at least ten (10) years after the date of acceptance by JEA. Defects are defined as cracking, delamination or leaking. The warranty shall require the manufacturer to supply all necessary labor, materials, and equipment to repair defects to satisfaction of JEA. The Contractor and/or manufacturer shall not make any exemption or exception to the above stated conditions or warranty.

#### **I.6.3. PUMP MANUFACTURER WARRANTY**

The Pump Manufacturer shall warrant to JEA all permanently installed municipal sewage service Submersible Pumps and Motors against all defects in materials and workmanship including normal wear and tear to the following parts for a period of 5 years: Mechanical Seals, Bearings, Shafts, Motor Electrical Cables and Motor Stators. See below for additional warranty and service requirements.

### **I.7. WORKMANSHIP**

All work shall be proved to be in first class condition and constructed in accordance with the drawings and specifications. All defects disclosed by tests and inspections shall be remedied immediately by the Contractor with no additional cost to JEA.

### **I.8. MATERIALS**

All material shall be free from defects impairing strength and durability and be of the best commercial quality for the purpose specified. Unless indicated otherwise on the drawings, all metal components in the wet well, with the exception of pipe, fittings, pumps and motors shall be 316 stainless steel as specified here in or on the plans. The pump supplier, to ensure unit compatibility shall supply the pumps, motors and guide rail system.

#### **I.8.1. STATION PIPING**

Station piping shall conform to JEA Water and Wastewater Standards Chapter IV. - Section 429, entitled Wastewater Force Mains and Chapter IV. 4. Section 430 entitled Wastewater Valves and

# *JEA Water and Wastewater Standards*

## *433 Submersible Wastewater Pumping Stations*

Appurtenances. Specifically, station piping shall be plumbed and aligned according the latest ASTM, AWWA standards, any piping irregularities shall be removed and replaced.

### I.8.1.1. Stainless Steel Piping and Fittings:

I.8.1.1.1. Piping within and external of the wet well shall be 316 stainless steel: flanged, schedule 40. Butt-welding of any piping (except for the emergency suction pipe in (the wet well) is not allowed. All bolts, washers and nuts shall be 316 stainless steel, threaded bolts and nuts shall be coated with "Never Seize" type coating.

I.8.1.1.2. Pipe outside of the wet well and above ground shall be 316 stainless steel, (schedule 40, one-piece construction all bolts, washers and nuts shall be 316 stainless steel, threaded bolts and nuts shall be coated with "Never Seize" type coating.

I.8.1.1.3. Fittings may be 316 stainless steel flanged type manufactured in accordance with ASTM-A774, AWWA C110 of the same raw material and in the same thicknesses as the pipe.

I.8.1.1.4. The finish on the stainless steel raw material, manufactured to ASTM A-240 will be No. 1, HRAP (hot rolled annealed and pickled) or better. The finish on the completed stainless steel pipe and fittings shall be as specified in ASTM A778 and A774, respectively.

### I.8.1.2. Ductile Iron Fittings:

Ductile iron fittings may also be flanged ductile iron with specialty inside coating.

### I.8.1.3. PVC Piping:

Buried piping shall be PVC DR 18. Transition from PVC to stainless steel or ductile iron shall be flange to mechanical joint.

### I.8.1.4. Cam-locks shall be 316 stainless steel.

## I.8.2. WET WELL SIZING

Minimum wet well size shall be 8-foot diameter. A 12-foot diameter wet well (minimum) shall be utilized in cases where the pump discharge piping (in the wet well) is 10-inch diameter or larger.

## I.9. SELECTION OF PUMP STATION TYPE & REQUIREMENTS

JEA Pump Station Standards are available in Auto CAD format, on the jea.com website. The selection of a pump station type shall comply with the following:

## *JEA Water and Wastewater Standards*

### *433 Submersible Wastewater Pumping Stations*

Pump Station Type	Pump Station Maximum Peak Flow	Pump Station Maximum (ADF & EDU)	Emergency Operating Requirement	Odor Control Requirements	Additional Design Requirements	Influent Solids Management System
Class I	0 – 440 GPM	174,999 GPD 499 EDU	Generator or Pump Engine*	Not required	Flow meter and Smart electric meter	Not required
Class II	441 – 1000 GPM	175,000 – 436,450 GPD 500 - 1247 EDU	Generator or Pump Engine	Piping and Wiring Required	Flow meter and Smart electric meter	Not Required
Class III	1001 – 2000 GPM	436,451 - 971,250 GPD 1,248 – 2,775 EDU	Generator and Emergency Pump Engine(s)**	Piping and Wiring Required	Flow meter and Smart electric meter, plus Electric power & controls building	Not Required
Class IV	2001 GPM and Above & Vacuum Stations	971,250 GPD and above 2,775 EDU and above	Generator and Emergency Pump Engine(s)**	Piping and Wiring Required	Flow meter and Smart electric meter, plus Electric power & controls building	Required

\* For exceptions for specific Class I Stations see 1.9.2. below.

\*\* See appendix for emergency backup requirements if emergency pump engine or generator is not feasible.

#### **I.9.1. DEFINITION OF FLOW**

I.9.1.1. The Pump Station Maximum Peak flow in GPM (gallons per minute) is the ultimate peak design flow of the pump station using the 10 State Standards peaking factor applied to 3.5 people per Equivalent Dwelling Units (EDU) and 100 GPD per person. The pump station Maximum Peak Flow GPM excludes the flow from the permanently installed stand-by pump and any emergency standby by pump.

I.9.1.2. The Pump Station Maximum Average Daily Flow (ADF) in GPD (gallons per day) is the station's un-peaked maximum/ultimate average daily flow rate the station will be pumping.

I.9.1.3. The Pump Station Maximum Equivalent Dwelling Units (EDU's) is the ultimate number of Equivalent Dwelling Units the station will be pumping, which equates to 350 GPD per EDU.

#### **I.9.2. BACK UP POWER REQUIREMENTS**

## *JEA Water and Wastewater Standards*

### *433 Submersible Wastewater Pumping Stations*

- I.9.2.1. An emergency operating system shall be required for all pump stations. The emergency operating system shall be a Generator Receptacle, an Emergency Generator (see section 472, Emergency Generator), Emergency Pump Engine(s) (see section 470, Emergency Pump Engine) and (if emergency pump engines are not feasible) Dual Feed electric service.
- I.9.2.2. For Class One pump stations with Low Flow up to 100 residential lots or 100 GPM (maximum peak flow) for commercial or multi-family developments, an emergency operation system may consist solely of a Generator Receptacle. While a generator or back up emergency pump is not required to be provided, space shall be provided on-site to accommodate a future permanent generator or emergency pump or a portable generator or emergency pump.
- I.9.2.3. For Class One pump stations that meet the following criteria, the station will require a generator receptacle and an alternative emergency operation system to consist of a generator or emergency pump engine.
- 101 lots or more;
  - Receive flow of 101 GPM or more for commercial projects;
  - Receive flow from one or more pump stations through a force main (re-pump);
  - Pump stations discharging through pipes 12-inches or larger.
- I.9.2.4. Refer to Chapter IV. 7. - Section 472, "Emergency Generator", for technical specifications on automatic standby emergency generator with diesel engine drive and above ground fuel storage tank. All generators shall be sized to run all pumps at station.
- I.9.2.5. Refer to Chapter IV.6 – Section 407, "Emergency Pump Engines", for technical specifications on standby emergency pump engine with fuel storage tank. All emergency pump engines shall be sized to run all pumps at station.
- I.9.2.6. Reference Appendix for Back Up Power Decision Matrix.
- I.9.2.7. All pumping station emergency back-up systems, separate or combined, are to be sized to peak flow.
- I.9.3. **SMART METER**  
All pumping stations shall have a Smart meter to monitor electrical conductivity. The electrical provider shall supply the meter.
- I.9.4. **FLOW METER**  
Class I, II, III and IV pumping stations, both rehabilitation and new construction, shall include an ultrasonic or magnetic flow meter (indicating, totalizing, data transmission via SCADA and recording capabilities). Ultrasonic meters shall have 24"Hx24"Wx18"D meter enclosure .1255052 aluminum standard white. Magnetic flow meters shall have a by-pass configuration located within the fenced area.
- I.9.5. **SOLIDS MANAGEMENT**  
Class IV pumping stations, both rehabilitation and new construction, with an influent pipe diameter greater than 30" shall include an influent solids management system. Solids management system

# ***JEA Water and Wastewater Standards***

## ***433 Submersible Wastewater Pumping Stations***

shall consist of Dual-Channel mechanic bar screen (0.75" to 1.5" spacing require with debris storage, offsite deposal method and odor control, or grinder/communicator/macerator.

### **I.9.6. ODOR CONTROL REQUIREMENTS**

All stations with a maximum peak flow greater than 441 GPM shall include electrical service sizing, 30A breaker, water line and wall penetrations with duct work, all stubbed-out in gravel area for future odor control.

### **I.9.7. ELECTRICAL CONTROL BUILDING**

For stations with more than 3 pumps and/or with motors larger than 75 HP and/or have a full load amperage of greater than 400 amps, an electric power and control building shall be provided in accordance with Prefabricated Concrete Enclosure standards in this section. Control building required if any of the below conditions exists:

- Pumps larger than 75 hp
- Station FLA > 400 amps
- Station has > 3 pumps

### **I.10. PUMP STATION FINAL INSPECTION**

Contractor shall schedule a final walk through (prior to substantial completion) in order to create a punch list for each project. List of attendees shall include but not be limited to the Contractor's representative, JEA representative (i.e. project inspector and project engineer), and designated JEA Operation's representative (i.e. O&M mechanical) personnel. Contractor shall be required to provide a crew complete with all necessary equipment to allow observation of each station. The Contractor's representative shall complete the Inspection Checklists in the Appendix of this specification for each new or rehabilitated pump station and have the JEA attendees provide original signatures/names on the signature blocks.

## **II. SUBMERSIBLE PUMPS**

### **II.1. GENERAL REQUIREMENTS**

Equipment furnished and installed shall be fabricated, assembled, erected and placed in proper operating condition in full accordance with drawings, specifications, engineering data, instructions and recommendations of the equipment manufacturer, unless exceptions are noted and approved by JEA.

### **II.2. PUMP OPERATING CONDITIONS**

II.2.1. Pump performance shall be stable and free from cavitation and noise throughout the specified operating head range at minimum suction submergence. Pump shall be designed so that reverse rotation at rated head will not cause damage to any component.

II.2.2. Operating conditions and unit sizes shall be as shown on the drawings. Pump shut-off head shall be a minimum of 15% greater than the pump design head for the "all pumps on" condition, such that a pump with a design point of 500-GPM at 100-FT-TDH must provide a shut-off head greater than 115-FT-TDH, unless otherwise approved by JEA. When possible, the pump selection shall be made in the center of the family of curves.

### **II.3. SHOP DRAWINGS AND PUMP TAGS**

Prior to commencing the pumping station installation and/or the furnishing of replacement pumps, the pump distributor shall submit for approval, detailed and dimensioned shop drawings for pumps including factory

# *JEA Water and Wastewater Standards*

## *433 Submersible Wastewater Pumping Stations*

curves of identical model pumps provided to JEA. The pump distributor shall furnish and deliver at the time of acceptance for use of the pumping station and/or of the replacement pump(s) by JEA, 3 computer compact diskette (CDs) (Microsoft Word) containing Operation & Maintenance data and motor and pump nameplate data (including serial numbers) for each pump supplied. The pump supplier shall provide a vinyl or aluminum placard or tag which indicates all operating conditions of the pumps, including name plate data, impeller size and part number, design flow, TDH, and other pump related data. The tag shall be placed (with adhesive) inside the front panel of the pump control panel or as directed by JEA.

### **II.4. PUMP EQUIPMENT**

Pumping equipment shall be as listed in AS-603 and premium quality submersible non-clog pumps for sewage service. Pumps shall be as listed in the JEA Standards Approved Materials section. Wet-pit pumps shall be complete with a submersible electric motor, floor-mounted discharge base and elbow, guide rails, motor electrical cable (minimum 50 feet in length) to connect at the demarcation box (no splicing allowed) and all other appurtenances specified or otherwise required for proper operation. Dry-pit pumps shall be complete with a submersible electric motor, electric cable (min. 50 feet in length), maintenance free cooling system, pump support legs and all other appurtenances specified or otherwise required for proper operation. Major pump components shall be of gray cast iron. All exposed nuts, bolts, washers, anchor bolts and other fastening devices shall be 316 stainless steel.

### **II.5. SOLID HANDLING PUMP CONSTRUCTION (WET-PIT AND DRY-PIT PUMPS)**

#### **II.5.1. IMPELLER**

The impeller casing shall have well-rounded water passages and smooth interior surfaces free from cracks, porosity, blowholes, or other irregularities. The impeller shall be a semi-open or enclosed one-piece casting with not more than two non-clog passages and must pass a minimum 3 inch solid (unless written approval from JEA's Pump Station Committee). Screw impellers are not acceptable. The interior water passages shall have uniform sections and smooth surfaces and shall be free from cracks and porosity. The impeller shall be dynamically balanced and securely locked to the shaft by means of a key and self-locking bolt or nut.

#### **II.5.2. MECHANICAL SEALS (UPPER AND LOWER SEALS)**

Pumps shall have mechanical seals, which shall require neither maintenance nor adjustment and shall be readily accessible for inspection and replacement. The seals shall not rely upon the pumped media for lubrication and shall not be damaged if the pump is run un-submerged for extended periods while pumping under load. Mechanical seals shall be solid hard faced, (not laminated type). The bottom seal shall be tungsten carbide or silicon carbide material. The top seal may be either carbon-ceramic, tungsten carbide or silicon carbide material.

#### **II.5.3. MATING SURFACES**

All mating surfaces (pump assembly), of major components shall be machined and fitted with O-rings where watertight sealing is required.

#### **II.5.4. DISCHARGE BASE AND ELBOW**

For wet pit applications, the pump manufacturer shall furnish a discharge base and elbow (minimum 4"x 4") for the pump supplied. The base shall be sufficiently rigid to firmly support the guide rails, discharge piping and pump under all operating conditions. The base shall be suitable for bolting to the floor, (bolting to a standard 1" thick metal plate, see details on drawings), of the wet well. The face of the discharge elbow inlet flange shall make contact with the face of the pump discharge nozzle flange. The pump and motor assembly shall be a "quick disconnect" type

# *JEA Water and Wastewater Standards*

## *433 Submersible Wastewater Pumping Stations*

connected to and supported by the discharge base and guide rails allowing the pump to be removed from the wet well and replaced without the need for unbolting any flange, lowering the liquid level or requiring operating personnel to enter the wet well. Pump shall be provided with a sealing flange and guide rail-sliding bracket. The bracket shall be designed to obtain a leak proof seal between flange faces as final alignment of the pump occurs in the connected position. The bracket shall maintain proper contact and a suitably sealed connection between flange faces under all operating conditions. Metal to metal mating surfaces are acceptable, if machine finished.

### **II.5.5. MOTORS 1800 RPM**

The pump shall be driven by a totally submersible electric motor at 1800 RPM. Pump motor shall be of sufficient horsepower as to be non-overloading over the entire length of the pump curve. The stator housing shall be a watertight casing. Motor insulation shall be moisture resistant, Class F, 180 degree C. at a minimum. All motors shall be VFD rated including class H winding insulation. Motor shall be NEMA Design B for continuous duty at 40 degree C ambient temperature and designed for at least 15 starts per hour. All motors over 3 HP shall be 3-phase. Motor bearings shall be anti-friction, permanently lubricated type. Motor shall be designed to operate in a totally, partially or non-submerged condition without damage to the motor. Pump cable assembly shall bear a permanently embossed code or legend indicating the cable is suitable for submerged use. Cable sizing shall conform to NEC requirements. The cable shall enter the pump(s) through a heavy-duty cast iron assembly with grommet. An epoxy seal may be added to this cable entrance assembly to improve water tightness. The system used shall ensure a watertight submersible seal. The cable shall terminate in a junction chamber. Junction chamber shall be sealed from the motor by a compression seal.

### **II.5.6. MOTORS 3600 RPM**

The pump shall be driven by a totally submersible electric motor at 3600 RPM (max.). Pump motor shall be of sufficient horsepower as to be non-overloading over the entire length of the pump curve. The stator housing shall be a watertight casing. Motor insulation shall be moisture resistant, Class F, 180 degree C. at a minimum. All motors shall be VFD rated including class H winding insulation. Motor shall be NEMA Design B for continuous duty at 40 degree C ambient temperature and designed for at least 30 starts per hour. Bearings: shall have a minimum L10 life of 50,000 hours. Seals: tandem seal system consisting of two independent seals manufactured from Tungsten Carbide. Impeller: shall have Hard Iron Impellers (25% chrome cast iron with leading edges hardened to Rc 60) Volutes/suction covers: shall require ASTM A-48, Class 35. Refer to section XI approved materials.

### **II.5.7. ROTATING PARTS**

All rotating parts shall be accurately machined and shall be rotational balance. Excessive vibration shall be sufficient cause for rejection of the equipment. The pump impellers shall be re-balanced after being trimmed.

### **II.5.8. DRY-PIT APPLICATIONS**

For dry-pit applications, the pump shall be limited to 1800 RPM (max.). The pump should have a reliable, maintenance free cooling system that circulates a cooling liquid in a closed loop through a cooling jacket, and transfers the heat to the pumped liquid by heat exchange. A system that circulates the pumped liquid in a cooling system is not acceptable. The pump should be equipped with support base to secure the pump and facilitate the installation.

## **II.6. GUIDE RAILS**

# *JEA Water and Wastewater Standards*

## *433 Submersible Wastewater Pumping Stations*

For wet pit applications, pump shall be equipped with one or more guide rails (no cable wire assembly). Guide rails shall be 316 SS one piece welded design with all operating surfaces sanded and smooth (no couplings) and a minimum of 2 inch diameter and sized to fit the discharge base, sliding bracket and shall extend upwards from the discharge base to the access hatch cover at the top of the wet well.

### **II.7. LIFTING CHAIN**

For wet pit applications, a heavy-duty chain and shackle appropriately sized (3/8" minimum) for removing and installing the pump shall be selected and provided by the pump manufacturer. Unless approved otherwise by JEA, the lift chains shall be shackled to a heavy duty 316 stainless steel lifting bail (see details) attached to the pump/motor housing for removal and reinstallation. Three feet of excess chain above the top of the wet well shall be provided to expedite removal. A chain/motor electric cable holder shall be provided and appropriately sized to accommodate the lift chains and motor electrical cables provided without deformation. Chain/electric cable holder shall include extra heavy-duty 3/8" rod hooks for attaching control floats, lifting chains, and other wet well accessories (6 hooks minimum) and be located on the side of the wet well hatch opening opposite of the discharge piping. The chain, shackles, lifting bail, and cable holder shall be 316 stainless steel.

### **II.8. PAINTING**

Exterior of pump shall be coated with manufacturer's standard finish (powder coated epoxy finish is preferred, not required).

### **II.9. INSTALLATION**

For wet pit applications, pump discharge base shall be leveled, plumbed and aligned into position to fit connecting piping. The discharge base shall be solidly secured to the wet well floor using a 1" thick steel hold-down plate (see details) and appropriately sized 316 stainless steel anchors then grouted after initial fitting and alignment and before final bolting of the discharge piping. This work shall be inspected by JEA prior to any liquid being allowed into the wet well. After final alignment and bolting, pump discharge base and all connections shall be inspected. If any movement or opening of any joints is observed, any and all piping, including pump discharge base, shall be corrected.

### **II.10. PUMP WARRANTY**

The following warranty conditions shall also apply to existing pump replacements.

- II.10.1. The manufacturer shall warrant to JEA for permanent installation in municipal sewage service non-clog submersible pump and motor against defects in materials and workmanship including normal wear and tear to the following parts for a period of 5 years, mechanical seals, bearings, shafts, motor electrical cables and motor stators. The warranty shall include no less than 100% coverage for original equipment manufacturer (OEM) parts and in-shop labor for pump/motor repairs for the full 5 years at NO COST to JEA. This warranty shall not apply to parts that fail due to abuse, neglect, mishandling, or acts of God. The warranty period shall commence upon the date of final acceptance for the pumping station and/or of the replacement pump by JEA. Note: Sand, rags and other debris is normal in JEA's service area, JEA shall allow no exceptions on pump failures within the 5 year warranty for this reason.
- II.10.2. Verification of guarantees of performance and warranty certificate shall be indicated in the shop drawing submittal and in the Operation and Maintenance discs.
- II.10.3. The pump distributor shall employ and make available proficient manufacturer-authorized service technicians to perform service calls to pumps supplied to JEA on a 24-hour basis, 7 days a week.



# ***JEA Water and Wastewater Standards***

## ***433 Submersible Wastewater Pumping Stations***

The pump distributor shall provide service technicians, company-owned service vehicles equipped with lifts/booms capable of retrieving all sizes of submersible pumps from wet wells, all necessary tools, test and safety equipment, etc., that are required to make field repairs. Service personnel shall adhere to all JEA Safety Rules & Regulations and be trained and certified for confined space entries and carry liability and workers compensation insurance.

- II.10.4. During the warranty period, the pump distributor shall at no cost to JEA, within 24 hours, repair and re-install the subject pump or provide a loaner pumps which can be transported, installed, and capable of maintaining operation of JEA's sites. The location address, contact names, phone numbers (including emergency, mobile, etc.) fax numbers of the manufacturer-authorized warehouse, service center shall be indicated in the shop drawing submittal and in the Operation & Maintenance compact disks.

### **II.11. LOW FLOW SIMPLEX PUMP STATIONS**

Low flow simplex pump stations shall be approved by JEA, case by case, for single residential use only.

#### **II.11.1. PUMP TYPE**

Pump shall be of the grinder type with an integrally built grinder unit and submersible motor. The grinder unit shall be capable of macerating all material in normal domestic and sewage including reasonable amounts of foreign objects such as small wood, sticks, plastic, thin rubber, sanitary napkins, disposable diapers and the like into a fine slurry that will pass freely through a pump and 1-1/4" discharge pipe connection, at a minimum. The minimum pump performance shall include a 0-40 GPM total flow range and a 25-100' total head range. The design engineer shall be responsible for the final design and pump selection to meet all operating conditions. Approved pumps and wet well shall meet or exceed these specifications. See Wastewater construction detail S-50 for additional construction details.

#### **II.11.2. GRINDER PUMP MOTOR**

Stator winding shall be of the open type with Class F insulation rated for 155°C (311°F) maximum operating temperature. Winding housing shall be filled with a clean, high dielectric oil that lubricates the bearing, seals, and transfers the heat from the winding and rotor to the outer shell. Air filled motors, shall not be considered equal. Motors shall have heavy-duty bearings to support the pump shaft, take the radial, and thrust loads. Single-phase motors shall have a heat sensor thermostat and overload attached to the top end of the motor windings to stop if the motor winding temperature reaches approximately 300°F. The high temperature shut off will cause the pump to cease operation should a control failure cause the pump to run in a dry wet well. The thermostat shall reset automatically when the motor cools to a safe operating temperature. NOTE: Contractor must verify and confirm motor voltage and phase before the equipment can be released to production and manufacturer. If not approved otherwise by JEA, the common motor, pump and grinder shaft shall be of 316 stainless steel, threaded, on the pump end, to accept the impeller and grinder assembly.

#### **II.11.3. MECHANICAL SEALS**

The motor shall be protected by two seals mounted in tandem in a seal chamber. The seal chamber shall be oil filled to lubricate the seal faces and transmit the heat from the shaft to the outer motor shell. Seal faces shall be carbon ceramic on the upper seal and tungsten carbide or silicon carbide on the bottom seal. An electrode shall be mounted in the seal chamber to detect any water from entering the chamber through the lower seal. Water in the chamber shall cause a red light to turn

# *JEA Water and Wastewater Standards*

## *433 Submersible Wastewater Pumping Stations*

on at the control box. The signal shall not stop the motor but act as a warning only, indicating that service is required.

### **II.11.4. IMPELLER/CUTTER ASSEMBLY**

The pump impeller shall be of the recessed type to provide an open and unobstructed passage through the volute for the ground solids. The impeller shall be constructed of cast iron, bronze or stainless steel and shall be threaded onto a stainless steel shaft. The grinder assembly shall consist of a grinder, an impeller, and a shredding ring and shall be mounted directly below the volute passage. Grinder impeller shall be threaded onto a stainless steel shaft and shall be locked to the shaft with a screw and a washer. Both the grinder and the shredding ring shall be constructed of 440C stainless steel hardened to 55 to 60 on the Rockwell C scale or JEA approved equal.

### **II.11.5. CASTINGS**

All iron casting shall be class 30 cast iron and the exterior shall be paint with epoxy coating. All pump and motor fasteners shall be 316 stainless steel.

### **II.11.6. MATING SURFACES**

All mating surfaces of the pumps major components shall be machined and fitted with O-rings where seating is required.

### **II.11.7. POWER CORD**

The motor power and control cord shall be 40' long (min), multi-conductor type and shall be fastened by means of a cord grip in the top of the pump. The motor shall contain a waterproof junction box, which will provide space to connect the power cord to the motor leads. The motor leads shall seal between the motor housing and the junction chamber by means of an isolation fitting around each wire. The power cord shall have a green carrier ground conductor that attaches to the motor flange.

### **II.11.8. DISCHARGE BASE AND ELBOW (OPTIONAL)**

The pump manufacturer shall furnish a discharge base and discharge elbow for the pump supplied. The bases shall be sufficiently rigid to firmly support the guide rails, discharge pipe and pump assembly under all pumping conditions. The base shall be bolted to the well floor and sealed on the wet well exterior to prohibit any intrusion or leakage from the wet well. The face of the discharge elbow inlet flange shall make contact with the face of the pump discharge nozzle flange. The pump and motor assembly shall be a quick disconnect type connected to and supported by the discharge base and guide rails allowing the pump to be removed from the wet well and replaced without the need of unbolting any flange, lowering the liquid level or requiring operating personnel to enter the wet well. Pump shall be provided with a sealing flange and a guide rail sliding bracket. The bracket shall be designed to obtain a leak proof seal between the flange faces as final alignment of the pump occurs on the connected position. The bracket shall maintain proper contact and suitably sealed connection between flange faces under all operating conditions.

### **II.11.9. ROTATING PARTS**

All rotating parts shall be accurately machined and shall be in perfect rotational balance. Excessive vibration shall be sufficient for rejection of the equipment. The impellers shall be rebalanced after being trimmed.

### **II.11.10. GUIDE RAILS (OPTIONAL)**

# *JEA Water and Wastewater Standards*

## *433 Submersible Wastewater Pumping Stations*

Pump may be equipped with guide rails. Guide rails shall be a minimum of ¾" diameter, or 1" square and sized to fit the discharge base and the sliding bracket and shall extend upwards from the discharge base to that access hatch cover at the top of the wet well. Guide rails and brackets (including fasteners) shall be 316 stainless steel.

### **II.11.11. LIFTING CHAINS**

A heavy-duty chain or cable and shackle appropriately sized (3/8" minimum) for removing and installing the pump shall be selected and provided by the pump manufacturer. The chain or cable shall be 316 stainless steel and attached to a stainless steel hook at the top of the wet well.

### **II.11.12. WET WELL**

The basins shall be fiberglass, filament wound and with a minimum size of 3' diameter, by 4' deep. Basins shall have consistent wall thickness (.25" min.) and provide impact resistance structural integrity with anti-floatation collar on bottom. Basins shall be corrosion resistant, and have either full skid-proof aluminum (3/8" thick min) or fiberglass top with 316 S.S. hold-down bolts rated at 200psi minimum live load. A 4"-(min.) flexible entry boot with 316 stainless steel fastener, compression ring and stainless steel bands or cast iron hub with rubber seals shall be provided.

### **II.11.13. ELECTRICAL CONTROLS**

II.11.13.1. Unless otherwise approved by JEA, the panel shall be as followings: a NEMA 4X fiberglass or plastic control panel shall be furnished with each pumping unit to be installed. The control panel enclosure shall be molded of glass reinforced polyester resins, which are chemically resistant to corrosive atmospheres. The resin system shall be pigmented to impart a gray color to the enclosure and be resistant to ultraviolet light. The enclosure shall be of one piece, weatherproof construction with smooth exterior and interior. The enclosure shall be fitted with a closed cell neoprene gasket cover. The enclosure shall be provided with back panel mounting provisions and be attached to the wall of the house or a 4x4 pressure treated post or 3" aluminum post anchored 24" (min) into the ground (bottom of panel located 18"-24" above finished grade). The cover shall be hinged with a heavy-duty corrosion resistant stainless steel piano hinge. The cover shall be lockable by means of two (2) high quality combination stainless steel latches and padlock hasps. The enclosure shall be provided with external mounting feet. These mounting feet shall be of fiberglass and molded as an integral part of the enclosure.

II.11.13.2. The panel shall include a double pole 20 amp main disconnect breaker minimum, alarm circuit fuse, control circuit fuse, I.E.C. rated motor contactor, "Klixon" type overload or an internal pump overload, pump hand-off auto switch, pump run light, seal leak light, start and run capacitors, start relay, terminal blocks, ground lug and all necessary wiring and brackets.

II.11.13.3. The control panel shall be fitted with a red polycarbonate alarm light. The light shall be approximately 3" high and 3-1/2" diameter. The globe shall be mounted on top of the enclosure with a neoprene gasket. The alarm shall have a bright glow and flash during high water conditions. The alarm light will go out when the water level drops.

II.11.13.4. All internal wiring shall be neat and color-coded. Each wire shall be a different color or stripe (except for ground), and all incoming wires shall terminate into a box clamp type terminal block (except incoming power).

# *JEA Water and Wastewater Standards*

## *433 Submersible Wastewater Pumping Stations*

II.11.13.5. A schematic diagram shall be permanently fastened to the inside of the enclosure. An Installation and Service Manual shall also be included with each control panel.

II.11.13.6. The control panel shall be U.L. listed as an assembly.

II.11.13.7. The wet well should contain two control (on, off) floats or one wide-angle float (single differential float switch) operating over a 90-degree swing with the tether length between the float body and the pivot point controlling the pre-set on-off range. A high water level alarm float shall also be provided. All floats shall be wired to the control panel for control of the pump.

### **II.11.14. WARRANTY**

#### **II.11.14.1. PUMP WARRANTY**

The following warranty conditions shall apply to new and existing pump stations. The manufacturer shall warrant to JEA for permanent installation in municipal sewage service submersible pump and motor against defects in materials and workmanship including normal wear and tear to the following parts for a period of 5 years: mechanical seals, bearings, shafts, motor electrical cables and motor stators. The warranty shall include no less than 100% coverage for original equipment manufacturer (OEM) parts and in-shop labor for pump/motor repairs for the full 5 years at NO COST to JEA. This warranty shall not apply to parts that fail due to abuse, neglect, mishandling, or acts of God. The warranty period shall commence upon the date of final acceptance for maintenance by JEA (i.e., that the pump station is totally complete) of the pumping station and/or of the replacement pump by JEA. Verification of guarantees of performance and warranty shall be indicated in the shop drawing submittal and in the Operation and Maintenance documents.

#### **II.11.14.2. WET WELL**

The manufacturer of the basin/structure and pump removal assembly shall warrant the materials against defects for at least five (5) years after the date of acceptance by JEA. Defects area defined, at a minimum, as cracking, delimitation or leaking. The warranty shall require the manufacturer to supply all necessary labor, materials and equipment to repair defects to the satisfaction of JEA. The contractor and/or manufacturer shall not make any exemptions or exception to the above stated conditions or warranty.

### **II.12. FRAME AND COVERS**

Access frame and covers shall be suitable size for pumping units furnished and shall be constructed of skid-proof aluminum with a minimum load rating of 300 lbs. /sq. ft. or H-20 traffic loading when called for on the drawings. Frame and covers shall be furnished complete with stainless steel staple assembly (NOT RECESSED) for the locking mechanism, hold-open device, upper guide holder and cable holder. If door is not within a private fenced area, the locking mechanism shall be recessed type. Access covers shall be double door for Class II stations and triple door for Class III stations. Access covers shall be hinged to open as indicated on the drawings. Hatches shall be sized to provide a 4-inch minimum clearance between hatch and pump volute (measured from all sides and includes the pump and rail system). Minimum size total hatch opening shall be 42 inches by 48 inches for Class II stations and 42 inches by 96 inches for Class III stations. All hinges, fasteners and miscellaneous hardware shall be 316 stainless steel. For tamper proof and security purposes, the hinges shall be bolted to the door(s) with stainless steel carriage bolts and nuts.

# *JEA Water and Wastewater Standards*

## *433 Submersible Wastewater Pumping Stations*

The nuts shall be welded to the bolts on both the door(s) and frame with 316L. JEA will provide pad locks, as required.

### **III. PUMP STATION ELECTRICAL**

#### **III.1. ELECTRICAL SERVICE**

The Contractor shall provide complete new electrical service for each lift station, including coordination of electrical service selection and approval by JEA and the serving electrical utility company. Each lift station electrical service shall include complete primary and secondary electrical service equipment, metering and installation in accordance with these standards and the serving electrical utility company requirements. Unless specifically unavailable from the serving electrical utility company, the electrical service to each lift station shall be three phase. The basis of design lift station electrical service to be requested from the serving electrical utility company shall be as follows:

- III.1.1. 20 HP and below: 240/120 volt, 3 phase, open delta, full voltage motor starting, 15 starts per hour for 1800 or 30 starts hour 3600 rpm pumps
- III.1.2. 21 HP thru 40 HP: 480/277 volt, 3 phase, wye, full voltage motor starting, 15 starts per hour for 1800 or 30 starts hour 3600 rpm pumps
- III.1.3. 41 HP and above: 480/277 volt, 3 phase, wye, reduced voltage motor starting, 15 starts per hour for 1800 or 30 starts hour 3600 rpm pumps
- III.1.4. The lift station design engineer shall contact the serving electrical utility company and obtain written documentation of the availability of the service requested. The electrical service documentation to be obtained from the serving electrical utility company shall identify each of the following basis of design issues:
  - Electrical service voltage and phase
  - Electrical service point of connection
  - Type of motor starting required (full voltage or reduced voltage)
  - Maximum number of starts per hour permitted
  - Maximum available fault current
- III.1.5. The electrical service documentation obtained from the serving electrical utility company shall identify all applicable electrical utility company rules, regulations and fees. Additionally, the lift station electrical design engineer shall obtain a schedule that identifies when the requested electrical service would be available from the electrical utility company.
- III.1.6. If it is determined that the requested electrical service is not available from the electrical utility company, the design engineer shall submit an alternate basis of design recommendation for review and approval by JEA before proceeding with the lift station electrical design.
- III.1.7. The use of 208/120 volt, 3 phase, wye service shall not be permitted. For locations where the serving electrical utility company can only provide 3 phase wye services, the lift station electrical service shall be 480/277 volt, 3 phase, wye. For locations where the serving electrical utility company can only provide 240/120 volt single phase service, the pump motors shall be limited to a maximum of 7.5 HP. Three phase pump motors shall be provided. Variable frequency drive

# *JEA Water and Wastewater Standards*

## *433 Submersible Wastewater Pumping Stations*

motor starters shall be used to operate the three phase motors from the single phase electrical service.

- III.1.8. Electrical service size shall be based on these standards and N.E.C. requirements. The minimum electrical service size shall be 200 amps. Where the electrical service requirements exceed 200 amps, but are less than or equal to 400 amps, the electrical service size shall be 400 amps. Above 400 amps, the electrical service size shall be selected by the lift station electrical design engineer.

### **III.2. CONTROLS SELECTION GUIDE**

Below is a selection guide to determine the type of panel required:

- Variable Frequency Drives (VFD)
- A Cross Line contactors (ACL)

III.2.1.1. 0-7.5HP, 1P to 3P VFD Duplex only, Panel is to be sized for no AC.

III.2.1.2. 0-20HP, ACL, 240VAC Service; If larger than 20HP service shall be upgraded to 480VAC.

III.2.1.3. 0-40HP, ACL, 480VAC Service

III.2.1.4. 41-75HP or FLA < 400A, VFD, 480VAC, Panel is to be sized for no AC and Heat sinks vented out the back.

III.2.1.5. 76-200HP or FLA  $\geq$  400A or > 3 Pumps, VFD, In a building. Please contact JEA for further details.

Note that 208VAC shall not be permitted

### **III.3. ELECTRICAL EQUIPMENT**

#### **III.3.1. DRAWINGS**

Drawings are provided for Across the Line and Variable Frequency Drive designs on the JEA web site. All panels shall be built based on the latest drawings. These drawings are a template of how the overall Control Panel is to be designed. Note the drawings will need to be changed based on the voltage, pump size and the number of pumps. Keep existing format of drawings and only change Title Block.

III.3.1.1. Prior to building all drawings shall be modified and submitted for approval in AutoCAD 2007 DWG format and PDF for review by JEA.

III.3.1.2. Variables for the Across the Line design are wire size, enclosure size, main surge suppression, circuit breaker, contactor size, SIMOCODE volt/current module rating and generator disconnect switch.

III.3.1.3. Variables for the VFD design are wire size, enclosure size, circuit breaker, VFD, reactors and generator disconnect switch.

III.3.1.4. A Control Panel Detail List shall be provided for quotation and design purposes. List will include items as the voltage and FLA. Included shall be detail additional Inputs if

# ***JEA Water and Wastewater Standards***

## ***433 Submersible Wastewater Pumping Stations***

required for such items as Generator Monitoring, Odor Control, Potable Water Presser and other inputs.

III.3.1.5. Key electrical drawings as power distribution and I/O shall be laminated, attached to the door and in color. Drawings shall be printed on 8.5 x 11 if 11 x 17 is too large to fit on the door.

III.3.1.6. Full set of electrical drawings printed with a Laser Printer and in color shall be inserted in the door pocket. Ink jet is not accepted.

### **III.3.2. PANEL ENCLOSURES**

III.3.2.1. All enclosures and heat shields shall be powder coated white. Before powder coating enclosures they shall be degreased, cleaned and treated with phosphate process.

III.3.2.2. All insides of the Enclosures shall be Rated NEMA 12/3R with no ventilation to the outside.

III.3.2.3. All Enclosures shall be fitted with 3-Point Latch.

III.3.2.4. All enclosures shall have Marine Grade Aluminum heat shields on the top, front, back and side, unless mounted inside a building. They shall be fabricated from .125 Marine Grade Aluminum.

III.3.2.5. Enclosures shall have pockets mounted on the inside of the door.

III.3.2.6. The enclosure shall have a twelve gauge steel, formed, removable sub panel. The sub panel shall be degreased, cleaned, treated with phosphate process, then primed and painted with white industrial grade baked enamel.

III.3.2.7. The maximum size of an aluminum enclosure shall be no taller than 60" high or 60" wide with 12" floor stands for a total height of 60". Any enclosure that requires a larger size shall use 316 stainless steel. These enclosures shall be fabricated from .125 Marine Grade Aluminum.

III.3.2.8. Aluminum enclosures with free standing bases shall have the bases manufactured out of 316 stainless steel.

### **III.3.3. ACL CABINET REQUIREMENTS**

The minimum size of an enclosure shall be 42" Height x 42" Wide x 10" Deep with a 36" Wide Door. These enclosures shall be mounted on poles. If panel requires a larger than 42 x 42 x 10 enclosure, a floor standing enclosure with 12" floor stands with an enclosure height of 48" shall be used. Enclosure total height 60"

### **III.3.4. 1 PHASE TO 3 PHASE VFD CABINET REQUIREMENTS**

Minimum enclosure size for 1P to 3P VFD cabinets shall be 48" high by 36" wide by 16" deep. These enclosures shall be fabricated from .125 Marine Grade Aluminum. Enclosure shall be mounted on 12" floor stands. Enclosure shall be sized to accommodate the heat load without Air Conditioning. Refer to Heat Load Calculations section of this document to size panel correctly. Above panel does not require heat sinks to protrude from rear.

# *JEA Water and Wastewater Standards*

## *433 Submersible Wastewater Pumping Stations*

### III.3.5. 3 PHASE VFD CABINET REQUIREMENTS

- III.3.5.1. Minimum enclosure size for a 40HP VFD cabinets shall be 60" high by 48" wide and 20" deep on 12" floor stands. The maximum enclosure height shall not exceed 72". The sides of the enclosure may be extended no more than three inches from the door. Refer to Heat Load Calculations section of this document to size panel.
- III.3.5.2. VFD's installed in an enclosure outside will be built in a NEMA 12/3R enclosure with the drives heat sinks vented. Refer to drawings for further details.
- III.3.5.3. VFDs shall be bolted to a removable plate that will then be connected to the back of the enclosure with a gasket. The back of the enclosure shall have studs to attach the plate to. This plate is to be adequately designed to support the VFD. Enclosure cutout shall be sized a minimum of 2.75" wider and 3.5" higher on each side of the manufacturer recommended cutout for 40HP VFDs. This will result in a cutout that is no less than 5.5" wider and 7" higher than the manufacturer's specification. Additionally this distance will increase proportionately with the size of the VFD. For example: 80HP VFDs require a cutout that is 5.5" wider and 7.0" higher on each side (a total of 11" wider and 14" higher) of the manufacturer specified cutout. This requirement is to ensure that a future replacement of a VFD will allow for different VFD dimensions.
- III.3.5.4. The rear sunshield shall have a removable cover with handles to allow access to the VFD heat sinks for cleaning and maintenance. The heat shield will have studs sticking out with wing nuts for the removable cover.

### III.3.6. COMPONENTS

Components to build a control cabinet are classified as sole sourced or non-sole sourced as listed below.

- III.3.6.1. Sole Sourced items are items in the drawing's bill of material that shall not be substituted. These items are the radio, PLC, Input/Output modules, communication module, intelligent motor controls, UPS and 4-20ma surge suppression.
- III.3.6.2. Non-sole sourced items such as Power Supply, Transformer, Circuit Protection and others may be substituted for an equivalent device. The specifications of the devices shall meet or exceed the items listed in the bill of material. Any items found to not meet specification must be replaced at the panel builder's expense.

### III.3.7. WIRING

- III.3.7.1. All Wire Colors in the panel shall follow the UL508A standards.
- III.3.7.2. Wire type #12 AWG and smaller shall be Hook-Up/Lead tinned copper, # 18 AWG stranded minimum.
- III.3.7.3. Control Wiring  
All control cabinet wiring to the PLC and control devices shall be 18 AWG and terminated with ferrules. Control Wiring shall be numbered / lettered at each end. Wire numbers / letters shall be flattened polyolefin heat shrink markers for permanent wire and cable identification.



# *JEA Water and Wastewater Standards*

## *433 Submersible Wastewater Pumping Stations*

### III.3.7.4. Power Wiring

Ampacity rating shall be a maximum of 75C. All wires going from distribution block to the pump breaker and motor contactor shall be sized for 140% of motor's FLA.

### III.3.7.5. Field Wiring

III.3.7.5.1. All field wiring shall be ground burial rated.

III.3.7.5.2. All control wires shall be tin plated and #12 AWG with dielectric grease applied to both ends to prevent corrosion.

III.3.7.5.3. All control wires shall be labeled at both ends for tracing.

III.3.7.5.4. Analog wires shall tin plated with a foil and braided shield.

III.3.7.5.5. VFD rated cable shall be used from the VFD to the demarcation box.

III.3.7.5.6. Field wiring colors:

Motor Wires	240V = Blue, Orange, Black 480V = Brown, Orange, Yellow
Over Temperature	Hot = Black Common = White
Seal Fail	Hot = Red: Common = Orange Ground = Green
High Well	Hot = Blue Common = White/Blue Stripe

### III.3.8. TERMINALS

The minimum size shall be 4mm. The spring portion of the clamp shall be fabricated of a chrome nickel spring steel of high tensile strength and shall be solid, without perforation. The chrome nickel spring steel spring tension mechanism shall provide the installer the opportunity to directly insert solid or ferruled conductors without having to utilize tooling to open the clamping mechanism. The terminal block shall be designed to accept solid and/or stranded copper conductors without requiring special preparation, such as crimps, ferrules or tinning. Proportional clamping shall ensure mechanical and electrical connection integrity without damage to the conductors of various sizes throughout the rated range. The design of the terminal block shall not prevent or interfere with the use of wire preparation methods, such as crimps, ferrules or tinning. The pullout force shall be a minimum of 6 times that specified in VDE 0611 (Resistance to Vibration Test for Terminal Block). The current bar and clamping yoke shall have traverse grooves to increase the force required for conductor pull out and "Gas tight" connection. The voltage drop also shall remain virtually unchanged. Gas tightness will be per DIN 41640, part 76.

### III.3.9. MANUAL TRANSFER SWITCH

# *JEA Water and Wastewater Standards*

## *433 Submersible Wastewater Pumping Stations*

A NEMA 3R enclosed manual transfer switch shall be supplied if a generator set is not installed on-site. The Manual Transfer Switch (200 or 400) amps shall be equal to or greater than current rating of the main breaker.

### **III.3.10. ACROSS THE LINE START SPECIFICATIONS**

#### **III.3.10.1. Intelligent Motor Control**

Across the Line Starter shall be controlled by an intelligent motor control. The motor control shall consist of 4 discrete inputs and 2 discrete outputs. Display interface shall display Warnings, Faults + History, Operational data such as Line Voltage, Current, Power and I/O Status. The display will also have the ability to control from the keypad and switch the modes from Hand, Off, Auto and Override. Profibus DP interface built into the device required.

III.3.10.2. Decoupling modules shall be required on all non-Wye power systems such as a Delta.

III.3.10.3. Voltage/Current modules shall be sized based on Motor's FLA.

#### **III.3.10.4. Contactors**

III.3.10.4.1. All contactors shall be NEMA rated.

III.3.10.4.2. Device shall be manufactured and tested as a NEMA device; IEC equivalent will not be accepted

III.3.10.4.3. Minimum size contactor shall be NEMA Size 1.

III.3.10.4.4. Fractional size contactors shall not be acceptable.

III.3.10.4.5. Contactors shall be equipped with double break

#### **III.3.10.5. Thermal Magnetic Circuit Breakers**

Thermal magnetic circuit breakers shall be used for the Main, Emergency and Pump breakers. As a minimum, the breakers must comply with the standards as follows.

III.3.10.5.1. Circuit breakers shall be minimum "E" frame.

III.3.10.5.2. "E" frame circuit breakers shall contain a self-test "Trip Selector" permitting a mechanical simulation of the over current tripping device.

III.3.10.5.3. Protector operators shall be quick make, quick break and trip free.

III.3.10.5.4. Shall be rated a minimum of a 460 Volt @ 14 KAIC for 240 Volt systems and 600 Volt @ 18KAIC for 460/480 Volt systems.

III.3.10.5.5. The thermal and magnetic elements shall operate independently and multiple pole breakers shall be designed with common trip bar breaking all poles when a fault is received on any pole.

#### **III.3.10.6. Main and Emergency Breakers**

# JEA Water and Wastewater Standards

## 433 Submersible Wastewater Pumping Stations

III.3.10.6.1. The electric utility company servicing the utility shall provide the maximum available fault current rating for each electrical service. Each panel shall be UL rated for the maximum available fault current.

III.3.10.6.2. The Trip Rating or Setting shall be calculated by taking the largest Pump Breaker's Amps + the Nameplate Amps of all the other Pumps + 10Amps (auxiliary loads) = Normal Main Breaker Trip Setting.

III.3.10.6.3. The minimum size breaker will be 200. Where the breakers trip setting is greater than 200 amps and less than or equal to 400 amps the breakers shall be rated at 400 amps. Where the breakers trip setting is greater than 400 amps the main breaker shall be rated as determined by the lift station electrical design engineer.

### III.3.10.7. Across The Line Pump Breakers

The Trip Rating or Setting shall be calculated using the Pump Motor Nameplate Amps x 200% for Across the Line Starters.

### III.3.11. VARIABLE FREQUENCY DRIVE BREAKERS

Breakers shall be selected and sized for maximum ratings per manufacturer's recommendation.

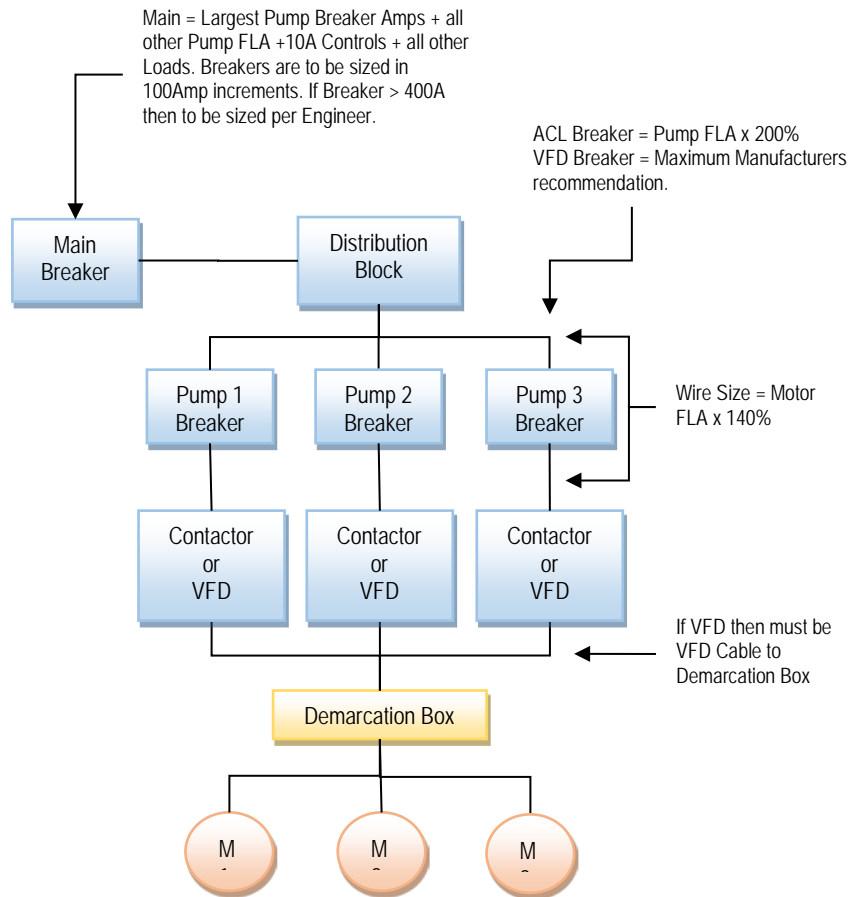

# JEA Water and Wastewater Standards 433 Submersible Wastewater Pumping Stations

## III.3.12. VARIABLE FREQUENCY DRIVE SPECIFICATIONS

III.3.12.1. Reference Section 495 Variable Frequency Drive Specifications for full details.

III.3.12.2. All VFD's shall come pre-programmed to the description of the VFD Float Backup Functional as described below.

III.3.12.3. All drawings shall come with a parameter sheet, on the drawing, with instructions for drive set up on Profibus and have backup float capability.

III.3.12.4. VFD Float Backup Functional.

III.3.12.5. Each VFD shall be wired with a Hand, Off and Auto switch. The three modes of operation are described below.

- Off – The drive is disabled.
- Manual – The drive shall turn on and ramp up to maximum speed.
- Auto – If the VFD selector switch is put into Auto and PLC Communication to the drive is ok then the drive will be controlled over the Profibus communication. If communication is ever lost to the VFD the Communication OK relay will drop out and control the VFD from the Float Control Relay. The Communication OK relay is controlled by the PLC and is to be energized as long as the VFD Communication is OK. Below is the connection diagram for the hardwired interface to the VFD.

Below is the connection diagram for the hardwired interface to the VFD.

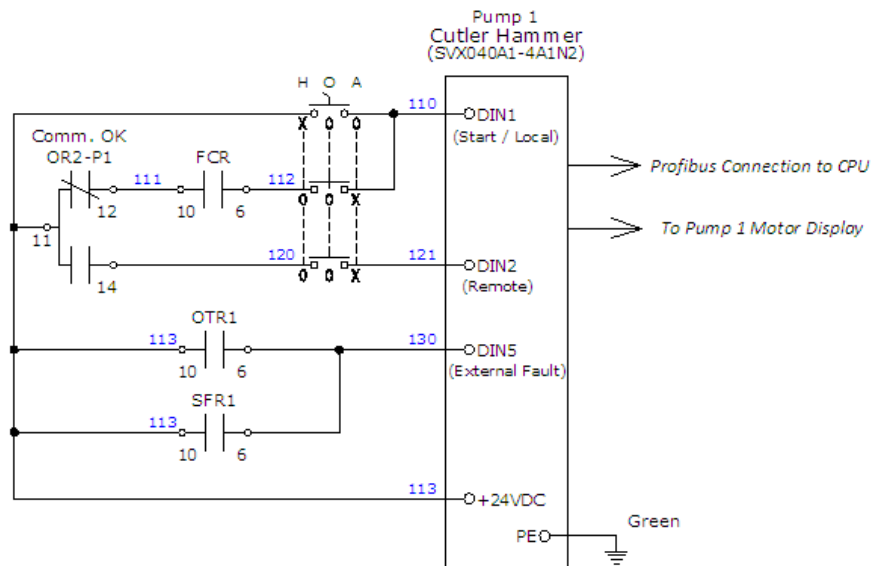

III.3.12.6. Heat Load Calculations For Gasketed / Unvented Enclosures

All heat calculations shall be provided showing surface area, internal heat load of components broken out, Watts per square foot and any other pertinent data. This data shall be submitted with the enclosure drawing for approval.

## *JEA Water and Wastewater Standards*

### *433 Submersible Wastewater Pumping Stations*

- III.3.12.6.1. The evaluation of the heat load on an enclosure, include the following:
- Total surface area of the enclosure in sq. ft.
  - Internal heat load [load and duty cycle to be considered in calculation]
  - Maximum allowable internal temperature [113F]; with an assumed outside temperature[95F]
- III.3.12.6.2. Enclosure surface area is the primary factor in determining its ability to dissipate heat.
- Surface Area =  $2[(A \times B) + (A \times C) + (B \times C)] \div 144$
  - Where the enclosure size is A x B x C in inches.
  - This equation includes all six surfaces of the enclosure.
  - If any surface is not available for transferring heat (for example, an enclosure surface mounted against a wall), that surface's area should be subtracted.
- III.3.12.6.3. For any temperature rise calculation, the heat generated within the enclosure or internal heat load shall be known. This information can be obtained from the supplier of the components mounted in the enclosure. Any internal heat calculation shall include but is not limited to the following components:
- Transformer Power Supply UPS PLC Circuit Breakers Heat Load Main All Pump circuit breakers taking into consideration duty cycle.
  - VFD Heat Load:  
If VFD is inside the enclosure, assume Heat Load = (746W x HP x 3%). If VFD heat sink is out back, assume Heat Load = (746W x HP x 3%) x 10%. Note: the 10% is from current manufacturer's statement that with heat sinks out the back only 10% of the heat will be dissipated inside the enclosure. Other manufacturers may require a greater percentage and must adjust the formula accordingly.
  - VFD Duty Cycle
    - For two pumps VFD applications assume worst case of one pump running continuously.
    - For three pumps VFD applications assume worst case of two pumps running continuously.
- III.3.12.6.4. Enclosure Temperature Rise ( $\Delta T$ )
- Example:
- What is the temperature rise that can be expected from a 72 x 72 x 20 in. painted white enclosure designed to control 3 VFD's with external mounted heat sinks?
- Solution:
- Surface Area =  $2[(72 \times 72) + (72 \times 20) + (20 \times 72)] \div 144 = 112 \text{ ft}^2$
- Internal Heat Load (Min)

# JEA Water and Wastewater Standards

## 433 Submersible Wastewater Pumping Stations

Component	Load	Full Load Loss	Loss
Control Transformer	50%	21.5w	11w
24VDC Power Supply		15w	15w
CPU 313C-2DP		14w	14w
Analog Input Module		1w	1w
Communication Module		6w	6w
3 Pole 200 Amp [2]	33% (65amps per drive)	80w per breaker at 200 amps	53w
[2] 50 HP VFD	100%	112w per drive	224
Misc.			13w
Total			337w

\*Full Load loss data from component specifications sheets.

- Watts per Square Foot = total internal watts / surface area = 337/112 = 3 Watts/Square Foot
- Temperature Rise  $[\Delta T]$  = 15 degrees F

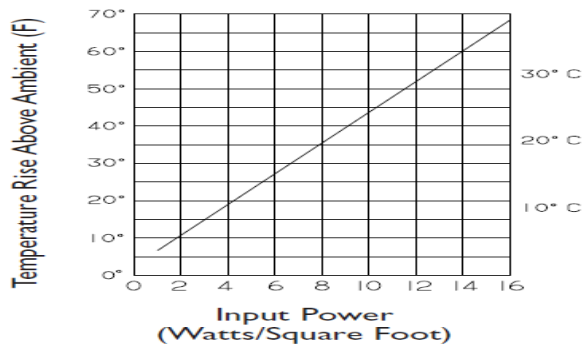

### III.3.12.7. Air Conditioning

Reference JEA Facilities Standards Manual Division 23. Only buildings will require air conditioning shall meet the specifications below.

III.3.12.7.1. Air conditioners shall be rated NEMA 4X and Corrosion Resistant.

III.3.12.7.2. Buildings shall require heating strips.

III.3.12.7.3. AC Units shall carry a minimum of a 3 year warranty in a corrosive environment.

### III.3.12.8. Surge Suppression

Surge Protective Devices (SPD) for 120VAC and above shall be UL1449 Third edition.

# *JEA Water and Wastewater Standards*

## *433 Submersible Wastewater Pumping Stations*

III.3.12.8.1. The Main Disconnect shall have a Type 1 SPD rated NEMA 4X. It will have a minimum surge capacity of 50kA at 8x20us

III.3.12.8.2. The Control Panel shall have a minimum Type 2 SPD with a surge capacity of 40kA at 8x20us.or above.

III.3.12.8.3. The 4-20ma surge suppression shall be a JEA standard approved product.

### III.3.12.9. Additional Field Wiring Requirements

Some sites require additional inputs based on external field requirements. Below is a list of inputs for different field requirements. Generator Input requirements as listed.

- Discrete Inputs – Generator Fault,
- Transfer Switch Normal,
- Transfer Switch Emergency,
- Generator Running,
- Normal Power Available
- Fuel Leak,
- Analog Input 4-20ma – Fuel Level

### III.3.12.10. UL Labels

The entire control system shall bear a UL 508A serialized label "Enclosed Industrial Control Panel". The use of the label "Industrial Control Panel Enclosure" without the UL508A serialized label shall not be acceptable.

### III.3.12.11. Warranty

III.3.12.11.1. The Panel Manufacturer shall supply to JEA a three (3) year (min.) unconditional warranty after completion or acceptance of MCC Panel on all parts supplied by the manufacturer, excluding parts supplied by JEA.

III.3.12.11.2. The warranty shall include materials and installation and shall constitute complete replacement and delivery to the site of materials and installation of same to replace defective material or defective workmanship with new materials/workmanship conforming to the specifications.

III.3.12.11.3. The Panel Manufacturer shall also be responsible to ensure that Component Manufacturer's Warranty which exceeds the Panel Manufacturer's warranty is honored.

## III.4. COMPONENTS EXTERNAL TO THE PANEL

### III.4.1. FLOATS

- High Well Alarm – Shall have one S40NC that is red.
- Start – Shall be a S40NO with green electrical tape above the float to indicate start.
- Stop – Shall be a S40NO with red electrical tape above the float to indicate stop.

# *JEA Water and Wastewater Standards*

## *433 Submersible Wastewater Pumping Stations*

### **III.4.2. WELL LEVEL TRANSDUCER**

The submersible level sensor shall be a solid-state instrument designed to continuously measure and transmit liquid level data. The transducer shall have a 4-20ma output with 24VDC supply. The transducer shall be calibrated for 0-24' of water. Transducer shall have conduit adapter, 100 feet of cable and be re-buildable. The transducer shall not have a breathing (vent line) or boxes. Transducers shall have manufacturer's three-year warranty from date of installation. The transducer shall be in stainless steel housing. Wire specs are as follows: conductor size 18 AWG, 16/30 TC insulation is .010 polyethylene cable is two conductor together with a 19 AWG drain wire and an overall aluminum Mylar Wrap. Cable jacket is .035 Black Polyurethane, nominal O.D. is .215. Color of conductors shall be red and black or JEA approved equal.

### **III.4.3. FORCE MAIN PRESSURE TRANSDUCER**

Every Lift Station shall have a Force Main Pressure Transducer. Transducer is to be rated 0-100PSI. Transducer shall have a minimum 3 year warranty.

### **III.4.4. POTABLE WATER PRESSURE TRANSDUCER**

Every Lift Station is required to have a Potable Water Pressure Transducer which shall meet the following requirements:

- Display for pressure readings and programming interface
- Buttons for programming the device
- Lower/Upper range adjustments for (zero/span)
- DAC output adjustment
- Ability to zero the transducer with the press of a button
- Configured for a -100 PSIG range and a 4-20ma output
- Minimum 3-year warranty

### **III.4.5. DEMARCATION BOX**

A Demarcation box shall be used as an isolation point between the wet well and the motor control center panel. All wiring between the motor control center and wet well shall be interconnected at this point. Demarcation Box is divided into a base that is vented and a top that is NEMA 4X rated. Demarcation Box shall be fabricated from .125 Marine Grade Brushed Aluminum. Box shall be mounted so that doors face away from wet well. Only one pulling 90 degree ell at the base of the demarcation box is allowed. Conduit shall be stubbed up 3" from the base. The wire shall run in the open air at the base of the demarcation box with liquid tight cord connections at the bottom of the top demarcation box. Reference drawings and information below for more details.

III.4.5.1. Demarcation Top – Shall be 30" Width x 24" Height x 12" Depth, NEMA 4X, hinged door, 3-Point Latch with a padlock feature.

III.4.5.2. Demarcation Base – Shall be 30" Width x 36" Height x 12" Depth, vented on all 4 sides. Have a hinged door and two padlocking ¼ turn wing latches on the front of the door.

III.4.5.3. Terminals – Shall be mounted on removable back plate, terminal for each wire, terminal sized according to load and minimum terminal size shall be 4mm. Antioxidant compound shall be used on all terminals and wire connections.

III.4.5.4. Liquid Tight Cord Connections – Shall be made of cast aluminum.



# ***JEA Water and Wastewater Standards***

## ***433 Submersible Wastewater Pumping Stations***

III.4.5.5. All wires including spares shall be identified with heat shrink labels. All control wires shall have spade lugs.

### **III.4.6. POWER DISTRIBUTION PANEL**

Panel to distribute power to devices external to the control panel. It shall be fabricated from .125 Marine Grade Brushed Aluminum or 316 stainless steel. Reference site drawings for details.

### **III.4.7. RADIO POLE/TOWER**

The radio pole or tower shall provide communication to the SCADA cabinet to the remote master. To determine if a Pole or Tower is required a Radio Path Study shall first be conducted. The Radio Path Study shall be done using the same type of radio used in the SCADA panel and shall be a minimum of -86DB RSSI. If the height of the minimum -86DB RSSI level is less than or equal to 20' then a 20' Pole shall be used. If the height requirements are over 20' then a Tower shall be used. Refer to drawings for specifications on Pole and Tower.

## **III.5. SERVICE**

The manufacturers or representatives shall provide two hour on site emergency service for the first 12 months after commissioning. The manufacturer shall stock replacement components locally for emergency replacement as needed.

## **III.6. START UP**

The manufacturer or representative shall be present for startup at time designated by JEA.

## **III.7. OPERATING PROCEDURES**

MCC supplier shall provide written "Standard Operating Procedures" to JEA.

# **IV. PREFABRICATED CONCRETE BUILDING**

The prefabricated building system shall be factory assembled, pre-tested, shipped to the site, and suitably anchored to the respective concrete foundations. In the case of a conflict between this specification section and the current JEA Standards, the more stringent of the two requirements shall apply. The enclosure shall be approved by JEA. The enclosure design and construction shall conform to all applicable federal, state, and local building codes and standards including the current Florida Building Code, D1.1 Structural Welding Code, ACI-318-02 and ACI-318R-02. The enclosure shall be guaranteed to be completely weather-tight under all weather conditions for a period of three (3) years (min). Leaks, which occur during the period, whether through roofs, walls, doors, accessory equipment, or materials, shall be repaired to the satisfaction of JEA at no additional cost to JEA. Contractor shall verify all openings and penetrations, and shall coordinate with the manufacturer prior to casting.

## **IV.1. DESIGN REQUIREMENTS**

IV.1.1. The enclosure shall be constructed of solid, one-piece concrete panels. Minimum outside dimensions of the building shall be 11'- 8" x 28'-0". The minimum interior clear height shall be 10'-0". Panels shall be bolted or welded together and joints caulked inside and out to make the building weatherproof. The wall panels shall be minimum 3-1/2" thick solid panels of concrete with primary structural reinforcement of steel bars and welded wire fabric. Wall panel assembly shall develop strength to resist the design wind loads. Wall panels shall be continuous from base to leave with no horizontal joints.

# *JEA Water and Wastewater Standards*

## *433 Submersible Wastewater Pumping Stations*

- IV.1.2. The roof shall have a gable profile with the ridge parallel to the long dimension and shall have a minimum 4" thick concrete panel extending over the walls to act as a drip edge. The roof shall contain primary reinforcement of steel bars and welded wire fabric as well as secondary reinforcement of polypropylene fibers.
- IV.1.3. The interior finish on the walls shall be ¾" plywood panels with plastic laminate suitable for equipment mounting and insulated to R-14. The ceiling shall be 5/8" gypsum and insulated to R-21. All fasteners and nails shall be 316 stainless steel.
- IV.1.4. The exterior surfaces of the walls shall have a stucco texture finish. The exterior shall be finished with a cementitious base coating and a topcoat of textured 100% acrylic. The topcoat shall be of the same manufacturer as the cementitious base coating. Colors shall be selected after the award of the contract Exterior flashing and fasteners shall be 316 stainless steel.
- IV.1.5. Caulking shall be provided at all bases, corners, eaves, doors, and other openings to provide a completely weather-tight installation. Sill angles and doorframes shall be caulked in place and sealed.
- IV.1.6. All necessary erection hardware, fasteners, trim, flashing, closures and other accessories necessary for a complete building shall be furnished. The enclosure shall be assembled in accordance with the building manufacturer's instructions. All members shall be carefully leveled. All welding shall be in accordance with AWS D1.1 Structural Welding Code.

### **IV.2. DOORS AND HARDWARE**

The building shall be provided with a pair of 2'-6" x 7'-0" fiberglass reinforced plastic (FRP) doors for equipment installation and a 3'-0" x 7'-0" FRP personnel door as indicated on the drawings. The color of the door shall be selected after award of the contract. Hardware shall be furnished and installed by the door manufacturer. The hardware shall be 316 stainless steel provided for the building and shall include mortise locks on each door set with interchangeable core cylinders. Interchangeable core shall have Contractor's core in cylinder. Contractor core shall be provided with control key and registered change keys. Contractor to coordinate door hardware lock mechanism with the JEA representative. Hinges shall be heavy-duty stainless steel. The location of hardware items shall be in accordance with DHI "Recommended Locations for Builders' Hardware". Hardware shall be stainless steel and furnished complete with machine screws, bolts, and other attachments as required. The Contractor shall furnished complete specifications and catalog cuts of each item offered. Reference JEA Facilities Standards Manual Division 8.

### **IV.3. ELECTRICAL**

The manufacturer of the building shall provide to the Contractor any requirements necessary for the installation of the electrical equipment and conduits by the Contractor as indicated on the drawings. This shall include recommended conduit penetration and sealing methods to ensure the weather-tight integrity of the building.

### **IV.4. STRUCTURAL DESIGN**

The applicable building code shall be the latest Florida Building Code. The enclosure shall be designed to resist overturning and sliding forces resulting from wind loading. Embedments to be cast into the slab for anchorage shall be designed and provided by the building supplier. Structural design shall be performed by a Professional Engineer registered in the State of Florida and submittal of building components shall bear his/her seal. The building shall be designed for the following criteria (at a minimum):

- Roof live load, lb per sq. ft. of horizontal 20 psf projection (no live load reduction is permitted)

# *JEA Water and Wastewater Standards*

## *433 Submersible Wastewater Pumping Stations*

- Wind Load 120 mph, 3 second gust.

### **IV.5. PAINTING AND FINISHES**

All surfaces to receive paint shall be cleaned of any grease, dust, or dirt. Pre-finished surfaces shall be masked or otherwise protected to avoid damage from spilled paint, overspray, or spatter. Factory finished surfaces, which have become damaged during shipping, assembly, or erection shall be touchup painted with materials supplied by the building manufacturer. No other finish shall be accepted. All touchup painting shall produce a final finish satisfactory to JEA.

### **IV.6. DRAWINGS AND DATA TO BE SUBMITTED**

IV.6.1. Complete specifications and drawings covering the doors and a complete hardware schedule shall be submitted in accordance with the Submittals section. Drawings shall indicate an elevation of the door, details of construction, assembly and erection details, profiles and thickness of materials, anchors, reinforcements, hardware coordination, and finish. Drawings shall be accompanied by the manufacturer's installation manual, indicating standard recommendations and details of erection. The hardware schedule shall indicate each item of hardware required, manufacturer's name, manufacturer's number or symbol, and finish.

IV.6.2. Complete drawings and data shall be furnished showing anchor bolt locations, sizes, and projections; details of sidewall, end wall, and roof framing; transverse cross-sections; locations of all openings; details of louver; flashing details; and erection instructions. Color samples of manufacturer's standard finishes shall be submitted. Drawings and data shall be in accordance with the Submittals section.

### **IV.7. CERTIFICATION**

A letter of certification signed and sealed by a Professional Engineer registered in the State of Florida shall be submitted for the structural framing, anchorage and covering panels of the building system.

## **V. VALVES**

The contractor shall furnish and install check valves, plug valves, and appurtenances as shown on the drawings and as specified in JEA Water and Wastewater Standards Manual. Wastewater Valves and Appurtenances. Check valves shall be lever and weight style shall meet the following additional requirements. Rubber disc facing shall operate on a 316 stainless steel shaft connected to a steel outside lever and cast iron adjustable weight. Check valve shall include renewable seat and disc. Valves shall meet AWWA Standard C508 and rated at 150 psi (min.) working pressure.

## **VI. TESTING**

### **VI.1. PUMP FACTORY TESTS**

The pump manufacturer shall perform the following tests on each pump prior to shipment.

VI.1.1. Megger the pump motor and cable for insulation breaks or moisture intrusion.

VI.1.2. Prior to submergence, run pump, dry and check for correct rotation.

VI.1.3. Pump shall be run continuously for 30 minutes in a submerged condition, with a minimum submergence of 10 feet.

# *JEA Water and Wastewater Standards*

## *433 Submersible Wastewater Pumping Stations*

- VI.1.4. Pump shall be removed from test tank, meggered immediately for moisture and all seals checked for water intrusion.
- VI.1.5. Pumps shall be operated at a minimum of 6 points to establish the hydraulic curve. KW input shall be monitored and recorded. One test point shall be performed with discharge valve closed. Pumps shall develop appropriate capacity and head within Hydraulic Institute Standards without excessive noise, vibration or cavitation. If specifically requested by JEA, a vibration test shall be performed on each pump to demonstrate compliance.
- VI.1.6. For pumps less than 100 HP, the pump supplier shall submit copies of certified Hydraulic Institute test reports including factory pump curves of identical model pump (s) provided to JEA (in lieu of written certified test reports for each pump supplied).
- VI.1.7. For pumps 100 HP and greater, the above certified pump performance test (at a minimum) must be completed on each actual pump supplied. A JEA representative(s) shall be present to witness the certified test (JEA's travel expenses by JEA).

## **VI.2. FIELD ACCEPTANCE TESTING**

### **VI.2.1. PRE-FINAL INSPECTIONS**

Prior to final inspection, the Contractor shall conduct a pre-final site inspection (including energizing each pump), in the presence of a JEA representative. Any deficiencies noted at this time shall be corrected prior to scheduling of the final inspection.

### **VI.2.2. FINAL INSPECTION**

The Contractor shall be responsible for conducting the following field acceptance tests and start-up procedures in the presence of a JEA representative. The Contractor shall notify JEA, the Engineer and the pump manufacturer's representative 48 hours prior to start-up. The time and date of this final inspection shall be scheduled by JEA. The Contractor shall furnish all labor, piping, equipment, water and materials required to perform the acceptance testing. The Contractor shall ensure the force main is full of water prior to the pump test. The contractor shall submit proof of compliance with electric site grounding requirements. JEA will complete a final inspection checklist for acceptance. The Contractor shall demonstrate that the pump mounting and guide rail systems are operational. The Contractor shall remove and reinstall the pumps in the presence of the JEA representative, prior to conducting the performance test.

#### **VI.2.2.1. Pump Performance**

Prior to acceptance, as part of the final inspection, and prior to placing the station in operation, the Contractor shall conduct a pump performance test. Pumps shall operate according to the operating conditions indicated on the drawings without excessive vibration or overheating. Testing shall be performed using clean water. The Contractor shall supply water at its own expense to perform the required testing. Pumping rates shall be determined by pumping a calculated volume of water in a specified time interval. Head and flow conditions shall be measured and recorded. Water levels during testing shall fall within the pump control levels shown on the drawings. Amperage draws shall be monitored to determine effectiveness and efficiency of equipment. The test shall be repeated until satisfactory results are obtained. The test results shall be recorded on the Pump Test Report sheet included in the appendix section herein. If the Contractor is unable to demonstrate to JEA that the pumping unit performs

# ***JEA Water and Wastewater Standards***

## ***433 Submersible Wastewater Pumping Stations***

satisfactorily, the unit shall be rejected. The Contractor shall then remove and replace the defective unit at its own expense. Satisfactory performance includes, but is not limited to, the following:

### **VI.2.2.1.1. Pumps**

Pumps shall deliver rated GPM at rated TDH.

### **VI.2.2.1.2. Motors**

Running amperage shall be noted and recorded on each leg of power cord while pump is operating under full load.

VI.2.2.1.3. All self-test trip relays shall demonstrate ability to simulate a fault condition. All test results shall be recorded on the pump test report and be submitted to the Engineer.

VI.2.2.1.4. Pumps shall operate within 5 % of the approved, certified, head-capacity curve.

VI.2.2.1.5. Following performance testing, pumps shall be meggered for pump-moisture intrusion.

VI.2.2.1.6. Pump spare parts are not required unless specifically noted otherwise.

VI.2.2.1.7. For dry-pit submersible pumps, the closed loop cooling system shall provide adequate cooling, in accordance with pump manufacturer's recommendation, throughout the pumping range.

### **VI.2.3. SCADA INSPECTIONS**

A JEA representative shall conduct the following field acceptance test and start up procedures in the presents of the contractor.

## **VII. REFERENCE POINTS AND LAYOUT**

The Contractor shall be responsible for setting all grade stakes, lines and levels. The Contractor or Contractor's Surveyor will provide centerline of construction and will establish a benchmark. Any reference points, points of intersection, property corners, or benchmarks, which are disturbed during construction, shall be restored by a Land Surveyor registered to practice in the State of Florida, and all costs thereof shall be borne by the Contractor. The Contractor shall assume all responsibility for the correctness of the grade and alignment stakes.

## **VIII.PRECAST CONCRETE AND POLYMER CONCRETE WET WELLS**

### **VIII.1. PRECAST CONCRETE MATERIALS**

Wet well bases, sections and miscellaneous structures shall conform to the requirements of ASTM C478 (specification for precast concrete manhole sections and structures) except as modified herein. Cement shall meet the requirements of ASTM C150 (specification for Portland cement, type II). Concrete shall meet the minimum requirements for Class "A" as specified in JEA Water and Wastewater Standards Chapter II. 5. - Section 437- Concrete Work. Minimum wall thickness shall be 1/12 the inside diameter in inches plus 1 inch. Rings shall be custom-made with openings to meet indicated pipe alignment conditions and invert elevations. The Contractor shall submit shop drawings consisting of manufacturer's standard details of various sections, for approval, before placing order for structures.

# *JEA Water and Wastewater Standards*

## *433 Submersible Wastewater Pumping Stations*

### **VIII.2. POLYMER CONCRETE MATERIALS**

Wet well bases, sections and miscellaneous structures shall conform to the requirements of JEA Specification Chapter IV. 1. - Section 427 shall be custom-made with openings to meet indicated pipe alignment conditions and invert elevations. The Contractor shall submit shop drawings consisting of manufacturer's standard details of various sections, for approval, before placing order for structures.

### **VIII.3. BASES**

Bases for wet wells shall be cast integrally with the bottom section. The base section shall be set in a 12-inch (minimum) leveling course of granular material (57 stone) as shown on the drawings. For base and riser's the reinforcement shall be designed, signed and sealed by a Florida Registered Structural Engineer and shall be submitted with the shop drawings.

### **VIII.4. JOINTS**

Joint contact surfaces shall be formed with machined castings and shall be exactly parallel and specifically designed by a professional engineer. Joints shall be sealed with JEA approved joint sealer over the entire joint surface, with joints pre-primed. Joints shall be watertight. Upon completion of installation, excess joint sealer shall be trimmed flush with inside and outside surface of structure.

### **VIII.5. FLEXIBLE PIPE CONNECTOR**

A flexible pipe connector shall be used to connect the wastewater influent pipe to the precast concrete wet well.

#### **VIII.5.1. MATERIAL**

The Neoprene-EPDM material the connector is manufactured from shall conform to ASTM C443 and shall be a minimum of 3/8 inches (9.4mm) thick or greater. The material shall be resistant to ozone, weathering, aging, and chemicals, including acids, alkalis, animal and vegetable fats, oils and petroleum products.

#### **VIII.5.2. BANDS**

The stainless steel bands and screw assembly shall be a totally non-magnetic series 316 stainless steel.

#### **VIII.5.3. CONNECTOR**

The connector shall be of a size specifically designed for the specified pipe material and size. The connector may be installed in the wet well wall by the precast manufacturer in strict accordance with the recommendations of the connector manufacturer. During the invert construction stage, the interior annular space between the exterior of the pipe and the interior of the connector shall be filled with a Type II lean cement grout by the Contractor.

### **VIII.6. INSTALLING SECTIONS**

Wet well sections shall be set so the wet well will be vertical and with sections in true alignment. If not approved otherwise by JEA, the construction schedule for setting wet well base and riser sections shall be approved by a JEA representative. The JEA representative shall be present, on site, during this installation. During the handling of all wet wells, the contractor shall protect the wet well and not allow a chain, cable or other lifting line to damage the joint surfaces. Spreader bars, wood blocks or other devices shall be utilized to prevent damage to the wet well. Any wet well section or lid found to have defects, included but not limited to leaks and cracks shall be removed and replaced. Construction shall include:

# *JEA Water and Wastewater Standards*

## *433 Submersible Wastewater Pumping Stations*

- VIII.6.1. Cleaning all joint surfaces (remove all sand, oil, debris & other foreign items) and provide additional primer if recommended by the joint manufacturer.
- VIII.6.2. The joint sealant (JEA approved joint sealant) and the manhole surfaces shall be dry during the installation period (shall not be installed if wet or during rain events).
- VIII.6.3. Joint sealant is applied to both the top & bottom joint surfaces (Double Ring Method). The joint sealant shall be installed continuously around all joints with the ends placed butt-to-butt (not overlapped & no open gaps between sealants).
- VIII.6.4. The excess joint sealant shall be trimmed flush to the inside surfaces of the manhole. Trim the outside surfaces if an exterior joint sealant/tape is applied.
- VIII.6.5. Apply a special primer and an "Exterior Joint Sealant Membrane" to the outside surfaces of all manhole joints/seams, which are located below the top cone section. Apply the primer and joint membrane in accordance with the recommendations of the membrane manufacturer.
- VIII.6.6. Wet well with leaking joints (infiltration of ground water) will not be accepted by JEA. JEA will not accept leak repairs on new construction of wet wells. The leaking wet well is to be removed and replaced.

### **VIII.7. METALLIC NON-SHRINK MORTAR**

All holes in sections used for their handling and the annular space between the wall and entering pipes shall be thoroughly plugged with an approved, non-shrinking mortar or grout, applied and cured in strict conformance with the manufacturer's recommendations, so that there will be zero leakage through openings and around pipes. The mortar shall be finished smooth and flush with the adjoining interior and exterior manhole wall surfaces.

### **VIII.8. EXTERIOR JOINT SEALANT MEMBRANE, TAPE**

#### **VIII.8.1. GENERAL**

All exterior joints of wet well shall be sealed with a 12-inch wide (minimum) exterior joint sealant membrane tape.

#### **VIII.8.2. MANUFACTURER**

All exterior joints of wet wells shall be sealed with one 12 inch wide (minimum) exterior joint sealant membrane centered on joint. The tape shall be capable of sealing joints against groundwater infiltration. The installation of the membrane shall be in conformance with the recommendations of the manufacturer. Surface must be smooth, clean, dry and free of voids, loose aggregate, dirt or other matter that will hinder the adhesion of the membrane. A primer shall be used in accordance with the recommendations of the membrane manufacturer. If recommended by the manufacturer, heat shall be applied to all areas being sealed. The membrane shall be the type listed in the JEA Water and Wastewater Approved Materials Manual (See AS-501, but utilize 12 inch wide tape).

### **VIII.9. CORROSION PROTECTION**

#### **VIII.9.1. PRECAST CONCRETE**

Precast concrete wet well interior shall be lined as specified in JEA Water and Wastewater Standards Chapter IV. 6. - Section 446 Specialty Coatings and Linings. The exterior of the wet

# *JEA Water and Wastewater Standards*

## *433 Submersible Wastewater Pumping Stations*

well (below grade), shall be given two coats of bituminous water proofing materials which meets the coating requirements as specified for sewage manholes (Specification Chapter IV. 1. - Section 427).

### **VIII.9.2. POLYMER CONCRETE**

Precast polymer concrete wet well shall be utilized to provide corrosion protection.

## **IX. FIBERGLASS WET WELL**

### **IX.1. GENERAL**

Upon approval by JEA, the contractor may construct a fiberglass wet well in lieu of a precast concrete wet well. The fiberglass wet well shall be designed (signed and sealed) by a Florida Professional Engineer. The design shall include the operating conditions as noted on the drawings, a 24-inch (minimum) thick (12-inch thick inside the wet well and 12 inches thick outside the wet well) reinforced concrete hold-down base which extends 24 inches beyond the outside of the wet well, a 6-inch (minimum) thick reinforced concrete top slab, pump access frame and cover and other standard wet well features as shown on the drawings. Pumps shall be anchored to a 1-inch thick steel plate (see details on the drawings). The complete design (designed by a Florida Professional Engineer) must be submitted in the form of a shop drawing for JEA's review and approval. Fiberglass reinforced polyester wet wells shall be manufactured from commercial grade unsaturated polyester resin with fiberglass reinforcements. Unless approved otherwise by JEA, the wet well shall be a one-piece unit.

### **IX.2. MATERIALS**

#### **IX.2.1. RESIN**

The resins used shall be commercial grade unsaturated polyester resins.

#### **IX.2.2. REINFORCING MATERIALS**

The reinforcing materials shall be a commercial Grade "E" type glass in the form of mat, continuous roving, chopped roving, roving fabric, or a combination of the above, having a coupling agent that will provide a suitable bond between the glass reinforcements and the resin.

#### **IX.2.3. SURFACING MATERIALS**

If reinforcing materials are used on the surface exposed to the contained substance, it shall be a commercial grade chemical-resistant glass that will provide a suitable bond with the resin and leave a resin rich surface.

#### **IX.2.4. FILLERS AND ADDITIVES**

Fillers, when used, shall be inert to the environment and wet well construction. Additives, such as thixotropic agents, catalysts, promoters, etc., may be added as required by the specific manufacturing process to be used. The resulting reinforced plastic material must meet the requirement of this specification.

### **IX.3. FABRICATION**

#### **IX.3.1. EXTERIOR SURFACE**



# *JEA Water and Wastewater Standards*

## *433 Submersible Wastewater Pumping Stations*

The exterior surface shall be relatively smooth with no sharp projections. Handwork finish is acceptable if enough resin is present to eliminate fiber show. The exterior surface shall be free of blisters larger than 1/2 inch in diameter, delamination and fiber show.

### **IX.3.2. INTERIOR SURFACE**

The interior surface shall be resin rich with no exposed fibers. The surface shall be free of crazing, delamination, blisters larger than 1/2 inch in diameter, and wrinkles of 1/8 inch or greater in depth. Surface pits shall be permitted if they are less than 3/4 inch in diameter and less than 1/16 inch deep.

### **IX.3.3. DEFECTS NOT PERMITTED**

- Exposed fibers: glass fibers not wet out with resin.
- Resin runs: runs of resin and sand on the surface.
- Dry areas: areas with glass not wet out with resin.
- Delamination: separation in the laminate.
- Blisters: light colored areas larger than ½ inch in diameter.
- Crazing: cracks caused by sharp objects.
- Pits or Voids: air pockets.
- Wrinkles: smooth irregularities in the surface.
- Sharp Projection: fiber or resin projections necessitating gloves for handling.

### **IX.3.4. INSTALLATION OF BRACKETS**

Manufacturer or manufacturer certified field personnel shall glass in all stainless steel fasteners and brackets, discharge piping brackets, etc. Manufacturer of wet well shall be responsible for integrity of all field glassing.

### **IX.3.5. MARKING AND IDENTIFICATION**

Each wet well shall be marked with the following information.

- Manufacturer's name or trademark
- Manufacturing special number
- Total length and nominal diameter

## **IX.4. PHYSICAL REQUIREMENTS**

### **IX.4.1. LOAD RATING**

The complete wet well shall have a minimum dynamic-load rating of 16,000 ft-lbs when tested in accordance with ASTM 3753, Section 8, test methods D 790 and D 695. To establish this rating the complete wet well shall not leak, crack, or suffer other damage when load tested to 40,000 ft-lbs and shall not deflect vertically downward more than 1/4 inch at the point of load application when loaded to 24,000 lbs.

### **IX.4.2. STIFFNESS**

The wet well cylinder shall have a minimum pipe-stiffness value as shown in Table 1 (at a minimum) when tested in accordance with ASTM D3757, Section 8.

# JEA Water and Wastewater Standards 433 Submersible Wastewater Pumping Stations

Table 1: Stiffness Requirements (Minimum)

Length, Ft.	F/AY psi
10 to 20	2.01
21 to 30	3.02
31 to 40	5.24

Physical Properties:

		Hoop Direction	Axial Direction
a.	Tensile Strength (psi)	18,000	5,000
b.	Tensile Modulus (psi)	0.8 x 10 E6	0.7 x 10 E6
c.	Flexural Strength (psi)	26,000	4,500
d.	Flexural Modulus (psi) (no ribs - 48", 60", 72") (with ribs - 96", 144")	1.4 x 10 E6 7.0 x 10 E6	0.7 x 10 E6 0.7 x 10 E6

## IX.5. FIBERGLASS CONSTRUCTION METHODS

### IX.5.1. HANDLING

IX.5.1.1. The wet well shall not be dropped or impacted. Wet wells shall be chocked if stored horizontally. If wet wells must be moved by rolling, the ground transverses shall be smooth and free of rocks, debris, etc.

IX.5.1.2. FRP wet wells may be lifted by the installation of three lifting lugs as specified by the manufacturer on the outside surface near the top or by a sling or "choker" connection around the center. Use of chains or cables in contact with the wet well surface is prohibited. Wet wells may be lifted horizontally using one support point.

### IX.5.2. WET WELL INSTALLATION

Bottom of excavation should be compacted to 95% Standard Proctor Density. Pour reinforced concrete base a minimum of one foot deep and at least two feet larger than the fiberglass wet well outside diameter. As soon as the concrete has set-up enough to support the fiberglass wet well, lower the wet well into place. (Wet wells with fiberglass bottoms, should have rebar inserted into bottom reinforcement.). Pour a minimum of one foot of reinforced concrete on the inside, also a minimum of one foot deep and two feet from the fiberglass wet well wall on the outside of the fiberglass wet well. Insert "RAMNEK" type sealant on the outside of the fiberglass wet well around the bottom where the fiberglass and concrete come together.

### IX.5.3. WET WELL CUTOUTS

Cutouts in wet well wall shall be made with proper cutting tools such as jigsaw or hole saw. Do not use axe or other impact-type tools.

### IX.5.4. PIPE INSTALLATION

# ***JEA Water and Wastewater Standards***

## ***433 Submersible Wastewater Pumping Stations***

Make the cutout in the wet well wall equal to the outside diameter of pipe, plus 1/2 inch maximum. Grind the outside surface of the pipe and both the inside and the outside surfaces of the cutout in the wet well wall. Apply a priming agent to any PVC pipe being used before fiberglass lay-up. Insert the pipe through the cutout in the wall of the wet well. Apply fiberglass putty to the inside and the outside of the wet well wall cutout, filling openings between pipe and cutout. Make a good radius for the fiberglass lay-up. After putty has set-up, fiberglass the pipe into place. Use one layer of woven roving sandwiched between two layers of fiberglass mat. Allow fiberglass to completely set-up before backfilling. Manufacturer of wet well shall be responsible for integrity of field glassing.

### **IX.6. DESIGN FEATURES**

#### **IX.6.1. TOP SLAB SUPPORT**

Pour reinforced concrete slab support a minimum of two feet outside of fiberglass wet well wall and minimum of six inches thick.

#### **IX.6.2. DESIGN**

Fiberglass wet well system to be designed, signed and sealed by a Professional Engineer registered in the State of Florida. Resistance to uplift and traffic loading requirements shall be addressed in the design.

#### **IX.6.3. WET WELL TOP**

Wet well top shall be concrete and designed for H-20 Traffic loading. Hatches shall be as specified in this specification and as detailed on the contract drawings. Bottom of top slab and around side of hatch opening shall be fiberglass lined and shall meet all the requirements of this specification.

### **IX.7. WARRANTY**

The fiberglass manufacturer shall warrant the fiberglass wet well against defects for at least ten years after the date of acceptance by JEA. Defects are defined as cracking, delaminating, or leaking. The warranty shall require the manufacturer to supply all necessary labor, materials, and equipment to repair defects to the satisfaction of JEA. The Contractor and/or manufacturer shall not make any exemption or exception to the above stated conditions or warranty.

### **X. JUNCTION MANHOLES:**

The manhole nearest the wet well and all manholes receiving force mains shall conform to the JEA Water and Wastewater Standards Chapter IV. 1. - Section 427-Manholes. Junction manholes for pump stations shall be 5 feet inside diameter minimum.

### **XI. EXCAVATION**

#### **XI.1. GENERAL**

The limit of excavation shall be such to allow for placing and removing forms, installing sheeting, shoring, bracing, etc. The Contractor shall pile excavated material in a manner that will not endanger the work and will avoid obstructing sidewalks, driveways, power poles, etc. Drainage shall be kept clear.

#### **XI.2. VERTICAL SIDES (SHEETING, SHORING AND BRACING)**

When necessary to protect existing or proposed structures or other improvements, the Contractor shall maintain vertical sides of the excavation. The limit shall not exceed three feet outside the footing on a vertical plane parallel to the footing except where specifically approved otherwise by the Engineer. The

# *JEA Water and Wastewater Standards*

## *433 Submersible Wastewater Pumping Stations*

Contractor shall provide and install any sheeting, shoring, and bracing as necessary to provide a safe work area as required protecting workers, structures, equipment, power design and adequacy of all sheeting, shoring, and bracing. For excavations deeper than 20 vertical feet, which utilize sheeting, shoring or bracing, the sheeting, shoring and bracing plan shall be designed by a Florida Professional Engineer, (signed and sealed). This plan shall be submitted to JEA for review and approval, prior to construction. The construction of sheeting, shoring and bracing shall be in accordance with the approved plan. All major field modifications shall be approved by the professional engineer. The sheeting, shoring, and bracing shall be removed, as the excavation is backfilled in such manner as to prevent injurious caving. Excavation shall meet the Florida Trench Safety Act (an OSHA requirement) and OSHA Excavation Standards (29 CFR sub-part P 1926.650) at a minimum.

### **XI.3. SLOPING SIDES**

Where sufficient space is available, the Contractor shall be allowed to back slope the sides of the excavation. The back slope shall be such that the excavation shall be safe from caving. The type of material being excavated shall govern the back slope used, but in any case, the back slope shall be no steeper than 1 foot horizontal to 1 foot vertical without sheeting or shoring.

### **XI.4. DE-WATERING**

The Contractor shall keep excavation free from water by use of cofferdams, bailing, pumping, well pointing, or any combination as the particular situation may warrant. All de-watering devices shall be installed in such a manner as to provide clearance for construction, removal of forms, and inspection of exterior of formwork. It is the intent of these specifications that the foundation be placed on a firm dry bed. The foundation bed shall be kept in a de-watered condition a sufficient period of time to insure the safety of the structure. The excavation shall be protected from excessive rainfall, drainage and drying. The excavation shall be inspected and approved by JEA's representative before work on the structure is started. It is the intent of these specifications that the Contractor provides a relatively smooth, firm foundation bed for footing and slabs that bear directly on the undisturbed earth without additional cost, regardless of the soil conditions encountered. The Engineer will be the sole judge as to whether these conditions have been met.

### **XI.5. UNAUTHORIZED EXCAVATION**

Excavation for slabs, footings, etc., that bear on earth shall not be carried below the elevation shown on the drawings. In the event the excavation is carried on below the indicated elevation, the Contractor shall bring the slab, footing etc., to the required grade by filling with concrete having a minimum compressive strength of at least 3,000 PSI at 28 days.

## **XII. BACKFILL**

### **XII.1. BACKFILL MATERIAL**

Unless shown otherwise on the drawings, suitable soil (A-3 sand only, no clay or rocks larger than 3/4" size) shall be used for backfill around the wet well for a distance of two feet from the outside surface and extending from bottom of the excavation to the bottom of the top slab. The material chosen shall be free of large lumps or clods, which will not readily break down under compaction. This material will be subject to approval by the Engineer. Backfill material shall be free of vegetation or other extraneous material. Excavation materials which are to be used for fill or backfill may be stockpiled on site. Top soil should be stockpiled separately and used for finish grading around the structure.

### **XII.2. SCHEDULE OF BACKFILLING**

# *JEA Water and Wastewater Standards*

## *433 Submersible Wastewater Pumping Stations*

The Contractor may begin backfilling of wet well as soon as the concrete has been allowed to cure and the forms removed.

### **XII.3. BACKFILL**

Backfill shall be placed in layers of not more than 12 loose measure inches and mechanically tamped to at least 95% Standard Proctor Density. Flooding will not be permitted. Backfill shall be placed in such a manner as to prevent any wedging action against the structure.

## **XIII. WASH DOWN STATION**

### **XIII.1. WATER SERVICE PIPING**

Water service piping shall be 1½-inch diameter (minimum). Water meter, shall be 1½-inch diameter (minimum). Materials and installation shall meet JEA's standards for typical water service construction.

### **XIII.2. BACKFLOW PREVENTER**

The Contractor shall furnish and install a 1½ inch reduced pressure backflow preventer, which meets the requirements of JEA's Cross Connection Control Policy (see details on drawings).

### **XIII.3. WATER SERVICE & METER**

The Contractor/Developer shall secure the water for the pump station site by applying for either a commercial 1 ½-inch water only meter (if no irrigation water use is included with meter) or commercial 1 ½ inch irrigation meter (if irrigation water use is included with this meter). The Contractor/Developer is responsible for all JEA fees. The Contractor shall install the meter box and service in accordance with all applicable JEA Standard Details and Specifications and JEA will install the meter. The Contractor shall be responsible for the cost of all water used during construction and testing. The water service will then be transferred to JEA upon final acceptance of the pump station.

### **XIII.4. HOSE**

Wash-down hose to be white cover paper mill creamery wash-down hose with tapered nozzle. Hose length shall be sufficient to reach bottom of wet well from hose station.

## **XIV. SITE WORK**

### **XIV.1. SITE PLAN**

The site plans shall be designed site specific. The site plan shall indicate the actual site and orientation of all structures, panels and piping, at a minimum.

### **XIV.2. GENERAL**

All work shall be in accordance with the following specification sections, at a minimum: Chapter II. 1. - Section 406 - Site Preparation, Cleanup and Restoration, Chapter II. 2. - Section 407- Demolition and Abandonment, Section 408 - Excavation and Earthwork and Chapter II. 5. - Section 437 – Concrete Work. Slope concrete and site to drain towards street or other adjacent, JEA or City owned drainage facility.

### **XIV.3. DRIVEWAYS AND SITE**

All JEA pump stations shall be provided with a permanent site access road structure of traffic rated concrete or asphalt. The access roadway shall be 12' wide and have adequate fillets for turning a vehicle around, if needed. The driveway apron from the roadway to the pump station shall be concrete only.

# *JEA Water and Wastewater Standards*

## *433 Submersible Wastewater Pumping Stations*

### **XIV.3.1. CONCRETE**

All work under this section shall be of 3,000 PSI concrete with reinforcing wire or fiber mesh. Thickness of concrete shall be 6 inches (minimum).

### **XIV.3.2. EXPANSION JOINTS**

Expansion joints shall be pre-formed joint fillers meeting the requirements of AASHO M153 or AASHO 213 and cut to the true shape of the cross section, set to line and grade and held true while the concrete is being placed. The joint shall be edged and finished in a competent manner. These strips shall be left in place and shall be placed adjacent to the paving, curb driveway aprons, structures and pads, or as specified by the Engineer. Expansion Joints which are not adjacent to the structures listed above may be 1 inch by 4 inch pressure treated lumber or other approved materials and shall appear every 18 feet, at a minimum or be placed between truckloads of concrete that exceed the time limits specified in the JEA Water and Wastewater Standards Chapter II. 5. - Section 437 Concrete Work.

### **XIV.3.3. CONTRACTION AND CONSTRUCTION JOINTS**

Contraction and construction joints shall be placed and formed by means of an approved jointer template. The stem of the jointer shall be pressed into the freshly finished concrete forming a groove 1/2 inch deep. The edges of the groove and adjacent surface shall be neatly finished. Unless otherwise shown on the plans or designated by the Engineer, these joints shall be placed at 6-foot intervals between expansion joints.

### **XIV.3.4. SURFACE REQUIREMENTS**

The concrete shall be given a broom finish. The surface variations shall not be more than 1/4 inch under a ten-foot straight edge, nor more than 1/8 inch on a five foot transverse section. The edge of the concrete shall be carefully finished with an edging tool having a radius of 1/2 inch.

### **XIV.4. ROCK COVER**

When indicated on the drawings, the Contractor shall furnish and install 6 inches of No. 57 (1" nominal diameter) crushed limestone placed over a 10-mill plastic membrane.

### **XIV.5. FENCING**

Fencing shall be furnished and installed in accordance with details on the drawings.

## **XV. PERMITS**

The Engineer will supply the land-clearing permit. The Contractor shall secure and pay for all plumbing, electrical, right-of-way and other required permits. The Contractor shall make application and pay applicable fees for electric and water meters. The Contractor shall be responsible for all costs associated with utilities used during construction and testing of the pump station. Upon final acceptance or, if approved, following substantial completion of the project, the JEA Pump Station Manager shall, by letter to JEA, transfer services to JEA.

## **XVI. LANDSCAPING**

Plants shall be of the types and placed in the locations as indicated on JEA's Minimum Standards for Landscaping as included in the Sewage Pump Standard Details (Latest revision) and as approved by local landscape code enforcement.

## **XVII. SPRINKLER SYSTEM**

# *JEA Water and Wastewater Standards*

## *433 Submersible Wastewater Pumping Stations*

### **XVII.1. GENERAL**

Sprinkler system shall consist of a single main traveling around the perimeter of the pump station site. Sprinkler system shall form a complete loop and be connected to the hose station downstream of the backflow preventer, as indicated on the drawings. Sprinkler system shall be operated by a single stage timer located in the control panel. Sprinkler system shall be designed by the sprinkler supplier, which shall be a firm regularly engaged in the design and supply of sprinkler systems.

### **XVII.2. COMPONENTS**

XVII.2.1. Sprinkler system shall consist of mister heads on 2-foot tall, black, risers around perimeter of pump station paving at site. System shall provide 100% cover over the buffer zone (plant zone), while minimizing the over spray to less than 5% of the volume of water delivered. Provide irrigation to land between pump station and road paving.

XVII.2.2. Commercial grade, 12 inch pop-up, gear driven sprinklers may be used if necessary for this area only. Mister heads on risers shall be required around pump station perimeter.

### **XVII.3. SUBMITTALS**

Shop drawing submittals will be required on sprinkler system design and components.

### **XVII.4. DRAIN VALVE**

Sprinkler system shall include ½-inch solid brass automatic drain valves, Nelson #8819 or JEA pre-approved equal. Drain valve shall carry a 5-year warranty against failure and be installed in a plastic landscape valve box as depicted on drawings.

### **XVII.5. WATER SERVICE**

If applicable, an irrigation water meter service shall be provided for the sprinkler system. In this case, the Contractor may be required to secure the irrigation meter by submittal of a JEA irrigation meter application and payment of applicable fees. If available, reclaimed water should be utilized for all irrigation.

## **XVIII. INSPECTION CHECKLISTS AND REPORTS**

# JEA Water and Wastewater Standards 433 Submersible Wastewater Pumping Stations

## XVIII.1. JEA SUBMERSIBLE PUMP TEST REPORT

**PROJECT** \_\_\_\_\_ **DATE** \_\_\_\_\_

STREET ADDRESS \_\_\_\_\_

LONGITUDE \_\_\_\_\_ LATITUDE \_\_\_\_\_

WATER METER NO. \_\_\_\_\_

ELECTRIC METER NO \_\_\_\_\_

GENERATOR MAKE \_\_\_\_\_ GEN MODEL \_\_\_\_\_

GENERATOR SIZE (KW) \_\_\_\_\_ FUEL TANK (gal) \_\_\_\_\_

AUX PUMP SIZE (Inches) \_\_\_\_\_ HP \_\_\_\_\_ FUEL TANK (gal) \_\_\_\_\_

AUX. PUMP MAKE \_\_\_\_\_ AUX PUMP MODEL \_\_\_\_\_

AUX. ENGINE MAKE \_\_\_\_\_ AUX ENGINE MODEL \_\_\_\_\_

### PUMP DATA

MANUFACTURER \_\_\_\_\_ MODEL \_\_\_\_\_ HP \_\_\_\_\_

DISCHARGE SIZE (Inch) \_\_\_\_\_ VOLTAGE \_\_\_\_\_ PHASE \_\_\_\_\_

IMPELLER SIZE (Inch) \_\_\_\_\_ RPM \_\_\_\_\_ FLA \_\_\_\_\_

### WET WELL DESIGN

TOP ELEVATION \_\_\_\_\_ BOTTOM ELEVATION \_\_\_\_\_ DIAMETER \_\_\_\_\_

WW GALLONS PER FT \_\_\_\_\_ PUMP DESIGN POINT: \_\_\_\_\_ GPM @ (FT) \_\_\_\_\_

### TEST DATA

PUMP NUMBER	1	2	3	4
SERIAL NUMBER				
WATER ELEVATION START				
WATER ELEVATION STOP				
NET DRAWN DOWN (FT)				
TOTAL VOLUME (GALLONS)				
PUMP DURATION (SEC)				



## JEA Water and Wastewater Standards 433 Submersible Wastewater Pumping Stations

FLOW (GALLONS/MINUTE)				
GAUGE HEIGHT (FT)				
GAUGE (PUMPING PSI)				
PUMP TOTAL HEAD (FT)				
AMP READING (PER LEG)				

COMMENTS

---

CONTRACTOR REP

---

*Signature*

*Print name*

JEA INSPECTOR

---

*Signature*

*Print name*

JEA O&M REP

---

*Signature*

*Print name*

PUMP REP

---

*Signature*

*Print name*

ENGINEERING REP

---

*Signature*

*Print name*

# JEA Water and Wastewater Standards 433 Submersible Wastewater Pumping Stations

## XVIII.2. JEA MECHANICAL FINAL INSPECTION CHECKLIST

Project Name: \_\_\_\_\_  
 Street/Intersection/Address: \_\_\_\_\_  
 \_\_\_\_\_

		Checked
1	All valves operate from the closed to the fully open position	<input type="checkbox"/>
2	All valves seal when closed	<input type="checkbox"/>
3	All valves open turning to the left, and an indicating arrow is cast into the metal	<input type="checkbox"/>
4	All valves are easy to operate and have no sharp protrusions on hand wheels	<input type="checkbox"/>
5	All fasteners are SS, and mountings are tightened correctly	<input type="checkbox"/>
6	Discharge piping is installed plumb with both horizontal and vertical alignment provided	<input type="checkbox"/>
7	Pressure gauge provided	<input type="checkbox"/>
8	All pipework within the pump well complete, suitably anchored and guide rails in place	<input type="checkbox"/>
9	The pump cables are installed clear of guide rails and will not impede removal of the pumps	<input type="checkbox"/>
10	Turn the pump impellers by hand to ensure they are free to rotate	<input type="checkbox"/>
11	One piece flanged SS discharge piping provided in wet well	<input type="checkbox"/>
12	Pumps are clear of the well bottom, and securely mounted at the base plate	<input type="checkbox"/>
13	Check valve has vertical support	<input type="checkbox"/>
14	No rubbish at the bottom of the well which is likely to damage the pump when it is started	<input type="checkbox"/>
15	Check for correct pump rotation as indicated by the arrow on the pump casings	<input type="checkbox"/>
16	Turn the circuit breaker for each pump and ensure that the correct pump starts	<input type="checkbox"/>
17	Lower/raise the pumps to ensure they pass freely through the hatch opening with 4 inch clearance all sides; pumps slide smoothly on each guiderail and sit properly onto the stand	<input type="checkbox"/>
18	With one valve open, start the associated pump in manual mode and check for leaks, pump/motor vibrational noise, and well level drop	<input type="checkbox"/>
19	Shut valve and restart pump, checking for any leaks in piping/valves	<input type="checkbox"/>
20	Wetwell frame and cover constructed of aluminum with stainless steel assembly	<input type="checkbox"/>
21	Wetwell frame and cover constructed flush with top slab elevation	<input type="checkbox"/>
22	Drop bowl installed in wetwell and secured to wetwell wall	<input type="checkbox"/>
23	Site light installed in gravel pit	<input type="checkbox"/>
24	All above ground pipe/fittings/valves have approved coating applied(two coats)	<input type="checkbox"/>
25	Provide electronic photos of pump station showing overall site, valves, panels, etc.	<input type="checkbox"/>

OK

Rework Required

*JEA Water and Wastewater Standards  
433 Submersible Wastewater Pumping Stations*

Comments: \_\_\_\_\_

Contractor Rep: \_\_\_\_\_  
*Signature* *Print name*

JEA Inspector: \_\_\_\_\_  
*Signature* *Print name*

JEA O&M Rep: \_\_\_\_\_  
*Signature* *Print name*

# JEA Water and Wastewater Standards

## 433 Submersible Wastewater Pumping Stations

### XVIII.3. JEA GENERATOR FINAL INSPECTION & COMMISSIONING CHECKLIST

Project Name: \_\_\_\_\_

Street/Intersection/Address: \_\_\_\_\_  
 \_\_\_\_\_  
 \_\_\_\_\_

		Checked
1	Run generator in "manual" mode; check hertz, voltage, etc; verify operation of load bank	<input type="checkbox"/>
2	Verify certified affidavit of start-up and load testing from manufacturer's representative	<input type="checkbox"/>
3	Receipt of manufacturer's warranty (5-year)	<input type="checkbox"/>
4	Test "auto shut-down" on over speed circuit	<input type="checkbox"/>
5	Test to see if generator meets decibel requirements of <i>Specifications</i>	<input type="checkbox"/>
6	Simulate power failure (disconnect main breaker); verify automatic start of generator	<input type="checkbox"/>
7	Verify automatic transfer of power to emergency source; check for proper time delay between sequences.	<input type="checkbox"/>
8	Verify fuel tank and generator anchor bolts and related hardware is stainless steel.	<input type="checkbox"/>
9	Let run for ten (10) minutes	<input type="checkbox"/>
10	Restore utility power source; verify automatic transfer, cool-down cycle time, and shut down	<input type="checkbox"/>
11	Test load bank for proper operation	<input type="checkbox"/>
12	Ensure that separate circuits are provided for battery charger and block heater	<input type="checkbox"/>
13	Test block heater and battery charger for proper operation	<input type="checkbox"/>
14	Check for leaks	<input type="checkbox"/>
15	Check fuel monitoring gauges and interstitial gauges are accurate and working properly.	<input type="checkbox"/>
16	Check for bent, kinked, or dented supply or return	<input type="checkbox"/>
17	Check to make sure fuel tank shipped with a level indicator probe and an inch per gallon laminated fuel level chart.	<input type="checkbox"/>
18	Verify a handle and step is installed on the control panel door.	<input type="checkbox"/>
19	Verify the radiator has been coated with a bronze-glow corrosion resistive coating.	<input type="checkbox"/>
20	Verify the ball valves are installed on the Jacket Water Heater hoses, supply and return.	<input type="checkbox"/>
21	Verify the Jacket Water Heater hose is a silicone type.	<input type="checkbox"/>
22	Ensure that there is an oil vapor recovery box installed.	<input type="checkbox"/>
23	Confirm there is a spill response plan (SPCC) filed and a spill response kit installed on site for tanks larger than 1320 gallons.	<input type="checkbox"/>
24	Check for any threaded connections on tank are touched up with the supplied touch up kit. Any and all exposed uncoated metal should be coated.	<input type="checkbox"/>
25	External Piping is welded stainless steel	<input type="checkbox"/>
26	Verify Greenleaf system interface with SCADA for generator run sequences and fuel level.	<input type="checkbox"/>

# JEA Water and Wastewater Standards 433 Submersible Wastewater Pumping Stations

27	Digital copies of warranties and Manuals	<input type="checkbox"/>
28	Inspect fuel filters for dirt, water, or other foreign matter	<input type="checkbox"/>
29	Check for water in the fuel filter	<input type="checkbox"/>
30	Inspect the entire air-intake system for openings that could draw in unfiltered air	<input type="checkbox"/>
30	Inspect dry element type filters and replace if clogged. Inspect for damaged seams and pleats.	<input type="checkbox"/>

Comments: \_\_\_\_\_

Contractor Rep: \_\_\_\_\_  
*Signature* *Print name*

JEA Inspector: \_\_\_\_\_  
*Signature* *Print name*

JEA O&M Rep: \_\_\_\_\_  
*Signature* *Print name*

Commission Date: \_\_\_\_\_  
*Signature* *Print name*

# JEA Water and Wastewater Standards 433 Submersible Wastewater Pumping Stations

## XVIII.4. JEA FACILITIES FINAL INSPECTION & COMMISSIONING CHECKLIST

Project Name: \_\_\_\_\_

Street/Intersection/Address: \_\_\_\_\_  
 \_\_\_\_\_

		Checked
1	Fence installed with approved materials in the manner specified	<input type="checkbox"/>
2	Fence installed free of any large gaps (those greater than 6 in.) at sides/corners	<input type="checkbox"/>
3	Fence installed with maximum clearance of 6 in. above finished grade	<input type="checkbox"/>
4	Fence installed with a minimum 12 in. mow strip, with galvanized anchors every 3-5 ft.	<input type="checkbox"/>
5	Maximum fence post span 10 ft. or less	<input type="checkbox"/>
6	Fence at least 6 ft. high, chain-link mesh (9 gauge minimum) with 3 strands of barbed wire extended outwards from top of fence at a 45-degree angle with the smooth side of the fence on the outside wall. Materials approved by Security and Facilities.	<input type="checkbox"/>
7	Inspect fence posts and fabric for correct material (vinyl coated black or green)	<input type="checkbox"/>
8	Gate installed with approved materials in the manner specified	<input type="checkbox"/>
9	Gate installed free of any large gaps at sides	<input type="checkbox"/>
10	Gate installed with maximum clearance of 6 in. above finished grade	<input type="checkbox"/>
11	Gate has an adequate catch to ensure the gate cannot be pushed in or pulled out	<input type="checkbox"/>
12	Gate installed with minimum height 72 in. for fence fabric (usually chain link), plus 3 strands of barbed wire, or using fabric/material with a minimum height of 96 in.	<input type="checkbox"/>
13	Gate operates smooth and freely, without stress on gate operator	<input type="checkbox"/>
14	Operator appears to be adequately anchored	<input type="checkbox"/>
15	Operator is the unit specified	<input type="checkbox"/>
16	Exit/Safety loops installed at required distances and function properly	<input type="checkbox"/>
17	Limit switches appear to be set appropriately	<input type="checkbox"/>
18	Inspect asphalt; check slope for proper drainage (no puddles)	<input type="checkbox"/>
19	Card readers are appropriate models, installed appropriately, and function correctly	<input type="checkbox"/>
20	Storm drain gates clean and open	<input type="checkbox"/>
21	Ensure that all debris has been removed from the site	<input type="checkbox"/>
22	Ensure that all required signage has been installed (incl. Pump Station I.D. sign)	<input type="checkbox"/>
23	Fire hydrant as specified and operating (if applicable)	<input type="checkbox"/>
24	All landscaping is to JEA standards	<input type="checkbox"/>
25	Irrigation is installed and functions properly (Establishment Only)	<input type="checkbox"/>
26	Copy of Backflow Certification sent Building Ops	<input type="checkbox"/>

***JEA Water and Wastewater Standards  
433 Submersible Wastewater Pumping Stations***

Comments:

Contractor Rep:

---

JEA Inspector:

*Signature*

*Print name*

---

JEA O&M Rep:

*Signature*

*Print name*

---

Commission Date:

*Signature*

*Print name*

---

*Signature*

*Print name*

---

---

# JEA Water and Wastewater Standards 433 Submersible Wastewater Pumping Stations

## XVIII.5. JEA ELECTRICAL PRE-COMMISSIONING CHECKLIST

Project Name: \_\_\_\_\_  
 Street/Intersection/Address: \_\_\_\_\_  
 \_\_\_\_\_

		Checked
1	Check that all defects from switchboard inspection have been addressed	<input type="checkbox"/>
2	Electricity supply has been connected and energized. Certificate of Compliance for Electrical Work (CCEW) and associated paperwork has been supplied	<input type="checkbox"/>
3	Pump with the lowest serial number is installed as Pump 1 (i.e. nearest to switchboard)	<input type="checkbox"/>
4	Specified pump number labels are correctly installed adjacent to the pumps	<input type="checkbox"/>
5	"DANGER ELECTRIC" marker bricks installed at ground level and painted yellow	<input type="checkbox"/>
6	Earth electrode installed as specified	<input type="checkbox"/>
7	Earth pit, main earth electrode and water service bond installed	<input type="checkbox"/>
8	Meter panels are equipped and wired to requirements	<input type="checkbox"/>
9	Cable supports within the pump well are correctly located and properly fixed	<input type="checkbox"/>
10	No cable stocking has more than one cable installed in it	<input type="checkbox"/>
11	Motor cables are supported so as to avoid damage when removing other pump/pumps	<input type="checkbox"/>
12	Motor cables have minimal slack and do not present undue stress on motor cable glands	<input type="checkbox"/>
13	Check that the cable duct cover is held firmly under the edge of the concrete plinth by the well sliding cover. Also, check that it is held firmly under the edge at the switchboard end.	<input type="checkbox"/>
14	Appropriate lugs fitted to all field cables, and cables correctly identified at terminations	<input type="checkbox"/>
15	Confirm sufficient terminals installed for an individual terminal for every incoming field wire	<input type="checkbox"/>
16	Confirm all field wiring holes are mechanically protected (bushes, sleeves, etc.)	<input type="checkbox"/>
17	Motor terminations are in accordance with the connection diagram	<input type="checkbox"/>
18	All power cable terminations tested for tightness	<input type="checkbox"/>
19	Where parallel cables may be installed on site, provision has been made to ensure only one cable lug needs to be installed on each side of terminal lug	<input type="checkbox"/>
20	SCA rating plate complying with AS 3439 has been fixed	<input type="checkbox"/>
21	Confirm motor and pump details displayed on all labels are identical to the manufacturer's information. Take a copy of name plate information	<input type="checkbox"/>
22	Correct orientation and fixing of the switchboard as per design	<input type="checkbox"/>
23	Switchboard plinth and all gland plates sealed	<input type="checkbox"/>
24	<u>Check continuity of Earthing system:</u>	
	Main Earth	<input type="checkbox"/>
	Water pipe bond	<input type="checkbox"/>



## JEA Water and Wastewater Standards 433 Submersible Wastewater Pumping Stations

	Pump 1 connection box	<input type="checkbox"/>
	Pump 2 connection box	<input type="checkbox"/>
	Pump 1 Motor	<input type="checkbox"/>
	Pump 2 Motor	<input type="checkbox"/>
25	With the motor circuit breakers open and the control isolators off, tum the main switch on, and check that the supply monitoring relay picks up	<input type="checkbox"/>
26	Check operation of phase failure/phase reversal function of the power meter by removing one phase of supply. Also check by reversing the supply rotation to	<input type="checkbox"/>
27	Measure the voltages both phase to phase and phase to neutral. Compare the actual voltages relative to typical no-load voltage of 400/230V, and the voltage variation between phases should be less than 2%	<input type="checkbox"/>
28	Check settings of Starters(VSD or Soft starter)	<input type="checkbox"/>
29	If fitted, check operation of by-pass contactor	<input type="checkbox"/>
30	Check the motor and pump nameplates for all details and for compliance with the data shown on the pump rating plate. Take a copy of name plate information	<input type="checkbox"/>
31	Check that the level switches have been adjusted to the required settings and are functional	<input type="checkbox"/>
32	Check that level transmitters give an analogue output for the full level range of the device. Simulate a pressure/water level of zero to full (or part of) span and check the reading on the level display	<input type="checkbox"/>
33	For the following tests. test for pump 1 & pump 2:	<b>P1 P2</b>
	E-Stop	
	Overload	
	Motor Thermal Protection	
	Other: Check operation of all safety/protective devices for correct operation	
34	With the main switch, pump circuit breakers and control isolating switches off, conduct an insulation test with a megometer (megger test) on all motors at 500V. This must give greater than 10MΩ.	<input type="checkbox"/>
	Record Results:	
	415 Bus	RW WB BW RE WE
	BE	
	Pump 1 cables	RW WB BW RE WE
	BE	
	Pump 2 cables	RW WB BW RE WE
	BE	
	GPO RE =	
35	For each pump tum the circuit breaker on and with personnel clear of all pumps, momentarily tum the control switch to ON and check for correct. Switch pump circuit breaker off.	<input type="checkbox"/>

## JEA Water and Wastewater Standards 433 Submersible Wastewater Pumping Stations

36	Confirm that the Power Meter is configured for CT's and that the readings on the local display are appropriate.	<input type="checkbox"/>
37	Inspect telemetry and radio supply cable connections for correct polarity	<input type="checkbox"/>
38	Measure telemetry supply voltage and back-up battery voltage (should be 13.6V). Ensure appropriate voltages are detected as per electrical drawings	<input type="checkbox"/>
39	Check for mains voltage rated insulation on data cables where mixed with mains voltage cables	<input type="checkbox"/>
40	Check configuration of the PLC I/O against electrical drawings	<input type="checkbox"/>
41	Confirm that the telemetry unit has been configured	<input type="checkbox"/>
42	Confirm that the RTU calibration certificate has been supplied	<input type="checkbox"/>
43	Visual check of antenna installation, clearance from surroundings, mountings secure, and all cables connectors fitted and taped.	<input type="checkbox"/>
44	Check antenna mounted with weep hole to bottom	<input type="checkbox"/>
45	Check antenna bearing and polarization	<input type="checkbox"/>
46	Check for secure earth on radio coax surge protection (if applicable) and coax continuity	<input type="checkbox"/>
47	Check radio is marked with frequency in use as per electrical drawings	<input type="checkbox"/>
48	Check radio signal strength against fade margin figures	<input type="checkbox"/>
49	Check telemetry transmit-level to network device. Set as required by network device	<input type="checkbox"/>
50	Check telemetry receive level from network device, and set as required by the network device (or if not adjustable, ensure level is below telemetry threshold level)	<input type="checkbox"/>
	Monitor telemetry messages for errors	<input type="checkbox"/>
	Monitor radio audio clarity and set audio control off or to min volume	<input type="checkbox"/>
	Enable SCADA RTU and check telemetry unit is configured correctly	<input type="checkbox"/>
	Check that correct locks are fitted	<input type="checkbox"/>
	Monitor SCADA pull and error counters for satisfactory operation over a period of time until error rate is below 3%	<input type="checkbox"/>

OK

Rework Required

Comments:

---

Contractor Rep:

---

*Signature*

*Print name*

JEA Inspector:

---

*Signature*

*Print name*

JEA O&M Rep:

---

*Signature*

*Print name*

Commission Date:

---

*Signature*

*Print name*

# JEA Water and Wastewater Standards 433 Submersible Wastewater Pumping Stations

## XVIII.6. JEA INSTRUMENTATION COMMISSIONING CHECKLIST

Project Name: \_\_\_\_\_  
 Street/Intersection/Address: \_\_\_\_\_  
 \_\_\_\_\_

		Checked
1	Probe in Oil	<input type="checkbox"/>
2	Normal Switch State	<input type="checkbox"/>
3	Do latches on control panel work smoothly?	<input type="checkbox"/>
4	Are all connections tight?	<input type="checkbox"/>
5	Is the interior of the panel dry?	<input type="checkbox"/>
6	High water alarm light and horn activate with test button?	<input type="checkbox"/>
7	Horn silences with silence button?	<input type="checkbox"/>
8	High water alarm light and horn activate with float?	<input type="checkbox"/>
9	All electrical components are locally available	<input type="checkbox"/>
10	<b>SCADA:</b>	<input type="checkbox"/>
11	Auto control	<input type="checkbox"/>
12	Hand/Manual control	<input type="checkbox"/>
13	Pump 1 status	<input type="checkbox"/>
14	Pump 1 start	<input type="checkbox"/>
15	Pump 2 status	<input type="checkbox"/>
16	Pump 2 start	<input type="checkbox"/>
17	Pump 3 status	<input type="checkbox"/>
18	Pump 3 start	<input type="checkbox"/>
19	Generator run status	<input type="checkbox"/>
20	Power fail	<input type="checkbox"/>
21	Generator fail	<input type="checkbox"/>
22	Battery fail	<input type="checkbox"/>
23	Transducer fail	<input type="checkbox"/>
24	High wet well level alarm	<input type="checkbox"/>
25	Station Intrusion	<input type="checkbox"/>
26	Turn off main switch. On the overview page of the SCADA confirm that the <i>POWER</i> changes from <i>NORMAL</i> to <i>FAIL</i> . And back again when the power is restored	<input type="checkbox"/>
27	For each pump:	Pump 1   Pump 2   Pump 3

## JEA Water and Wastewater Standards 433 Submersible Wastewater Pumping Stations

28	Turn the pump from OFF to HAND. Check on the SCADA that LOCAL HOA changes from OFF to HAND.	<input type="checkbox"/>	<input type="checkbox"/>	<input type="checkbox"/>
29	Turn pump from HAND to AUTO. Check on the SCADA that LOCAL HOA changes from HAND to AUTO. NB: Pump may stop if not called by the controller.	<input type="checkbox"/>	<input type="checkbox"/>	<input type="checkbox"/>
30	Turn pump from AUTO to OFF. Check that LOCAL HOA changes to OFF and PUMP STATUS changes (or already has changed) back to STOP	<input type="checkbox"/>	<input type="checkbox"/>	<input type="checkbox"/>
31	Bridge out terminals for the seal fail probe on the pump until the seal fail relay is activated (may be referred to as "Pump Warning Healthy"). Check on the SCADA that PUMP WARNING changes from NORMAL to ALARM (FAIL) & the "SEAL FAIL" label is ON. Reset the relay and check that PUMP WARNING returns to NORMAL & the "Pump Warning" lamp is OFF. NB: This will not trip the pump.	<input type="checkbox"/>	<input type="checkbox"/>	<input type="checkbox"/>
32	Test operation of overload relay by winding down trip point. Check on the SCADA that the pump becomes unavailable and the pump status is FAILED & the "Drive Fault" lamp is ON. Reset the relay. Reset the alarm condition by switching pump to OFF, then AUTO. Check Alarm clears	<input type="checkbox"/>	<input type="checkbox"/>	<input type="checkbox"/>
33	Using a manual trip on the pump temperature sensor relay (may be referred to as "Pump Protection"). Ensure that the drive trips and becomes unavailable on the SCADA, and check that the "OVER TEMP" label is ON. Remove the trip condition and reset by pump inhibit OR switch pump to Off, then Auto.	<input type="checkbox"/>	<input type="checkbox"/>	<input type="checkbox"/>
34	With pumps running, ensure that the correct current readings are recorded in SCADA.	<input type="checkbox"/>	<input type="checkbox"/>	<input type="checkbox"/>
35	Check on the SCADA that Pump Hours Run is calculated and displayed correctly. NB: Change clock on PLC to test as value resets at 8 am.	<input type="checkbox"/>	<input type="checkbox"/>	<input type="checkbox"/>
36	Check on the SCADA that Pump Starts for the previous hour is calculated and displayed correctly.	<input type="checkbox"/>	<input type="checkbox"/>	<input type="checkbox"/>
37	Ensure that an appropriate "Fail to Start" time has been entered. Remove the Pump Start feedback from PLC and call the pump to run in Auto. After the "Fail to Start" time, ensure that an Alarm is raised, and the pump is FAILED & the "Drive Fault" lamp is ON. Reset the relay. Reset the alarm condition reset by pump inhibit OR switch pump to OFF, then Auto. Check that the pump is no longer FAILED & the "Drive Fault" lamp is OFF.	<input type="checkbox"/>	<input type="checkbox"/>	<input type="checkbox"/>
38	Ensure that an appropriate "Fail to Start" time has been entered. Remove the Pump Start feedback from PLC and call the pump to run in Auto. After the "Fail to Start" time, ensure that an Alarm is raised, and the pump is FAILED & the "Drive Fault" lamp is ON. Reset the relay. Reset the alarm condition reset by pump inhibit OR switch	<input type="checkbox"/>	<input type="checkbox"/>	<input type="checkbox"/>

# JEA Water and Wastewater Standards 433 Submersible Wastewater Pumping Stations

---

pump to OFF, then Auto. Check that the pump is no longer FAILED  
& the "Drive Fault" lamp is OFF.

---

Comments:

---

Contractor Rep:

---

*Signature* *Print name*

JEA Inspector:

---

*Signature* *Print name*

JEA O&M Rep:

---

*Signature* *Print name*

Commission Date:

---

*Signature* *Print name*

---

# JEA Water and Wastewater Standards 433 Submersible Wastewater Pumping Stations

## XVIII.7. JEA PUMP STATION BACK UP POWER DECISION TREES

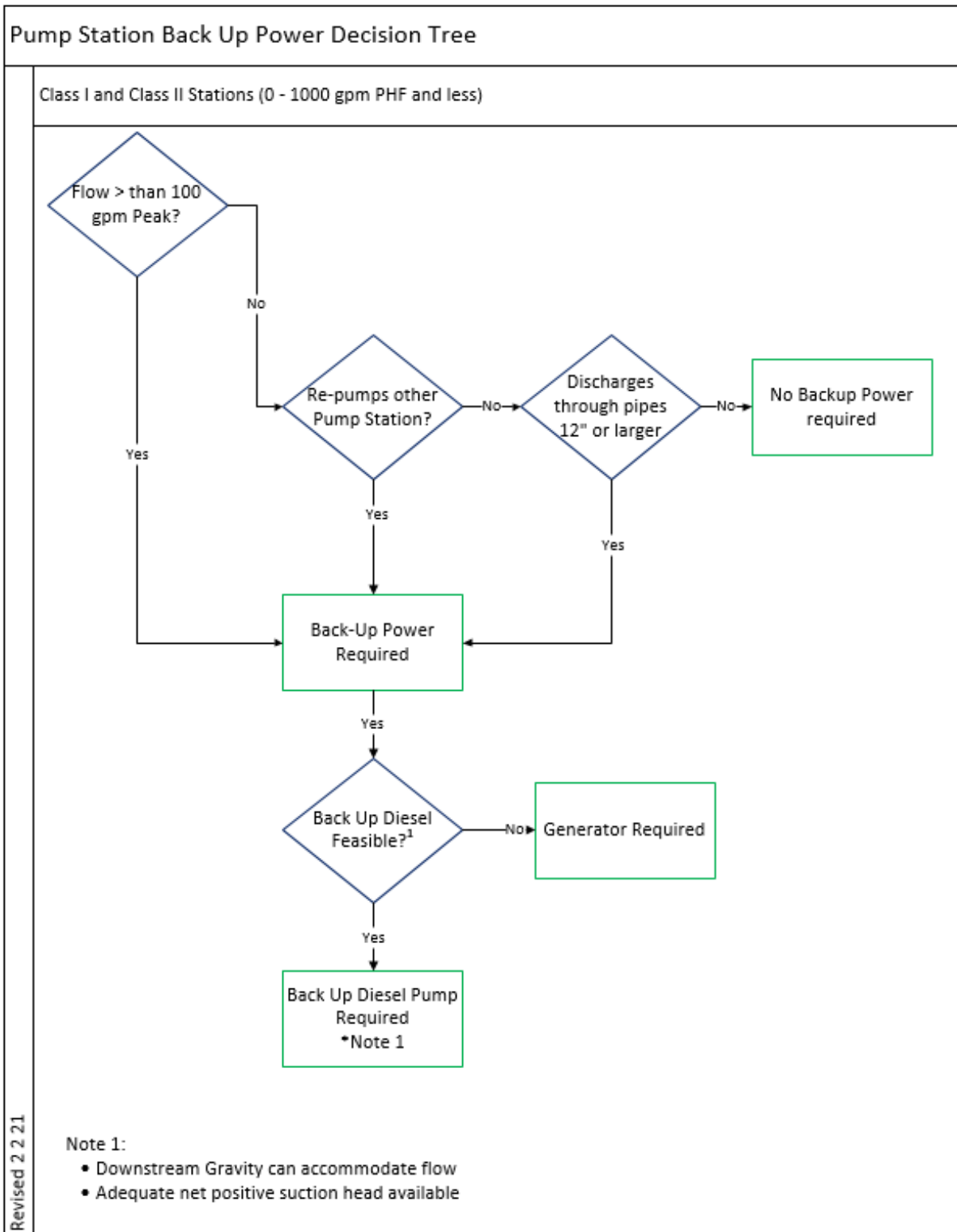

# JEA Water and Wastewater Standards 433 Submersible Wastewater Pumping Stations

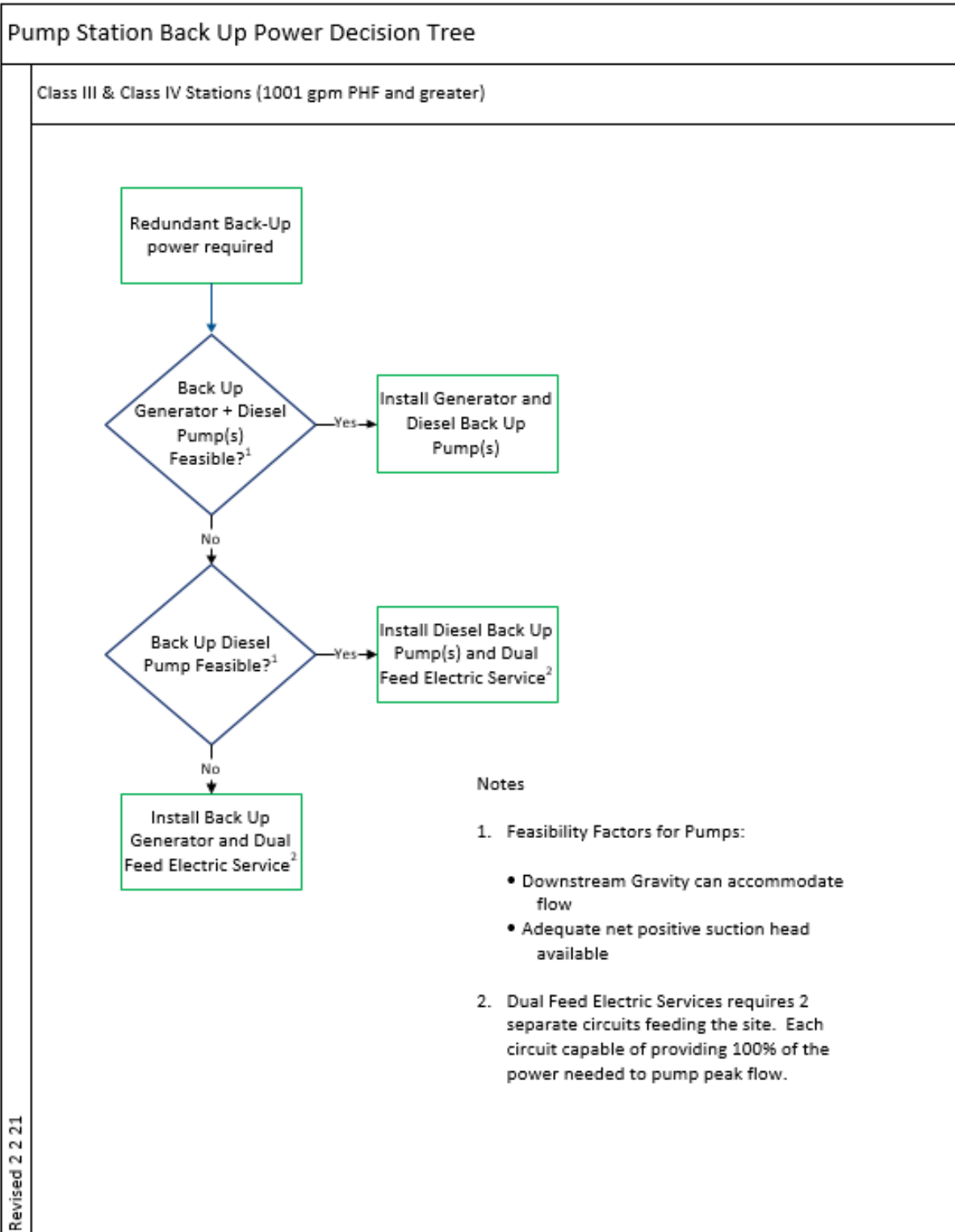

## **435 - BOOSTER WASTEWATER PUMPING STATION**

### **I. GENERAL REQUIREMENTS**

#### **I.1. SCOPE OF WORK**

The Contractor shall furnish, install, test and place in operation the In-line Booster pumping station shown on the drawings and specified hereinafter. All applicable sections of the City of Jacksonville Standard Specifications and JEA Water and Wastewater Standards shall be considered part of this work. All references to Industry Standards (ASTM, ANSI, etc.) shall be to the latest revision unless otherwise stated. Only those materials included in the JEA Water and Wastewater Standards Manual, (including, but not limited to, dry pit pumps, VFD equipment and control panels), shall be installed. All materials shall be new unless specifically called for otherwise. All structures, pumps and panels require a complete shop drawing submittal, as detailed in this specification for JEA's review and approval prior to the start of construction.

#### **I.2. PROJECT SCHEDULE AND COOPERATION**

The project schedule shall be established based on working a normal work schedule including five days per week, single shift, and eight hours per day or four days per week, single shift, ten hours per day. Unless approved otherwise by JEA, normal or general items of work such as setting wet well (base and riser sections), field pump test, density testing and final inspections, shall be scheduled during the normal work schedule. Due to operational and man power limitations on the JEA systems, JEA will require the contractor to perform work outside of the normal work schedule. These operational and manpower limitations, including but not limited to, tie-in work (cut-in work or other work) and other phases of the work which may impact the continued (non-interruptible) service to existing JEA customers. The contractor shall plan and anticipate the cost impact of these systems limitations and provide such work or services at no additional cost to JEA. Unless approved otherwise, a JEA representative shall be present to observe the excavated area prior to setting (installing) the wet well. The date and time for setting (installing), the pre-cast wet well shall be reviewed and approved by JEA, prior to the actual work.

#### **I.3. SHOP DRAWING SUBMITTALS**

Actual catalog data, brochures and descriptive literature will not be required for items of standard usage which meet the requirements of Chapter X. and Chapter XI. of the JEA Water and Wastewater Standards Manual. Any specialty item not shown in this manual will require a complete shop drawing submittal. The Engineer may at any time require the Contractor to provide a complete detailed shop drawing submittal for any material which, in the Engineer's opinion, may not be in compliance with the JEA Water and Wastewater Standards.

Actual catalog data, brochures and descriptive literature will be required for dry pit pumps, electrical and controls at a minimum as specified here-in.

#### **I.4. AS-BUILT DRAWINGS**

As-built drawings shall be required on all Wastewater, force main and pump station projects, including projects for JEA, City of Jacksonville, JTA, DOT, private developments (utilities to be dedicated to JEA), and other City Authorities, etc. As-built drawings shall be in accordance with specification Chapter VI. 1. - Section 501, entitled "As-built Drawings" and as defined here-in. As-built drawings shall be reviewed and approved by JEA. The cost to provide as-built drawings shall be included as part of the related work requirements or general conditions for the utility work. The contractor shall submit "As Built" drawings to



# ***JEA Water and Wastewater Standards 435 Booster Wastewater Pumping Stations***

JEA for JEA Project Manager, Development (if applicable) and JEA O&M for review prior to pump station start-up. JEA will review the pump station "As-Built" during the start-up for accuracy. The "As-Built" drawing comments will be returned to the contractor following the start-up. Once the "As-Built" is finalized and JEA has issued the as-built approval letter, the Certificate of Completion (COC) can be processed.

## **I.5. OPERATION AND MAINTENANCE DATA SUBMISSION**

All pump stations will be required to submit completed and approved equipment attribute worksheets, in JEA's submittal spreadsheet, prior to pump station acceptance. See Chapter IV.7. Pump Station Operation and Maintenance Data Submission Requirements - Section 445.

## **I.6. WARRANTY**

### **I.6.1. CONTRACTOR WARRANTY**

The Contractor shall supply to JEA a two (2) year unconditional warranty effective on the date of the JEA's Operation and Maintenance Pump Station acceptance letter. The warranty shall include materials and installation and shall constitute complete replacement and delivery to the site of materials and installation of same to replace defective materials or defective workmanship with new materials/workmanship conforming to the specifications to insure safe and correct operation of the station.

### **I.6.2. PUMP MANUFACTURER WARRANTY**

The pump manufacturer shall warrant to JEA all permanently installed municipal sewage service submersible pumps and motors against all defects in materials and workmanship including normal wear and tear to the following parts for a period of 5 years: mechanical seals, bearings, shafts, motor electrical cables and motor stators. See below for additional warranty and service requirements.

## **I.7. WORKMANSHIP**

All work shall be proved to be in first class condition and constructed in accordance with the drawings and specifications. All defects disclosed by tests and inspections shall be remedied immediately by the Contractor with no additional cost to JEA.

## **I.8. MATERIALS**

All material shall be free from defects impairing strength and durability and be of the best commercial quality for the purpose specified. The pumps and motors shall be supplied by the pump supplier to ensure unit compatibility.

### **I.8.1. METAL COMPONENTS**

Unless indicated otherwise on the drawings, all metal components, with the exception of pipe, fittings, pumps and motors shall be anodized aluminum or 316 stainless steel as specified here in or on the plans.

### **I.8.2. STATION PIPING**

Station piping shall conform to JEA Water and Wastewater Standards Chapter IV. 3. - Section 429, entitled Wastewater Force Mains and Chapter IV. 4. Section 430, entitled Wastewater Valves and Appurtenances. Specifically, station piping shall be plumbed and aligned according the latest ASTM, AWWA standards, any piping irregularities shall be removed and replaced.

# JEA Water and Wastewater Standards

## 435 Booster Wastewater Pumping Stations

### I.8.2.1. Stainless Steel Piping and Fittings

All piping above grade within the in line booster station site shall be 316 stainless steel: flanged, schedule 40. Butt-welding of any piping (except for the emergency suction pipes, if applicable) is not allowed. All bolts, washers and nuts shall be 316 stainless steel, threaded and shall be coated with "Never Seize" type coating.

I.8.2.1.1. Fittings may be 316 stainless steel flanged type manufactured in accordance with ASTM-A774, AWWA C110 of the same raw material and in the same thicknesses as the pipe.

I.8.2.1.2. The finish on the stainless steel raw material, manufactured to ASTM A-240 will be No. 1, HRAP (hot rolled annealed and pickled) or better. The finish on the completed stainless steel pipe and fittings shall be as specified in ASTM A778 and A774, respectively.

### I.8.2.2. Ductile Iron Fittings

Fittings may also be flanged ductile iron with specialty inside coating.

### I.8.2.3. PVC Piping

Buried piping shall be PVC Dr18. Transition from PVC to stainless steel or ductile iron shall be flange to mechanical joint.

### I.8.2.4. Cam-locks shall be 316 stainless steel.

## I.9. CRITERIA FOR AN IN-LINE BOOSTER WASTEWATER PUMPING STATION

The use of an in-line booster wastewater pumping station is intended to serve areas within the sewer collection systems that have a large basin area and long force mains. Criteria for the selection of an in-line booster station includes a location where all flow is pumped to the site, no influent gravity flow, no system storage available, and a minimum pumping capacity of 2001 gpm. JEA will have the final approval on the use of an in-line booster station.

Pump Station Type	Pump Station Maximum Peak Flow (GPM)	Emergency Operating System Required	Additional Design Requirements
Class IV	2001 GPM and Above	Generator and Emergency Pump Engine(s)**	Flow meter and Smart electric meter, plus Electric power & controls building with ventilation.

\*\* See appendix for emergency backup requirements if emergency pump engine or generator is not feasible

### I.9.1. DEFINITION OF FLOW

I.9.1.1. The Pump Station Maximum Peak flow in GPM (gallons per minute) is the ultimate peak design flow of the pump station using the 10 State Standards peaking factor applied to 3.5 people per Equivalent Dwelling Units (EDU) and 100 GPD per person.

# *JEA Water and Wastewater Standards*

## *435 Booster Wastewater Pumping Stations*

The pump station Maximum Peak Flow GPM excludes the flow from the permanently installed stand-by pump and any emergency standby by pump.

I.9.1.2. The Pump Station Maximum Average Daily Flow (ADF) in GPD (gallons per day) is the station's un-peaked maximum/ultimate average daily flow rate the station will be pumping.

I.9.1.3. The Pump Station Maximum Equivalent Dwelling Units (EDU's) is the ultimate number of Equivalent Dwelling Units the station will be pumping, which equates to 350 GPD per EDU.

### **I.9.2. BACK UP POWER REQUIREMENTS**

I.9.2.1. An emergency operating system shall be required for all pump stations. The emergency operating system shall be a Generator receptacle, an Emergency Generator (see section 472, Emergency Generator), an Emergency Pump Engine (see section 470, Emergency Pump Engine) and (if emergency pump engines are not feasible) Dual Feed electric service.

I.9.2.2. Refer to Chapter IV. 7. - Section 472, "Emergency Generator", for technical specifications on automatic standby emergency generator with diesel engine drive and above ground fuel storage tank. All generators shall be sized to run all pumps at station.

I.9.2.3. Refer to Chapter IV.6 – Section 407, "Emergency Pump Engines", for technical specifications on standby emergency pump engine with fuel storage tank. All emergency pump engines shall be sized to run all pumps at station.

I.9.2.4. Reference Appendix for Back Up Power Decision Matrix.

I.9.2.5. All pumping station emergency back-up systems, separate or combined, are to be sized to peak flow.

### **I.9.3. SMART METER**

All pumping stations shall have a Smart meter to monitor electrical conductivity. The electrical provider shall supply the meter.

### **I.9.4. FLOW METER**

Class, II, III and IV pumping stations, both rehabilitation and new construction, shall include a magnetic flow meter (indicating, totalizing, data transmission via SCADA and recording capabilities). Magnetic flow meters shall have a by-pass configuration located within the fenced area.

### **I.9.5. ELECTRICAL CONTROL BUILDING**

For stations with more than 3 pumps and/or with motors larger than 75 HP and/or have a full load amperage of greater than or equal to 400 amps, an electric power and control building shall be provided in accordance with in accordance with the Submersible Wastewater Pumping Station – Section 433, VII, Prefabricated Concrete Enclosure standards. Control building required if any of the below conditions exists:

- Pumps larger than 75 hp

# *JEA Water and Wastewater Standards*

## *435 Booster Wastewater Pumping Stations*

- Station FLA > 400 amps
- Station has > 3 pumps

### **I.10. PUMP STATION FINAL INSPECTION**

Contractor shall schedule a final walk through (prior to substantial completion) in order to create a punch list for each project. List of attendees shall include but not be limited to the Contractor's representative, JEA representative (i.e. project inspector), and designated JEA Operation (i.e. O&M mechanical) personnel. Contractor shall be required to provide a crew complete with all necessary equipment to allow observation of each station. The Contractor's representative shall complete the Inspection Checklists in this specification section for each new or rehabilitated pump station, and have the JEA attendees provide original signatures/names on the signature blocks.

## **II. DRY PIT PUMPS**

### **II.1. GENERAL**

Equipment furnished and installed shall be fabricated, assembled, erected and placed in proper operating condition in full accordance with drawings, specifications, engineering data, instructions and recommendations of the equipment manufacturer, unless exceptions are noted and approved by JEA.

### **II.2. PUMP OPERATING CONDITIONS**

II.2.1. Pump performance shall be stable and free from cavitation and noise throughout the specified operating head range at minimum suction submergence. Pump shall be designed so that reverse rotation at rated head will not cause damage to any component.

II.2.2. Operating conditions and unit sizes shall be as shown on the drawings. Pump shut-off head shall be a minimum of 15% greater than the pump design head for the "all pumps on" condition, such that a pump with a design point of 500-GPM at 100-FT-TDH must provide a shut-off head greater than 115-FT-TDH. JEA will provide collection system pressure information to aid in the design and selection of the pumps.

### **II.3. SHOP DRAWINGS AND PUMP TAGS**

Prior to commencing the pumping station installation and/or the furnishing of replacement pumps, the pump distributor shall submit for approval, detailed and dimensioned shop drawings for pumps including factory curves of identical model pumps provided to JEA. The pump distributor shall furnish and deliver at the time of acceptance for use of the pumping station and/or of the replacement pump(s) by JEA, 3 computer diskettes (Microsoft Word) containing Operation & Maintenance data and motor and pump nameplate data (including serial numbers) for each pump supplied. The pump supplier shall provide a vinyl or aluminum placard or tag which indicates all operating conditions of the pumps, including name plate data, impeller size and part number, design flow, TDH, and other pump related data. The tag shall be placed (with adhesive) inside the front panel of the pump control panel or as directed by JEA.

### **II.4. PUMP EQUIPMENT**

Pumping equipment shall be as listed in AS-603 and premium quality dry well non-clog pumps for sewage service. Pumps shall be as listed in the JEA Standards Approved Materials section. Dry-pit pumps shall be complete with a submersible electric motor, electric cable (min. cable length to be site specific, dependent upon junction box location(s), maintenance free cooling system, pump support legs and all other appurtenances specified or otherwise required for proper operation. Major pump components shall be of

# *JEA Water and Wastewater Standards*

## *435 Booster Wastewater Pumping Stations*

gray cast iron. All exposed nuts, bolts, washers, anchor bolts and other fastening devices coming in contact with sewage shall be 316 stainless steel.

### **II.5. SOLID HANDLING PUMP CONSTRUCTION (DRY-PIT PUMPS)**

#### **II.5.1. IMPELLER**

The impeller casing shall have well-rounded water passages and smooth interior surfaces free from cracks, porosity, blowholes, or other irregularities. The impeller shall be a semi-open or enclosed one-piece casting with not more than two non-clog passages and must pass a minimum 3 inch solid. Screw impellers are not acceptable. The interior water passages shall have uniform sections and smooth surfaces and shall be free from cracks and porosity. The impeller shall be dynamically balanced and securely locked to the shaft by means of a key and self-locking bolt or nut.

#### **II.5.2. MECHANICAL SEALS (UPPER AND LOWER SEALS)**

Pumps shall have mechanical seals, which shall require neither maintenance nor adjustment and shall be readily accessible for inspection and replacement. The seals shall not rely upon the pumped media for lubrication and shall not be damaged if the pump is run un-submerged for extended periods while pumping under load. Mechanical seals shall be solid hard faced, (not laminated type). The bottom seal shall be tungsten carbide or silicon carbide material. The top seal may be either carbon-ceramic, tungsten carbide or silicon carbide material. Adjustable wearing rings shall be provided for all pumps 25 HP and larger.

#### **II.5.3. MATING SURFACES**

All mating surfaces (pump assembly), of major components shall be machined and fitted with O-rings where watertight sealing is required.

#### **II.5.4. MOTORS**

The pump shall be driven by a totally submersible electric motor at 1800 RPM (max.). Pump motor shall be of sufficient horsepower as to be non-overloading over the entire length of the pump curve. The stator housing shall be a watertight casing. Motor insulation shall be moisture resistant, Class F, 180 degree C. at a minimum. All motors shall be VFD rated including class H winding insulation. Motor shall be NEMA Design B for continuous duty at 40 degree C ambient temperature and designed for at least 10 starts per hour. All motors over 3 HP shall be 3 phase. Motor bearings shall be anti-friction, permanently lubricated type. Motor shall be designed to operate in a totally, partially or non-submerged condition without damage to the motor. Pump cable assembly shall bear a permanently embossed code or legend indicating the cable is suitable for submerged use. Cable sizing shall conform to NEC requirements. The cable shall enter the pump(s) through a heavy-duty stainless steel assembly with grommet. An epoxy seal may be added to this cable entrance assembly to improve water tightness. The system used shall ensure a watertight submersible seal. Cable shall terminate in a junction chamber. Junction chamber shall be sealed from the motor by a compression seal.

#### **II.5.5. COOLING SYSTEM AND SUPPORTS (DRY-PIT APPLICATIONS ONLY):**

The pump should have a reliable, maintenance free cooling system that circulates a cooling liquid in a closed loop through a cooling jacket, and transfers the heat to the pumped liquid by heat exchange. A system that circulates the pumped liquid in a cooling system is not acceptable. The pump should be equipped with support base to secure the pump and facilitate the installation.

# *JEA Water and Wastewater Standards*

## *435 Booster Wastewater Pumping Stations*

### **II.5.6. ROTATING PARTS**

All rotating parts shall be accurately machined and shall be rotational balance. Excessive vibration shall be sufficient cause for rejection of the equipment. The pump impellers shall be re-balanced after being trimmed.

### **II.5.7. PAINTING**

Exterior of pump shall be coated with manufacturer's standard finish (powder coated epoxy finish is preferred, not required).

### **II.5.8. INSTALLATION**

Pump discharge base shall be leveled, plumbed and aligned into position to fit connecting piping. The discharge base shall be solidly secured to the booster station concrete base using a 1" thick steel hold-down plate (see details) and appropriately sized 316 stainless steel anchors then grouted after initial fitting and alignment and before final bolting of the discharge piping. This work shall be inspected by JEA prior to any liquid being allowed to pump. After final alignment and bolting, pump discharge base and all connections shall be inspected. If any movement or opening of any joints is observed, any and all piping, including pump discharge base, shall be corrected.

## **II.6. PUMP WARRANTY (SOLIDS HANDLING)**

The following warranty conditions shall also apply to existing pump station pump replacements.

II.6.1. The manufacturer shall warrant to JEA for the permanent installation in municipal sewage service, the submersible/dry pit pump and motor against defects in materials and workmanship including normal wear and tear to the following parts for a period of 5 years, mechanical seals, bearings, shafts, motor electrical cables and motor stators. The warranty shall include no less than 100% coverage for original equipment (OEM) parts and in-shop labor for pump/motor repairs for the full 5 years at NO COST to JEA. This warranty shall not apply to parts that fail due to abuse, neglect, mishandling, or acts of God. The warranty period shall commence upon the date of final acceptance for use the pumping station and/or of the replacement pump by JEA.

II.6.2. Verification of guarantees of performance and warranty certificate shall be indicated in the shop drawing submittal and in the Operation and Maintenance disc.

II.6.3. The pump distributor shall employ and make available proficient manufacturer-authorized service technicians to perform service calls to pumps supplied to JEA on a 24 hour basis, 7 days a week. The pump distributor shall provide service technicians company-owned service vehicles equipped with lifts/booms capable of retrieving all sizes of dry pit pumps from the in-line booster site locations, all necessary tools, test and safety equipment, etc., that are required to make field repairs. Service personnel shall adhere to all JEA Safety Rules & Regulations and be trained and certified for confined space entries and carry liability and workers compensation insurance.

II.6.4. During the warranty period, the pump distributor shall at no cost to JEA repair and re-install the subject pump within 24 hours or provide a loaner pumps which can be transported, installed, and capable of maintaining operation of JEA's sites. The location address, contact names, phone numbers, (including emergency, mobile, etc.) and fax numbers of the manufacturer-authorized warehouse and service center shall be indicated in the shop drawing submittal and in the Operation & Maintenance disc.

## **III. PUMP STATION ELECTRICAL**

# *JEA Water and Wastewater Standards*

## *435 Booster Wastewater Pumping Stations*

### III.1. ELECTRICAL SERVICE

The Contractor shall provide complete new electrical service for each lift station, including coordination of electrical service selection and approval by JEA and the serving electrical utility company. Each lift station electrical service shall include complete primary and secondary electrical service equipment, metering and installation in accordance with these standards and the serving electrical utility company requirements. Unless specifically unavailable from the serving electrical utility company, the electrical service to each lift station shall be three phase. The basis of design lift station electrical service to be requested from the serving electrical utility company shall be as follows:

- III.1.1. 20 HP and below: 240/120 volt, 3-phase, open delta, full voltage motor starting, 15 starts per hour for 1800.rpm pumps.
- III.1.2. 21 HP thru 40 HP: 480/277 volt, 3-phase, wye, full voltage motor starting, 15 starts per hour for 1800 rpm pumps
- III.1.3. 41 HP and above: 480/277 volt, 3-phase, wye, reduced voltage motor starting, 10 15 starts per hour for 1800 rpm pumps
- III.1.4. The lift station design engineer shall contact the serving electrical utility company and obtain written documentation of the availability of the service requested. The electrical service documentation to be obtained from the serving electrical utility company shall identify each of the following basis of design issues:
  - Electrical service voltage and phase
  - Electrical service point of connection
  - Type of motor starting required (full voltage or reduced voltage)
  - Maximum number of starts per hour permitted
  - Maximum available fault current
- III.1.5. The electrical service documentation obtained from the serving electrical utility company shall identify all applicable electrical utility company rules, regulations and fees. Additionally, the lift station electrical design engineer shall obtain a schedule that identifies when the requested electrical service would be available from the electrical utility company.
- III.1.6. If it is determined that the requested electrical service is not available from the electrical utility company, the design engineer shall submit an alternate basis of design recommendation for review and approval by JEA before proceeding with the lift station electrical design.
- III.1.7. The use of 208/120 volt, 3-phase, wye service shall not be permitted. For locations where the serving electrical utility company can only provide 3-phase wye services, the lift station electrical service shall be 480/277 volt, 3-phase, wye. For locations where the serving electrical utility company can only provide 240/120 volt single phase service, the pump motors shall be limited to a maximum of 7.5 HP. Three phase pump motors shall be provided. Variable frequency drive motor starters shall be used to operate the three phase motors from the single phase electrical service.
- III.1.8. Electrical service size shall be based on these standards and N.E.C. requirements. The minimum electrical service size shall be 200 amps. Where the electrical service requirements exceed 200

# *JEA Water and Wastewater Standards*

## *435 Booster Wastewater Pumping Stations*

amps, but are less than or equal to 400 amps, the electrical service size shall be 400 amps. Above 400 amps, the electrical service size shall be selected by the lift station electrical design engineer.

### **III.2. CONTROLS SELECTION GUIDE**

Below is a selection guide to determine the type of panel required for a Booster Station.

- Variable Frequency Drives (VFD)
- A Cross Line contactors (ACL)

III.2.1.1. 0-7.5HP, 1P to 3P VFD Duplex only, Panel is to be sized for no AC.

III.2.1.2. 0-20HP, ACL, 240VAC Service, if larger than 20HP service shall be upgraded to 480VAC.

III.2.1.3. 0-40HP, ACL, 480VAC Service

III.2.1.4. 41-75HP or FLA < 400A, VFD, 480VAC, Panel is to be sized for no AC and Heat sinks vented out the back.

III.2.1.5. 76-200HP or FLA  $\geq$  400A or > 3 Pumps, VFD, in a building. Please contact JEA for further details.

Note that 208VAC shall not be permitted

### **III.3. ELECTRICAL EQUIPMENT**

#### **III.3.1. GENERAL**

The electrical control panel shall only be manufactured by a JEA approved manufacturer as listed in JEA's Approved Materials Manual. JEA Standards approved control manufacturers shall provide shop UL Certification for all control panels prior to JEA site delivery.

#### **III.3.2. DRAWINGS**

Drawings are provided for Across the Line and Variable Frequency Drive designs on the JEA web site. All panels shall be built based on the latest drawings. These drawings are a template of how the overall Control Panel is to be designed. Note the drawings will need to be changed based on the voltage, pump size and the number of pumps. Keep existing format of drawings and only change Title Block.

III.3.2.1. Prior to building all drawings shall be modified and submitted for approval in AutoCAD 2007 DWG format and PDF for review by JEA.

III.3.2.2. Variables for the Across the Line design are wire size, enclosure size, main surge suppression, circuit breaker, contactor size, SIMOCODE volt/current module rating and generator disconnect switch.

III.3.2.3. Variables for the VFD design are wire size, enclosure size, circuit breaker, VFD, reactors and generator disconnect switch.

III.3.2.4. A Control Panel Detail List shall be provided for quotation and design purposes. List will include items as the voltage and FLA. Included shall be detail additional inputs if



# ***JEA Water and Wastewater Standards***

## ***435 Booster Wastewater Pumping Stations***

required for such items as generator monitoring, odor control, potable water presser and other inputs.

III.3.2.5. Key electrical drawings as power distribution and I/O shall be laminated, attached to the door and in color. Drawings shall be printed on 8.5 x 11, if 11 x 17 is too large to fit on the door.

III.3.2.6. Full set of electrical drawings printed with a laser printer and in color shall be inserted in the door pocket. Ink jet is not accepted.

### **III.3.3. PANEL ENCLOSURES**

III.3.3.1. All enclosures and heat shields shall be powder coated white. Before powder coating enclosures they shall be degreased, cleaned and treated with phosphate process.

III.3.3.2. All insides of the enclosures shall be Rated NEMA 12/3R with no ventilation to the outside.

III.3.3.3. All enclosures shall be fitted with 3-point latch.

III.3.3.4. All enclosures shall have marine grade aluminum heat shields on the top, front, back and side, unless mounted inside a building. They shall be fabricated from .125 marine grade aluminum.

III.3.3.5. Enclosures shall have pockets mounted on the inside of the door.

III.3.3.6. The enclosure shall have a twelve gauge steel, formed, removable sub panel. The sub panel shall be degreased, cleaned, treated with phosphate process, then primed and painted with white industrial grade baked enamel.

III.3.3.7. The maximum size of an aluminum enclosure shall be no taller than 60" high or 60" wide with 12" floor stands for a total height of 60". Any enclosure that requires a larger size shall use 316 stainless steel. These enclosures shall be fabricated from .125 marine grade aluminum.

III.3.3.8. Aluminum enclosures with free standing bases shall have the bases manufactured out of 316 stainless steel.

### **III.3.4. ACL CABINET REQUIREMENTS**

The minimum size of an enclosure shall be 42" height x 42" wide x 10" deep with a 36" wide door. These enclosures shall be mounted on poles. If panel requires a larger than 42 x 42 x 10 enclosure, a floor standing enclosure with 12" floor stands with an enclosure height of 48" shall be used. Enclosure total height 60"

### **III.3.5. 1 PHASE TO 3 PHASE VFD CABINET REQUIREMENTS**

Minimum enclosure size for 1P to 3P VFD cabinets shall be 48" high by 36" wide by 16" deep. These enclosures shall be fabricated from .125 marine grade aluminum. Enclosure shall be mounted on 12" floor stands. Enclosure shall be sized to accommodate the heat load without air conditioning. Refer to heat load calculations section of this document to size panel correctly. Above panel does not require heat sinks to protrude from rear.

# *JEA Water and Wastewater Standards*

## *435 Booster Wastewater Pumping Stations*

### III.3.6. 3 PHASE VFD CABINET REQUIREMENTS

- III.3.6.1. Minimum enclosure size for a 40HP VFD cabinets shall be 60" high by 48" wide and 20" deep on 12" floor stands. The maximum enclosure height shall not exceed 72". The sides of the enclosure may be extended no more than three inches from the door. Refer to heat load calculations section of this document to size panel.
- III.3.6.2. VFD's installed in an enclosure outside will be built in a NEMA 12/3R enclosure with the drives heat sinks vented. Refer to drawings for further details.
- III.3.6.3. VFDs shall be bolted to a removable plate that will then be connected to the back of the enclosure with a gasket. The back of the enclosure shall have studs to attach the plate to. This plate is to be adequately designed to support the VFD. Enclosure cutout shall be sized a minimum of 2.75" wider and 3.5" higher on each side of the manufacturer recommended cutout for 40HP VFDs. This will result in a cutout that is no less than 5.5" wider and 7" higher than the manufacturer's specification. Additionally this distance will increase proportionately with the size of the VFD. For example: 80HP VFDs require a cutout that is 5.5" wider and 7.0" higher on each side (a total of 11" wider and 14" higher) of the manufacturer specified cutout. This requirement is to ensure that a future replacement of a VFD will allow for different VFD dimensions.
- III.3.6.4. The rear sunshield shall have a removable cover with handles to allow access to the VFD heat sinks for cleaning and maintenance. The heat shield will have studs sticking out with wing nuts for the removable cover.

### III.3.7. COMPONENTS

Components to build a control cabinet are classified as sole sourced or non-sole sourced as listed below.

- III.3.7.1. Sole sourced items are items in the drawing's bill of material that shall not be substituted. These items are the radio, PLC, input/output modules, communication module, intelligent motor controls, UPS and 4-20ma surge suppression.
- III.3.7.2. Non-sole sourced items such as power supply, transformer, circuit protection and others may be substituted for an equivalent device. The specifications of the devices shall meet or exceed the items listed in the bill of material. Any items found to not meet specification must be replaced at the panel builder's expense.

### III.3.8. WIRING

- III.3.8.1. All wire colors in the panel shall follow the UL508A standards.
- III.3.8.2. Wire type #12 AWG and smaller shall be hook-up/lead tinned copper, # 18 AWG stranded is minimum: 35612 hook-Up lead-UL AWM Style 3173-XL-DUR.
- III.3.8.3. Control  
All control cabinet wiring to the PLC and control devices shall be 18 AWG and terminated with ferrules. Control wiring shall be numbered/lettered at each end. Wire

# *JEA Water and Wastewater Standards*

## *435 Booster Wastewater Pumping Stations*

numbers/letters shall be flattened polyolefin heat shrink markers for permanent wire and cable identification.

### III.3.8.4. Power Wiring

Ampacity rating shall be a maximum of 75C. All wires going from distribution block to the pump breaker and motor contactor shall be sized for 140% of Motors FLA.

### III.3.8.5. Field Wiring

III.3.8.5.1. All field wiring shall be ground burial rated.

III.3.8.5.2. All control wires shall be tin plated and #12 AWG with dielectric grease applied to both ends to prevent corrosion.

III.3.8.5.3. All control wires shall be labeled at both ends for tracing.

III.3.8.5.4. Analog wires shall tin plated with a foil and braided shield.

III.3.8.5.5. VFD rated cable shall be used from the VFD to the demarcation box.

III.3.8.5.6. Field wiring colors:

Motor Wires	240V = Blue, Orange, Black 480V = Brown, Orange, Yellow
Over Temperature	Hot = Black Common = White
Seal Fail	Hot = Red: Common = Orange Ground = Green
High Well	Hot = Blue Common = White/Blue Stripe

### III.3.9. TERMINALS

The minimum size shall be 4 mm. The spring portion of the clamp shall be fabricated of a chrome nickel spring steel of high tensile strength and shall be solid, without perforation. The chrome nickel spring steel spring tension mechanism shall provide the installer the opportunity to directly insert solid or ferruled conductors without having to utilize tooling to open the clamping mechanism. The terminal block shall be designed to accept solid and/or stranded copper conductors without requiring special preparation, such as crimps, ferrules or tinning. Proportional clamping shall ensure mechanical and electrical connection integrity without damage to the conductors of various sizes throughout the rated range. The design of the terminal block shall not prevent or interfere with the use of wire preparation methods, such as crimps, ferrules or tinning. The pullout force shall be a minimum of 6 times that specified in VDE 0611 (Resistance to Vibration Test for Terminal Block). The current bar and clamping yoke shall have traverse grooves to increase the force required for conductor pull out and "Gas tight" connection. The voltage drop also shall remain virtually unchanged. Gas tightness will be per DIN 41640, part 76.

### III.3.10. MANUAL TRANSFER SWITCH

# *JEA Water and Wastewater Standards*

## *435 Booster Wastewater Pumping Stations*

A NEMA 3R enclosed manual transfer switch shall be supplied if a generator set is not installed on-site. The Manual Transfer Switch (200 or 400) amps shall be equal to or greater than current rating of the main breaker.

### **III.3.11. ACROSS THE LINE STARTER SPECIFICATIONS**

#### **III.3.11.1. Intelligent Motor Control**

Across the Line Starter shall be controlled by an intelligent motor control. The motor control shall consist of 4 discrete inputs and 2 discrete outputs. Display interface shall display Warnings, Faults + History, Operational data such as Line Voltage, Current, Power and I/O Status. The display will also have the ability to control from the keypad and switch the modes from Hand, Off, Auto and Override. Profibus DP interface built into the device. This will allow JEA to read and write to all parameters inside the device and to program the device remotely.

III.3.11.2. Decoupling modules shall be required on all non-Wye power systems such as a Delta.

III.3.11.3. Voltage/Current modules shall be sized based on Motor's FLA.

#### **III.3.11.4. Contactors**

III.3.11.4.1. All contactors shall be NEMA rated.

III.3.11.4.2. Device shall be manufactured and tested as a NEMA device; IEC equivalent will not be accepted

III.3.11.4.3. Minimum size contactor shall be NEMA Size 1.

III.3.11.4.4. Fractional size contactors shall not be acceptable.

III.3.11.4.5. Contactors shall be equipped with double break

#### **III.3.11.5. Thermal Magnetic Circuit Breakers**

Thermal magnetic circuit breakers shall be used for the main, emergency and pumps. As a minimum, the breakers must comply with the standards as follows.

III.3.11.5.1. Circuit breakers shall be minimum "E" frame.

III.3.11.5.2. "E" frame circuit breakers shall contain a self-test "Trip Selector" permitting a mechanical simulation of the over current tripping device.

III.3.11.5.3. Protector operators shall be quick make, quick break and trip free.

III.3.11.5.4. Shall be rated a minimum of a 460 Volt @ 14 KAIC for 240 Volt systems and 600 Volt @ 18KAIC for 460/480 Volt systems.

III.3.11.5.5. The thermal and magnetic elements shall operate independently and multiple pole breakers shall be designed with common trip bar breaking all poles when a fault is received on any pole.

## *JEA Water and Wastewater Standards 435 Booster Wastewater Pumping Stations*

### III.3.11.6. Main and Emergency Breakers

III.3.11.6.1. The electric utility company servicing the utility shall provide the maximum available fault current rating for each electrical service. Each panel shall be UL rated for the maximum available fault current.

III.3.11.6.2. The trip rating or setting shall be calculated by taking the largest pump breaker's amps + the nameplate amps of all the other pumps + 10 amps (auxiliary loads) = Normal Main Breaker Trip Setting.

III.3.11.6.3. The minimum size breaker will be 200 amps. Where the breakers trip setting is greater than 200 amps and less than or equal to 400 amps the breakers shall be rated at 400 amps. Where the breakers trip setting is greater than 400 amps the main breaker shall be rated as determined by the lift station electrical design engineer.

### III.3.11.7. Across The Line Pump Breakers

The trip rating or setting shall be calculated using the pump motor nameplate amps x 200% for Across the Line Starters.

### III.3.12. VARIABLE FREQUENCY DRIVE BREAKERS

Breakers shall be selected and sized for maximum ratings per manufacturer's recommendation.

# JEA Water and Wastewater Standards 435 Booster Wastewater Pumping Stations

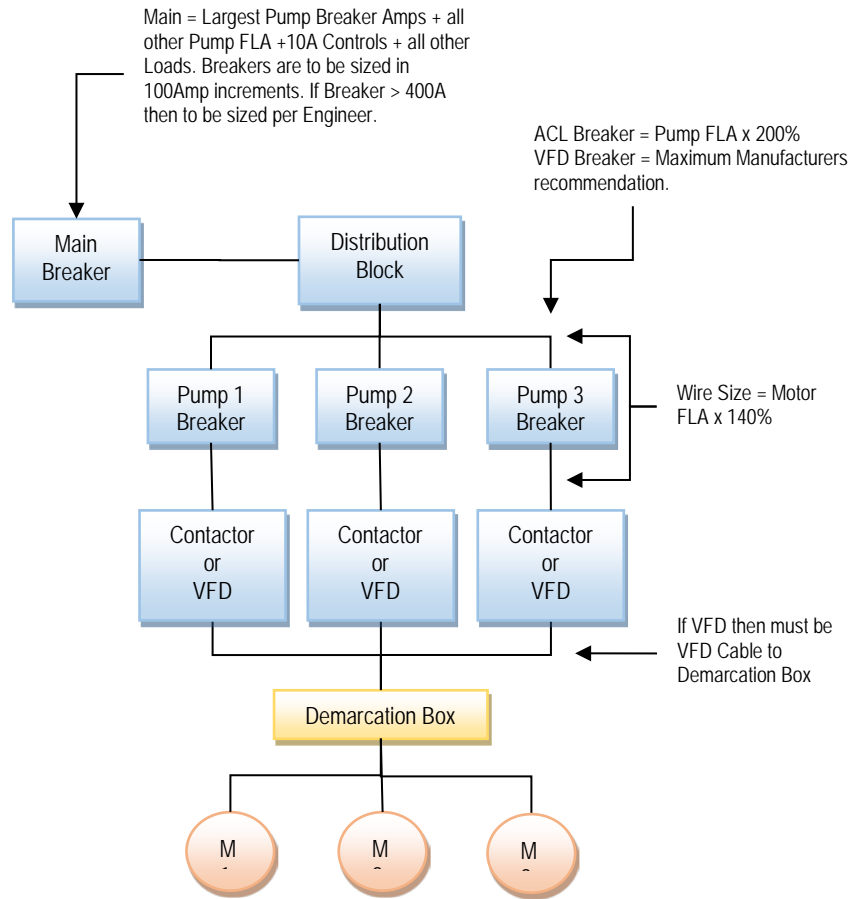

### III.3.13. VARIABLE FREQUENCY DRIVE SPECIFICATIONS

- III.3.13.1. Reference Section 495 Variable Frequency Drive Specifications for full details.
- III.3.13.2. All VFD's shall come pre-programmed to the description of the VFD Float Backup Functional as described below.
- III.3.13.3. All drawings shall come with a parameter sheet, on the drawing, with instructions for drive set up on Profibus and have backup float capability.
- III.3.13.4. VFD Float Backup Functional.
- III.3.13.5. Each VFD shall be wired with a Hand, Off and Auto switch. The three modes of operation are described below.
  - Off – The drive is disabled.
  - Manual – The drive shall turn on and ramp up to maximum speed.

# JEA Water and Wastewater Standards 435 Booster Wastewater Pumping Stations

- Auto – If the VFD selector switch is put into Auto and PLC Communication to the drive is ok then the drive will be controlled over the Profibus communication. If communication is ever lost to the VFD the Communication OK relay will drop out and control the VFD from the Float Control Relay. The Communication OK relay is controlled by the PLC and is to be energized as long as the VFD Communication is ok.

Below is the connection diagram for the hardwired interface to the VFD.

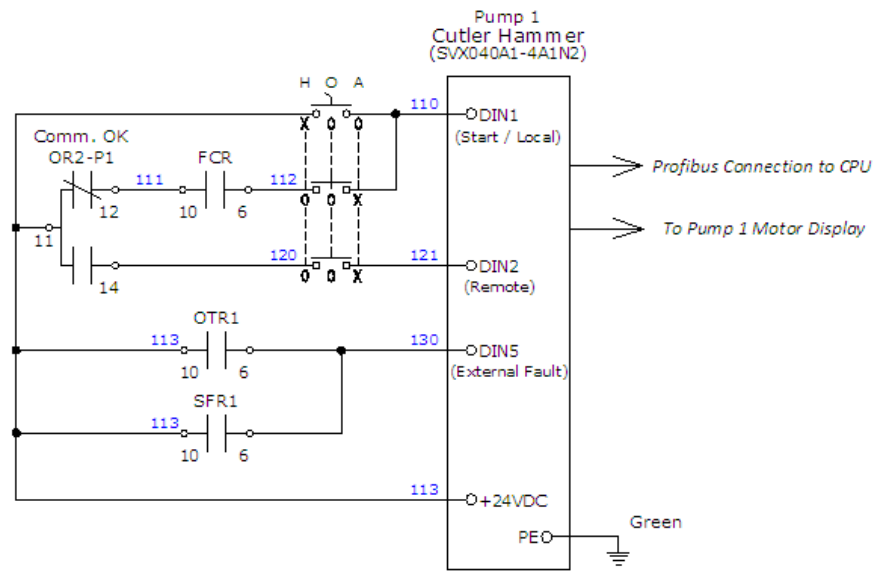

### III.3.13.6. Heat Load Calculations For Gasketed/Unvented Enclosures

All heat calculations shall be provided showing surface area, internal heat load of components broken out, Watts per square foot and any other pertinent data. This data shall be submitted with the enclosure drawing for approval.

III.3.13.6.1. The evaluation of the heat load on an enclosure, include the following:

- Total surface area of the enclosure in sq. ft.
- Internal heat load [load and duty cycle to be considered in calculation]
- Maximum allowable internal temperature [113F]; with an assumed outside temperature[95F]

III.3.13.6.2. Enclosure surface area is the primary factor in determining its ability to dissipate heat.

- Surface Area =  $2[(A \times B) + (A \times C) + (B \times C)] \div 144$
- Where the enclosure size is A x B x C in inches.
- This equation includes all six surfaces of the enclosure.
- If any surface is not available for transferring heat (for example, an enclosure surface mounted against a wall), that surface's area should be subtracted.

III.3.13.6.3. For any temperature rise calculation, the heat generated within the enclosure or internal heat load shall be known. This information can be

# JEA Water and Wastewater Standards

## 435 Booster Wastewater Pumping Stations

obtained from the supplier of the components mounted in the enclosure. Any internal heat calculation shall include but is not limited to the following components:

- Transformer Power Supply UPS PLC Circuit Breakers Heat Load Main All Pump circuit breakers taking into consideration duty cycle.
- VFD Heat Load  
 If VFD is inside the enclosure assume Heat Load = (746W x HP x 3%)  
 If VFD heat sink is out back assume Heat Load = (746W x HP x 3%) x 10% Note: the 10% is from current manufacturer's statement that with heat sinks out the back only 10% of the heat will be dissipated inside the enclosure. Other manufacturers may require a greater percentage and must adjust the formula accordingly.
- VFD Duty Cycle
  - For two pumps VFD applications assume worst case of one pump running continuously.
  - For three pumps VFD applications assume worst case of two pumps running continuously.

### III.3.13.6.4. Enclosure Temperature Rise ( $\Delta T$ )

Example:

What is the temperature rise that can be expected from a 72 x 72 x 20 in. painted white enclosure designed to control 3 VFD's with external mounted heat sinks?

Solution:

$$\text{Surface Area} = 2[(72 \times 72) + (72 \times 20) + (20 \times 72)] \div 144 = 112 \text{ ft}^2$$

- Internal Heat Load (Min.)

Component	Load	Full Load Loss	Loss
Control Transformer	50%	21.5w	11w
24VDC Power Supply		15w	15w
CPU 313C-2DP		14w	14w
Analog Input Module		1w	1w
Communication Module		6w	6w
3 Pole 200 Amp [2]	33% (65amps per drive)	80w per breaker at 200 amps	53w
[2] 50 HP VFD	100%	112w per drive	224
Misc.			13w
Total			337w

\*Full Load loss data from component specifications sheets.

- Watts per Square Foot = total internal watts / surface area = 337/112 = 3 Watts/Square Foot



# JEA Water and Wastewater Standards

## 435 Booster Wastewater Pumping Stations

- Temperature Rise  $[\Delta T] = 15$  degrees F

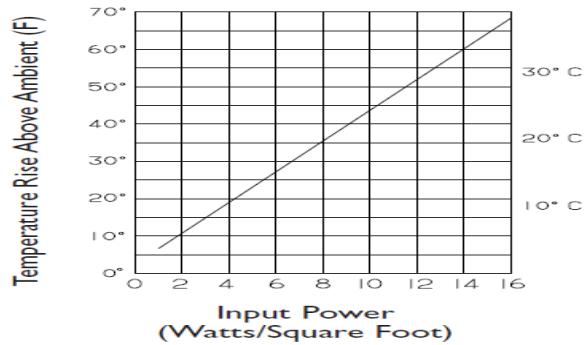

### III.3.13.7. Air Conditioning

Reference JEA Facilities Standards Manual Division 23. Only buildings will require air conditioning shall meet the specifications below.

III.3.13.7.1. Air conditioners shall be rated NEMA 4X and Corrosion Resistant.

III.3.13.7.2. Buildings shall require heating strips.

III.3.13.7.3. AC Units shall carry a minimum of a 3 year warranty in a corrosive environment.

### III.3.13.8. Surge Suppression

Surge Protective Devices (SPD) for 120VAC and above shall be UL1449 Third edition.

III.3.13.8.1. The Main Disconnect shall have a Type 1 SPD rated NEMA 4X. It will have a minimum surge capacity of 50kA at 8x20us

III.3.13.8.2. The Control Panel shall have a minimum Type 2 SPD with a surge capacity of 40kA at 8x20us.or above.

III.3.13.8.3. The 4-20ma surge suppression shall be CITEL part # DLAW-24D3. No other device will be accepted.

### III.3.13.9. Additional Field Wiring Requirements

Some sites require additional inputs based on external field requirements. Below is a list of inputs for different field requirements. Generator Input requirements as listed.

- Discrete Inputs – Generator Fault,
- Transfer Switch Normal,
- Transfer Switch Emergency,
- Generator Running,
- Normal Power Available
- Fuel Leak,
- Analog Input 4-20ma – Fuel Level

# *JEA Water and Wastewater Standards*

## *435 Booster Wastewater Pumping Stations*

### III.3.13.10. UL Labels

The entire control system shall bear a UL 508A serialized label "Enclosed Industrial Control Panel". The use of the label "Industrial Control Panel Enclosure" without the UL508A serialized label shall not be acceptable.

### III.3.13.11. Warranty

III.3.13.11.1. The panel manufacturer shall supply to JEA a three (3) year (min.) unconditional warranty after completion or acceptance of MCC Panel on all parts supplied by the manufacturer, excluding parts supplied by JEA.

III.3.13.11.2. The warranty shall include materials and installation and shall constitute complete replacement and delivery to the site of materials and installation of same to replace defective material or defective workmanship with new materials/workmanship conforming to the specifications.

III.3.13.11.3. The panel manufacturer shall also be responsible to ensure that component manufacturer's warranty which exceeds the panel manufacturer's warranty is honored.

## III.4. COMPONENTS EXTERNAL TO THE PANEL

### III.4.1. FORCE MAIN PRESSURE TRANSDUCER

Every Lift Station shall have a Force Main Pressure Transducer. Transducer is to be rated 0-100PSI. Shall have a minimum 3 year warranty.

### III.4.2. POTABLE WATER PRESSURE TRANSDUCER

Every Lift Station is required to have a Potable Water Pressure Transducer which shall meet the following requirements:

- Display for pressure readings and programming interface
- Buttons for programming the device
- Lower/Upper range adjustments for (zero/span)
- DAC output adjustment
- Ability to zero the transducer with the press of a button
- Configured for a -100 PSIG range and a 4-20ma output
- Minimum 3-year warranty

### III.4.3. DEMARCATION BOX

A Demarcation box shall be used as an isolation point between the pump and the motor control center panel. All wiring between the motor control center and wet well shall be interconnected at this point. Demarcation Box is divided into a base that is vented and a top that is NEMA 4X rated. Demarcation Box shall be fabricated from .125 marine grade brushed aluminum. Box shall be mounted so that doors face away from wet well. Only one pulling 90 degree ell at the base of the demarcation box is allowed. Conduit shall be stubbed up 3" from the base. The wire shall run in the open air at the base of the demarcation box with liquid tight cord connections at the bottom of the top demarcation box. Reference drawings and information below for more details.

# ***JEA Water and Wastewater Standards***

## ***435 Booster Wastewater Pumping Stations***

- III.4.3.1. Demarcation Top – Shall be 30" Width x 24" Height x 12" Depth, NEMA 4X, hinged door, 3-Point Latch with a padlock feature.
- III.4.3.2. Demarcation Base – Shall be 30" Width x 36" Height x 12" Depth, vented on sides, hinged door and two padlocking ¼ turn wing latches on the front of the door.
- III.4.3.3. Terminals – Shall be mounted on removable back plate, terminal for each wire, terminal sized according to load and minimum terminal size shall be 4mm. Antioxidant compound shall be used on all terminals and wire connections.
- III.4.3.4. Liquid Tight Cord Connections – Shall be made of cast aluminum.
- III.4.3.5. All wires including spares shall be identified with heat shrink labels. All control wires shall have spade lugs.

### **III.4.4. POWER DISTRIBUTION PANEL**

Panel to distribute power to devices external to the control panel. It shall be fabricated from .125 marine grade brushed aluminum or 316 stainless steel. Reference site drawings for details.

### **III.4.5. RADIO POLE/TOWER**

The radio pole or tower shall provide communication to the SCADA cabinet to the remote master. To determine if a pole or tower is required a Radio Path Study shall first be conducted. The Radio Path Study shall be done using the same type of radio used in the SCADA panel and shall be a minimum of -86DB RSSI. If the height of the minimum -86DB RSSI level is less than or equal to 20' then a 20' pole shall be used. If the height requirements are over 20' then a tower shall be used. Refer to drawings for specifications on Pole and Tower.

### **III.5. SERVICE**

The manufacturers or representatives shall provide two hour on site emergency service for the first 12 months after commissioning. The manufacturer shall stock replacement components locally for emergency replacement as needed.

### **III.6. START UP**

The manufacturer or representative shall be present for startup at time designated by JEA.

### **III.7. OPERATING PROCEDURES**

MCC supplier shall provide written "Standard Operating Procedures" to JEA.

## **IV. PREFABRICATED CONCRETE ENCLOSURE**

The prefabricated building system shall be factory assembled, pre-tested, shipped to the site, and suitably anchored to the respective concrete foundations. In the case of a conflict between this specification section and the current JEA Standards, the more stringent of the two requirements shall apply. The enclosure design and construction shall conform to all applicable federal, state, and local building codes and standards including the current Florida Building Code, D1.1 Structural Welding Code, ACI-318-02 and ACI-318R-02. The enclosure shall be guaranteed to be completely weather-tight under all weather conditions for a period of three (3) years (min). Leaks which occur during the period, whether through roofs, walls, doors, accessory equipment, or materials, shall be repaired to the satisfaction of JEA at no additional cost to JEA. Contractor shall verify all openings and penetrations, and shall coordinate with the manufacturer prior to casting.

# *JEA Water and Wastewater Standards*

## *435 Booster Wastewater Pumping Stations*

### **IV.1. DESIGN REQUIREMENTS**

- IV.1.1. The enclosure shall be constructed of solid, one-piece concrete panels. Minimum outside dimensions of the building shall be 11'-8" x 28'-0". The minimum interior clear height shall be 10'-0". Panels shall be bolted or welded together and joints caulked inside and out to make the building weatherproof. The wall panels shall be minimum 3-1/2" thick solid panels of concrete with primary structural reinforcement of steel bars and welded wire fabric. Wall panel assembly shall develop strength to resist the design wind loads. Wall panels shall be continuous from base to leave with no horizontal joints.
- IV.1.2. The roof shall have a gable profile with the ridge parallel to the long dimension and shall have a minimum 4" thick concrete panel extending over the walls to act as a drip edge. The roof shall contain primary reinforcement of steel bars and welded wire fabric as well as secondary reinforcement of polypropylene fibers.
- IV.1.3. The interior finish on the walls shall be 3/4" plywood panels with plastic laminate suitable for equipment mounting and insulated to R-14. The ceiling shall be 5/8" gypsum and insulated to R-21. All fasteners and nails shall be 316 stainless steel.
- IV.1.4. The exterior surfaces of the walls shall have a stucco texture finish. The exterior shall be finished with a cementitious base coating and a topcoat of textured 100% acrylic. The topcoat shall be of the same manufacturer as the cementitious base coating. Colors will be selected after the award of the contract exterior flashing and fasteners shall be 316 stainless steel.
- IV.1.5. Caulking shall be provided at all bases, corners, eaves, doors, and other openings to provide a completely weather-tight installation. Sill angles and door frames shall be caulked in place and sealed.
- IV.1.6. All necessary erection hardware, fasteners, trim, flashing, closures and other accessories necessary for a complete building shall be furnished. The enclosure shall be assembled in accordance with the building manufacturer's instructions. All members shall be carefully leveled. All welding shall be in accordance with AWS D1.1 Structural Welding Code.

### **IV.2. DOORS AND HARDWARE**

The building shall be provided with a pair of 2'-6" x 7'-0" fiberglass reinforced plastic (FRP) doors for equipment installation and a 3'-0" x 7'-0" FRP personnel door as indicated on the drawings. The color of the door shall be selected after award of the contract. Hardware shall be furnished and installed by the door manufacturer. The hardware shall be 316 stainless steel provided for the building and shall include mortise locks on each door set interchangeable core cylinders. Interchangeable core shall have Contractor's core in cylinder. Contractor core shall be provided with control key and registered change keys. Contractor will coordinate door hardware lock mechanism with the JEA representative. Hinges shall be heavy duty stainless steel. The location of hardware items shall be in accordance with DHI "Recommended Locations for Builders' Hardware. Hardware shall be stainless steel and furnished complete with machine screws, bolts, and other attachments as required. The contractor shall furnish complete specifications and catalog cuts of each item offered.

### **IV.3. ELECTRICAL**

The manufacturer of the building shall provide to the contractor any requirements necessary for the installation of the electrical equipment and conduits by the contractor as indicated on the drawings. This

# *JEA Water and Wastewater Standards*

## *435 Booster Wastewater Pumping Stations*

shall include recommended conduit penetration and sealing methods to ensure the weather-tight integrity of the building.

#### **IV.4. STRUCTURAL DESIGN**

The applicable building code shall be the latest Florida Building Code. The enclosure shall be designed to resist overturning and sliding forces resulting from wind loading. Embedments to be cast into the slab for anchorage shall be designed and provided by the building supplier. Structural design shall be performed by a Professional Engineer registered in the State of Florida and submittal of building components shall bear his/her seal. The building shall be designed for the following criteria (at a minimum):

- Roof live load, lb per sq ft of horizontal 20 psf projection (no live load reduction is permitted)
- Wind Load 120 mph, 3 second gust

#### **IV.5. PAINTING AND FINISHES**

All surfaces to receive paint shall be cleaned of any grease, dust, or dirt. Pre-finished surfaces shall be masked or otherwise protected to avoid damage from spilled paint, overspray, or spatter. Factory finished surfaces which have become damaged during shipping, assembly, or erection shall be touchup painted with materials supplied by the building manufacturer. No other finish will be accepted. All touchup painting shall produce a final finish satisfactory to JEA.

#### **IV.6. DRAWINGS AND DATA TO BE SUBMITTED**

IV.6.1. Complete specifications and drawings covering the doors and a complete hardware schedule shall be submitted in accordance with the Submittals section. Drawings shall indicate an elevation of the door, details of construction, assembly and erection details, profiles and thickness of materials, anchors, reinforcements, hardware coordination, and finish. Drawings shall be accompanied by the manufacturer's installation manual, indicating standard recommendations and details of erection. The hardware schedule shall indicate each item of hardware required, manufacturer's name, manufacturer's number or symbol, and finish.

IV.6.2. Complete drawings and data shall be furnished showing anchor bolt locations, sizes, and projections; details of sidewall, end wall, and roof framing; transverse cross-sections; locations of all openings; details of louver; flashing details; and erection instructions. Color samples of manufacturer's standard finishes shall be submitted. Drawings and data shall be in accordance with the submittals section.

#### **IV.7. CERTIFICATION**

A letter of certification signed and sealed by a professional engineer registered in the State of Florida shall be submitted for the structural framing, anchorage and covering panels of the building system.

#### **V. VALVES**

The contractor shall furnish and install check valves, plug valves, and appurtenances as shown on the drawings and as specified in JEA Water and Wastewater Standards Manual. Wastewater Valves and Appurtenances. Check valves shall be lever and weight style shall meet the following additional requirements. Rubber disc facing shall operate on a 316 stainless steel shaft connected to a steel outside lever and cast iron adjustable weight. Check valve shall include renewable seat and disc. Valves shall meet AWWA Standard C508 and rated at 150 psi (min.) working pressure.

#### **VI. TESTING**

# *JEA Water and Wastewater Standards*

## *435 Booster Wastewater Pumping Stations*

### **VI.1. ARC FLASH HAZARD ANALYSIS**

Contractor shall commission an Arc Flash Hazard Analysis for each piece of electrical equipment in accordance with OSHA 29 CFR Part 1910, NEC, NFPA 70E, and IEEE 1584 and shall submit an Arc Flash Hazard Analysis report as specified herein.

VI.1.1. The Arc Flash Hazard Analysis shall be performed in association with, or as a continuation of, the short circuit study and protective-device coordination study.

VI.1.2. Arc Flash Hazard Analysis calculations shall lead to a selection of a level of Personal Protective Equipment (PPE) that is a balance between the calculated incident energy exposure and the work activity being performed, while meeting the following concerns:

VI.1.2.1. Provide adequate protection.

VI.1.2.2. Avoid the need for more protection than is warranted.

VI.1.3. Results of the Arc Flash Hazard Analysis shall be used to identify the flash- protection boundary and the incident energy at assigned working distances throughout any position or level in the overall electrical generation, transmission, distribution, or utilization system.

VI.1.4. The analysis shall include, but shall not be limited to, the following

VI.1.4.1. A tabulation of the symmetrical RMS bolted fault current available and X/R ratio at each piece of electrical equipment.

VI.1.4.2. A tabulation of the arc fault current available at each piece of electrical equipment

VI.1.4.3. A list containing the incident energy and the flash-protection boundary for the electrical equipment being installed.

VI.1.4.4. A list containing each piece of electrical equipment, its corresponding incident energy, hazard rating, and the required Personal Protective Equipment.

VI.1.5. An engineering and testing services firm acceptable to Owner shall conduct the Arc Flash Hazard Analysis.

### **VI.1.6. ARC FLASH ANALYSIS SOFTWARE**

The Arc Flash Hazard Analysis shall be performed using the latest version of SKM Power\*Tools for Windows software, without exception. After the final version of the study and analysis are completed and accepted, Contractor shall provide two (2) copies of the SKM electronic file to Owner.

### **VI.1.7. ARC FLASH HAZARD REPORT**

VI.1.7.1. Contractor shall be responsible for submitting complete and accurate arc flash analysis information in the Arc Flash Hazard Report. The report shall be submitted to Owner for review before the final report is prepared. Contractor shall ensure that calculated values for flash-protection boundary, working distance, incident energy, and required Personal Protective Equipment is submitted and provide substantiation that the information will be prominently displayed on electrical equipment.

## *JEA Water and Wastewater Standards 435 Booster Wastewater Pumping Stations*

- VI.1.7.2. The Arc Flash Hazard Analysis report shall be bound in a standard 8-1/2 by 11 inch three-ring binder and shall be submitted in accordance with the Submittals section. Final selection of required Personal Protective Equipment shall be subject to review and acceptance by Owner.
- VI.1.7.3. Arc Flash Labeling. After approval of the Arc Flash Hazard Report, Contractor shall furnish and install arc flash warning labels on the applicable electrical equipment. Electrical equipment shall be provided with the appropriate ANSI compliant arc flash labeling. Labels shall include the flash protection boundary distance, incident energy, and minimum required Personal Protective Equipment.

### **VI.2. COORDINATION STUDY**

Contractor shall commission a short circuit study and protective-device coordination study of relays, fuses, circuit breakers, and any other protective devices and shall submit a coordination report as specified herein. The study shall include the entire electrical distribution system from high side of distribution transformer and finishing with the smallest – 480 volt, 3 phase, 60 Hz – circuit protective device on the load end.

- VI.2.1. Contractor shall be responsible for and shall ensure that relays and circuit breakers are set according to the study results.
- VI.2.2. The study shall include, but shall not be limited to, the following:
  - VI.2.2.1. Color-coded printouts of coordination curves prepared with calculation software.
  - VI.2.2.2. A tabulation for any protective relay and circuit breaker trip settings and recommended sizes and types of medium-voltage fuses.
  - VI.2.2.3. Motor starting profiles for 50 horsepower [37 kW] and larger motors.
  - VI.2.2.4. Transformer damage curves and protection, evaluated in accordance with ANSI/IEEE C57.109.
  - VI.2.2.5. Coordination curve(s) from the power company, if available.
  - VI.2.2.6. Calculated short-circuit values at nodes in the distribution system included within the scope of the coordination study.
- VI.2.3. An Engineering and Testing Services firm acceptable to Owner shall conduct the coordination study.
- VI.2.4. Contractor shall be responsible for obtaining the following:
  - VI.2.4.1. The coordination curves for relays, fuses, and circuit breakers. Transformer damage curves.
  - VI.2.4.2. Motor data.
  - VI.2.4.3. Other applicable information for any new and existing electrical equipment.

## *JEA Water and Wastewater Standards*

### *435 Booster Wastewater Pumping Stations*

VI.2.4.4. Contractor shall coordinate with the power company to obtain the required protective device curves and shall be responsible for any field work associated with obtaining the necessary data on existing relays, circuit breakers, fuses, and transformers to be included in the coordination study.

VI.2.4.5. The available 3 phase, symmetrical fault current at the point of service shall be obtained from the Power Company.

VI.2.5. The coordination report shall be bound in a standard 8-1/2 by 11 inch [210 by 275 mm] three-ring binder and shall be submitted in accordance with the Submittals section. Final selection of protective device settings or sizes shall be subject to review and acceptance by Owner.

### **VI.3. PUMP FACTORY TESTS**

The pump manufacturer shall perform the following tests on each pump prior to shipment.

VI.3.1. Meg the pump motor and cable for insulation breaks or moisture intrusion.

VI.3.2. Prior to submergence, run pump dry and check for correct rotation.

VI.3.3. Pump shall be run continuously for 30 minutes in a submerged condition, with a minimum submergence of 10 feet.

VI.3.4. Pump shall be removed from test tank, megged immediately for moisture and all seals checked for water intrusion.

VI.3.5. Pumps shall be operated at a minimum of 6 points to establish the hydraulic curve. KW input shall be monitored and recorded. One test point shall be performed with discharge valve closed. Pumps shall develop appropriate capacity and head within Hydraulic Institute Standards without excessive noise, vibration or cavitation. If specifically requested by JEA, a vibration test shall be performed on each pump to demonstrate compliance.

VI.3.6. For pumps less than 100 HP, the pump supplier shall submit copies of certified Hydraulic Institute test reports including factory pump curves of identical model pump (s) provided to JEA (in lieu of written certified test reports for each pump supplied).

VI.3.7. For pumps 100 HP and greater, the above certified pump performance test (at a minimum) must be completed on each actual pump supplied. A JEA representative(s) shall be present to witness the certified test (JEA's travel expenses by JEA).

### **VI.4. FIELD ACCEPTANCE TESTING**

#### **VI.4.1. PRE-FINAL INSPECTION**

Prior to final inspection, the Contractor shall conduct a pre-final site inspection (including energizing each pump), in the presence of a JEA representative. Any deficiencies noted at this time shall be corrected prior to scheduling of the final inspection.

#### **VI.4.2. FINAL INSPECTION**

The Contractor shall be responsible for conducting the following field acceptance tests and start-up procedures in the presence of a JEA representative. The Contractor shall notify JEA, the



# *JEA Water and Wastewater Standards*

## *435 Booster Wastewater Pumping Stations*

Engineer and the pump manufacturer's representative 48 hours prior to start-up. The time and date of this final inspection shall be scheduled by JEA. The Contractor shall furnish all labor, piping, equipment, water and materials required to perform the acceptance testing. The Contractor shall ensure the force main is full of water prior to the pump test. The contractor shall submit proof of compliance with electric site grounding requirements. JEA will complete a final inspection checklist for acceptance.

### VI.4.2.1. Pump Performance

Prior to acceptance, as part of the final inspection, and prior to placing the station in operation, the Contractor shall conduct a pump performance test. Pumps shall operate according to the operating conditions indicated on the drawings without excessive vibration or overheating. Testing shall be performed using clean water. The Contractor shall supply water at its own expense to perform the required testing. Pumping rates shall be determined by pumping a calculated volume of water in a specified time interval. Head and flow conditions shall be measured and recorded. Water levels during testing shall fall within the pump control levels shown on the drawings. Amperage draws shall be monitored to determine effectiveness and efficiency of equipment. The test shall be repeated until satisfactory results are obtained. The test results shall be recorded on the Pump Test Report sheet included in the appendix section herein. If the Contractor is unable to demonstrate to JEA that the pumping unit performs satisfactorily, the unit shall be rejected. The Contractor shall then remove and replace the defective unit at its own expense. Satisfactory performance includes, but is not limited to, the following:

#### VI.4.2.1.1. Pumps

Pumps shall deliver rated GPM at rated TDH.

#### VI.4.2.1.2. Motors

Running amperage shall be noted and recorded on each leg of power cord while pump is operating under full load.

VI.4.2.1.3. All self-test trip relays shall demonstrate ability to simulate a fault condition. All test results shall be recorded on the pump test report and be submitted to the Engineer.

VI.4.2.1.4. Pumps shall operate within 5 % of the approved, certified, head-capacity curve.

VI.4.2.1.5. Following performance testing, pumps shall be megged for pump-moisture intrusion.

VI.4.2.1.6. Pump spare parts are not required unless specifically noted otherwise.

VI.4.2.1.7. For dry-pit submersible pumps, the closed loop cooling system shall provide adequate cooling, in accordance with pump manufacturer's recommendation, throughout the pumping range.

### VI.4.3. SCADA INSPECTIONS

# *JEA Water and Wastewater Standards*

## *435 Booster Wastewater Pumping Stations*

A JEA representative shall conduct the following field acceptance test and start up procedures in the presence of the contractor.

### **VII. REFERENCE POINTS AND LAYOUT**

The Contractor shall be responsible for setting all grade stakes, lines and levels. The Contractor or Contractor's Surveyor will provide centerline of construction and will establish a bench mark. Any reference points, points of intersection, property corners, or bench marks, which are disturbed during construction, shall be restored by a Land Surveyor registered to practice in the State of Florida, and all costs thereof shall be borne by the Contractor. The Contractor shall assume all responsibility for the correctness of the grade and alignment stakes.

### **VIII. EXCAVATION**

The Contractor shall make all excavations for piping and appurtenant structures in any material encountered to the depth and grades indicated on the plans, shall backfill such excavations to the depth and grades indicated on the plans, shall backfill such excavations and dispose of excess or unsuitable materials from such excavations, and shall provide and place necessary borrow material to properly backfill excavations, all as indicated on the drawings, specified herein or as directed by the Engineer. All work shall be in accordance with the Water and Wastewater Standards, Excavation and Earthwork – Section 408.

### **IX. WASH DOWN STATION**

#### **IX.1. WATER SERVICE PIPING**

Water service piping shall be 1½ inch diameter (minimum). Water meter, shall be 1½ inch diameter (minimum). Materials and installation shall meet JEA's standards for typical water service construction.

#### **IX.2. BACKFLOW PREVENTER**

The Contractor shall furnish and install a 1½ inch reduced pressure backflow preventer which meets the requirements of JEA's Cross Connection Control Policy (see details on drawings).

#### **IX.3. WATER SERVICE & METER**

The contractor/developer shall secure the water for the pump station site by applying for either a commercial 1 ½ inch water only meter (if no irrigation water use is included with meter) or commercial 1 ½ inch irrigation meter (if irrigation water use is included with this meter). The contractor/developer is responsible for all JEA fees. The Contractor shall install the meter box and service in accordance with all applicable JEA Standard Details and Specifications and JEA will install the meter. The Contractor shall be responsible for the cost of all water used during construction and testing. The water service will then be transferred to JEA upon final acceptance of the pump station.

#### **IX.4. HOSE**

Wash down hose to be white cover paper mill creamery wash-down hose with tapered nozzle. Hose length shall be sufficient to reach the entire site from hose station.

### **X. SITE WORK**

#### **X.1. SITE PLAN**

The site plans shall be designed site specific. The site plan shall indicate the actual site and orientation of all structures, panels and piping, at a minimum.

#### **X.2. GENERAL**

# *JEA Water and Wastewater Standards*

## *435 Booster Wastewater Pumping Stations*

All work shall be in accordance with the following specification sections, at a minimum: Chapter II. 1. - Section 406 - Site Preparation, Cleanup and Restoration, Chapter II. 2. - Section 407- Demolition and Abandonment, Section 408 - Excavation and Earthwork and Chapter II. 5. - Section 437 – Concrete Work. Slope concrete and site to drain towards street or other adjacent, JEA or City owned drainage facility.

### **X.3. DRIVEWAYS AND SITE**

All JEA pump stations shall be provided with a permanent site access road structure of traffic rated concrete or asphalt. The access roadway shall be 12' wide and have adequate fillets for turning a vehicle around, if needed. The driveway apron from the roadway to the pump station shall be concrete only.

#### **X.3.1. CONCRETE**

All work under this section shall be of 3,000 PSI concrete with reinforcing wire or fiber mesh. Thickness of concrete shall be 5 inches (minimum).

#### **X.3.2. EXPANSION JOINTS**

Expansion joints shall be pre-formed joint fillers meeting the requirements of AASHTO M153 or AASHTO 213 and cut to the true shape of the cross section, set to line and grade and held true while the concrete is being placed. The joint shall be edged and finished in a workmanlike manner. These strips shall be left in place and shall be placed adjacent to the paving, curb driveway aprons, structures and pads, or as specified by the Engineer. Expansion Joints which are not adjacent to the structures listed above may be 1 inch by 4 inch pressure treated lumber or other approved materials and shall appear every 18 feet, at a minimum or be placed between truckloads of concrete that exceed the time limits specified in the JEA Water and Wastewater Standards Chapter II. 5. - Section 437 Concrete Work.

#### **X.3.3. CONTRACTION AND CONSTRUCTION JOINTS**

Contraction and construction joints shall be placed and formed by means of an approved jointer template. The stem of the jointer shall be pressed into the freshly finished concrete forming a groove 1/2 inch deep. The edges of the groove and adjacent surface shall be neatly finished. Unless otherwise shown on the plans or designated by the Engineer, these joints shall be placed at 6 foot intervals between expansion joints.

#### **X.3.4. SURFACE REQUIREMENTS**

The concrete shall be given a broom finish. The surface variations shall not be more than 1/4 inch under a ten foot straight edge, nor more than 1/8 inch on a five foot transverse section. The edge of the concrete shall be carefully finished with an edging tool having a radius of 1/2 inch.

### **X.4. ROCK COVER**

When indicated on the drawings, the Contractor shall furnish and install 6 inches of No. 57 (1" nominal diameter) crushed limestone placed over a 10 mill plastic membrane.

### **X.5. FENCING**

Fencing shall be furnished and installed in accordance with details on the drawings.

## **XI. PERMITS**

The Engineer will supply the land clearing permit. The Contractor shall secure and pay for all plumbing, electrical, right-of-way and other required permits. The Contractor shall make application and pay applicable fees for electric and water meters. The Contractor shall be responsible for all costs associated with utilities used during

# *JEA Water and Wastewater Standards*

## *435 Booster Wastewater Pumping Stations*

construction and testing of the pump station. Upon final acceptance or, if approved, following substantial completion of the project, the JEA Pump Station Manager shall, by letter to JEA, transfer services to JEA.

### **XII. LANDSCAPING**

Plants shall be of the types and placed in the locations as indicated on JEA's Minimum Standards for Landscaping as included in the Sewage Pump Standard Details (Latest revision) and as approved by local landscape code enforcement.

### **XIII. SPRINKLER SYSTEM**

#### **XIII.1. GENERAL**

Sprinkler system shall consist of a single main traveling around the perimeter of the pump station site. Sprinkler system shall form a complete loop and be connected to the hose station downstream of the backflow preventer, as indicated on the drawings. Sprinkler system shall be operated by a single stage timer located in the control panel. Sprinkler system shall be designed by the sprinkler supplier, which shall be a firm regularly engaged in the design and supply of sprinkler systems.

#### **XIII.2. COMPONENTS**

XIII.2.1. Sprinkler system shall consist of mister heads on 2 foot tall, black, risers around perimeter of pump station paving at site. System shall provide 100% cover over the buffer zone (plant zone), while minimizing the over spray to less than 5% of the volume of water delivered. Provide irrigation to land between pump station and road paving.

XIII.2.2. Commercial grade, 12 inch pop-up, gear driven sprinklers may be used if necessary for this area only. Mister heads on risers shall be required around pump station perimeter.

#### **XIII.3. SUBMITTALS**

Shop drawing submittals will be required on sprinkler system design and components.

#### **XIII.4. DRAIN VALVE**

Sprinkler system shall include ½ inch solid brass automatic drain valves, Nelson #8819 or JEA pre-approved equal. Drain valve shall carry a 5-year warranty against failure and be installed in a plastic landscape valve box as depicted on drawings.

#### **XIII.5. WATER SERVICE**

If applicable, an irrigation water meter service shall be provided for the sprinkler system. In this case, the Contractor may be required to secure the irrigation meter by submittal of a JEA irrigation meter application and payment of applicable fees. If available, reclaimed water should be utilized for all irrigation.

### **XIV. INSPECTION CHECKLISTS AND REPORTS**

# JEA Water and Wastewater Standards 435 Booster Wastewater Pumping Stations

## XIV.1. JEA BOOSTER PUMP TEST REPORT

**PROJECT** \_\_\_\_\_ **DATE** \_\_\_\_\_

STREET ADDRESS \_\_\_\_\_

LONGITUDE \_\_\_\_\_ LATITUDE \_\_\_\_\_

WATER METER NO. \_\_\_\_\_

ELECTRIC METER NO \_\_\_\_\_

### EMERGENCY BACKUP

GENERATOR MAKE \_\_\_\_\_ GEN MODEL \_\_\_\_\_

GENERATOR SIZE (KW) \_\_\_\_\_ FUEL TANK (gal) \_\_\_\_\_

AUX PUMP SIZE (Inches) \_\_\_\_\_ HP \_\_\_\_\_ FUEL TANK (gal) \_\_\_\_\_

AUX. PUMP MAKE \_\_\_\_\_ AUX PUMP MODEL \_\_\_\_\_

AUX. ENGINE MAKE \_\_\_\_\_ AUX ENGINE MODEL \_\_\_\_\_

### PUMP DATA

MANUFACTURER \_\_\_\_\_ MODEL \_\_\_\_\_ HP \_\_\_\_\_

DISCHARGE SIZE (Inch) \_\_\_\_\_ VOLTAGE \_\_\_\_\_ PHASE \_\_\_\_\_

IMPELLER SIZE (Inch) \_\_\_\_\_ RPM \_\_\_\_\_ FLA \_\_\_\_\_

### DESIGN DATA

PUMP DESIGN POINT \_\_\_\_\_ GPM \_\_\_\_\_ @ T.D.H \_\_\_\_\_

### TEST DATA

PUMP NUMBER	1	2	3	4
SERIAL NUMBER				
FLOW (GPM)				
INLET PRESSURE (PSI)				
OUTLET PRESSURE (PSI)				
AMP READING (PER LEG)				

*JEA Water and Wastewater Standards  
435 Booster Wastewater Pumping Stations*

COMMENTS

---

CONTRACTOR REP

---

*Signature    Print name*

JEA INSPECTOR

---

*Signature    Print name*

JEA O&M REP

---

*Signature    Print name*

PUMP REP

---

*Signature    Print name*

ENGINEERING REP

---

*Signature    Print name*

# JEA Water and Wastewater Standards 435 Booster Wastewater Pumping Stations

## XIV.2.JEA MECHANICAL FINAL INSPECTION CHECKLIST

Project Name: \_\_\_\_\_

Street/Intersection/Address: \_\_\_\_\_

		Checked
1	All valves operate from the closed to the fully open position	<input type="checkbox"/>
2	All valves seal when closed	<input type="checkbox"/>
3	All valves open turning to the left, and an indicating arrow is cast into the metal	<input type="checkbox"/>
4	All valves are easy to operate and have no sharp protrusions on hand wheels	<input type="checkbox"/>
5	All fasteners are SS, and mountings are tightened correctly	<input type="checkbox"/>
6	Discharge piping is installed plumb with both horizontal and vertical alignment provided	<input type="checkbox"/>
7	Pressure gauge provided	<input type="checkbox"/>
8	Check valve has vertical support	<input type="checkbox"/>
9	Check for correct pump rotation as indicated by the arrow on the pump casings	<input type="checkbox"/>
10	Turn the circuit breaker for each pump and ensure that the correct pump starts	<input type="checkbox"/>
11	With one valve open, start the associated pump in manual mode and check for leaks, pump/motor vibrational noise, and well level drop	<input type="checkbox"/>
12	Shut valve and restart pump, checking for any leaks in piping/valves	<input type="checkbox"/>
13	Site light installed in gravel pit	<input type="checkbox"/>
14	All above ground pipe/fittings/valves have approved coating applied (two coats)	<input type="checkbox"/>
15	Provide electronic photos of pump station showing overall site, valves, panels, etc.	<input type="checkbox"/>

OK

Rework Required

COMMENTS

\_\_\_\_\_  
*Signature*      *Print name*

CONTRACTOR REP

\_\_\_\_\_  
*Signature*      *Print name*

JEA INSPECTOR

\_\_\_\_\_  
*Signature*      *Print name*

JEA O&M REP

\_\_\_\_\_  
*Signature*      *Print name*

PUMP REP

\_\_\_\_\_

ENGINEERING REP

\_\_\_\_\_  
*Signature*      *Print name*

# JEA Water and Wastewater Standards 435 Booster Wastewater Pumping Stations

## XIV.3.JEA GENERATOR FINAL INSPECTION & COMMISSIONING CHECKLIST

Project Name: \_\_\_\_\_

Street/Intersection/Address: \_\_\_\_\_

		Checked
1	Run generator in "manual" mode; check hertz, voltage, etc; verify operation of load bank	<input type="checkbox"/>
2	Verify certified affidavit of start-up and load testing from manufacturer's representative	<input type="checkbox"/>
3	Receipt of manufacturer's warranty (5-year)	<input type="checkbox"/>
4	Test "auto shut-down" on over speed circuit	<input type="checkbox"/>
5	Test to see if generator meets decibel requirements of <i>Specifications</i>	<input type="checkbox"/>
6	Simulate power failure (disconnect main breaker); verify automatic start of generator	<input type="checkbox"/>
7	Verify automatic transfer of power to emergency source; check for proper time delay between sequences.	<input type="checkbox"/>
8	Verify fuel tank and generator anchor bolts and related hardware is stainless steel.	<input type="checkbox"/>
9	Let run for ten (10) minutes	<input type="checkbox"/>
10	Restore utility power source; verify automatic transfer, cool-down cycle time, and shut down	<input type="checkbox"/>
11	Test load bank for proper operation	<input type="checkbox"/>
12	Ensure that separate circuits are provided for battery charger and block heater	<input type="checkbox"/>
13	Test block heater and battery charger for proper operation	<input type="checkbox"/>
14	Check for leaks	<input type="checkbox"/>
15	Check fuel monitoring gauges and interstitial gauges are accurate and working properly.	<input type="checkbox"/>
16	Check for bent, kinked, or dented supply or return	<input type="checkbox"/>
17	Check to make sure fuel tank shipped with a level indicator probe and an inch per gallon laminated fuel level chart.	<input type="checkbox"/>
18	Verify a handle and step is installed on the control panel door.	<input type="checkbox"/>
19	Verify the radiator has been coated with a bronze-glow corrosion resistive coating.	<input type="checkbox"/>
20	Verify the ball valves are installed on the Jacket Water Heater hoses, supply and return.	<input type="checkbox"/>
21	Verify the Jacket Water Heater hose is a silicone type.	<input type="checkbox"/>
22	Ensure that there is an oil vapor recovery box installed.	<input type="checkbox"/>
23	Confirm there is a spill response plan (SPCC) filed and a spill response kit installed on site for tanks larger than 1320 gallons.	<input type="checkbox"/>
24	Check for any threaded connections on tank are touched up with the supplied touch up kit. Any and all exposed uncoated metal should be coated.	<input type="checkbox"/>
25	External Piping is welded stainless steel	<input type="checkbox"/>
26	Verify Greenleaf system interface with SCADA for generator run sequences and fuel level.	<input type="checkbox"/>
27	Digital copies of warranties and Manuals	<input type="checkbox"/>



# JEA Water and Wastewater Standards 435 Booster Wastewater Pumping Stations

28	Inspect fuel filters for dirt, water, or other foreign matter	<input type="checkbox"/>
29	Check for water in the fuel filter	<input type="checkbox"/>
30	Inspect the entire air-intake system for openings that could draw in unfiltered air	<input type="checkbox"/>
30	Inspect dry element type filters and replace if clogged. Inspect for damaged seams and pleats.	<input type="checkbox"/>

Comments: \_\_\_\_\_

Contractor Rep: \_\_\_\_\_  
*Signature    Print name*

JEA Inspector: \_\_\_\_\_  
*Signature    Print name*

JEA O&M Rep: \_\_\_\_\_  
*Signature    Print name*

Commission Date: \_\_\_\_\_  
*Signature    Print name*

# JEA Water and Wastewater Standards 435 Booster Wastewater Pumping Stations

## XIV.4.JEA FACILITIES FINAL INSPECTION & COMMISSIONING CHECKLIST

Project Name: \_\_\_\_\_

Street/Intersection/Address: \_\_\_\_\_

\_\_\_\_\_

		Checked
1	Fence installed with approved materials in the manner specified	<input type="checkbox"/>
2	Fence installed free of any large gaps (those greater than 6 in.) at sides/corners	<input type="checkbox"/>
3	Fence installed with maximum clearance of 6 in. above finished grade	<input type="checkbox"/>
4	Fence installed with a minimum 12 in. mow strip, with galvanized anchors every 3-5 ft.	<input type="checkbox"/>
5	Maximum fence post span 10 ft. or less	<input type="checkbox"/>
6	Fence at least 6 ft. high, chain-link mesh (9 gauge minimum) with 3 strands of barbed wire extended outwards from top of fence at a 45-degree angle with the smooth side of the fence on the outside wall. Materials approved by Security and Facilities.	<input type="checkbox"/>
7	Inspect fence posts and fabric for correct material (vinyl coated black or green)	<input type="checkbox"/>
8	Gate installed with approved materials in the manner specified	<input type="checkbox"/>
9	Gate installed free of any large gaps at sides	<input type="checkbox"/>
10	Gate installed with maximum clearance of 6 in. above finished grade	<input type="checkbox"/>
11	Gate has an adequate catch to ensure the gate cannot be pushed in or pulled out	<input type="checkbox"/>
12	Gate installed with minimum height 72 in. for fence fabric (usually chain link), plus 3 strands of barbed wire, or using fabric/material with a minimum height of 96 in.	<input type="checkbox"/>
13	Gate operates smooth and freely, without stress on gate operator	<input type="checkbox"/>
14	Operator appears to be adequately anchored	<input type="checkbox"/>
15	Operator is the unit specified	<input type="checkbox"/>
16	Exit/Safety loops installed at required distances and function properly	<input type="checkbox"/>
17	Limit switches appear to be set appropriately	<input type="checkbox"/>
18	Inspect asphalt; check slope for proper drainage (no puddles)	<input type="checkbox"/>
19	Card readers are appropriate models, installed appropriately, and function correctly	<input type="checkbox"/>
20	Storm drain gates clean and open	<input type="checkbox"/>
21	Ensure that all debris has been removed from the site	<input type="checkbox"/>
22	Ensure that all required signage has been installed (incl. Pump Station I.D. sign)	<input type="checkbox"/>
23	Fire hydrant as specified and operating (if applicable)	<input type="checkbox"/>
24	All landscaping is to JEA standards	<input type="checkbox"/>
25	Irrigation is installed and functions properly (Establishment Only)	<input type="checkbox"/>
26	Copy of Backflow Certification sent Building Ops	<input type="checkbox"/>

Comments: \_\_\_\_\_

***JEA Water and Wastewater Standards  
435 Booster Wastewater Pumping Stations***

Contractor Rep: \_\_\_\_\_

JEA Inspector: \_\_\_\_\_  
*Signature    Print name*

JEA O&M Rep: \_\_\_\_\_  
*Signature    Print name*

Commission Date: \_\_\_\_\_  
*Signature    Print name*

\_\_\_\_\_  
*Signature    Print name*

\_\_\_\_\_

# JEA Water and Wastewater Standards 435 Booster Wastewater Pumping Stations

## XIV.5.JEA ELECTRICAL PRE-COMMISSIONING CHECKLIST

Project Name: \_\_\_\_\_  
 Street/Intersection/Address: \_\_\_\_\_  
 \_\_\_\_\_

		Checked
1	Check that all defects from switchboard inspection have been addressed	<input type="checkbox"/>
2	Electricity supply has been connected and energized. Certificate of Compliance for Electrical Work (CCEW) and associated paperwork has been supplied	<input type="checkbox"/>
3	Pump with the lowest serial number is installed as Pump 1 (i.e. nearest to switchboard)	<input type="checkbox"/>
4	Specified pump number labels are correctly installed adjacent to the pumps	<input type="checkbox"/>
5	"DANGER ELECTRIC" marker bricks installed at ground level and painted yellow	<input type="checkbox"/>
6	Earth electrode installed as specified	<input type="checkbox"/>
7	Earth pit, main earth electrode and water service bond installed	<input type="checkbox"/>
8	Meter panels are equipped and wired to requirements	<input type="checkbox"/>
9	Cable supports within the pump well are correctly located and properly fixed	<input type="checkbox"/>
10	No cable stocking has more than one cable installed in it	<input type="checkbox"/>
11	Motor cables are supported so as to avoid damage when removing other pump/pumps	<input type="checkbox"/>
12	Motor cables have minimal slack and do not present undue stress on motor cable glands	<input type="checkbox"/>
13	Check that the cable duct cover is held firmly under the edge of the concrete plinth by the well sliding cover. Also, check that it is held firmly under the edge at the switchboard end.	<input type="checkbox"/>
14	Appropriate lugs fitted to all field cables, and cables correctly identified at terminations	<input type="checkbox"/>
15	Confirm sufficient terminals installed for an individual terminal for every incoming field wire	<input type="checkbox"/>
16	Confirm all field wiring holes are mechanically protected (bushes, sleeves, etc.)	<input type="checkbox"/>
17	Motor terminations are in accordance with the connection diagram	<input type="checkbox"/>
18	All power cable terminations tested for tightness	<input type="checkbox"/>
19	Where parallel cables may be installed on site, provision has been made to ensure only one cable lug needs to be installed on each side of terminal lug	<input type="checkbox"/>
20	SCA rating plate complying with AS 3439 has been fixed	<input type="checkbox"/>
21	Confirm motor and pump details displayed on all labels are identical to the manufacturer's information. Take a copy of name plate information	<input type="checkbox"/>
22	Correct orientation and fixing of the switchboard as per design	<input type="checkbox"/>
23	Switchboard plinth and all gland plates sealed	<input type="checkbox"/>
24	<u>Check continuity of Earthing system:</u>	
	Main Earth	<input type="checkbox"/>
	Water pipe bond	<input type="checkbox"/>
	Pump I connection box	<input type="checkbox"/>

## JEA Water and Wastewater Standards 435 Booster Wastewater Pumping Stations

	Pump 2 connection box								<input type="checkbox"/>
	Pump 1 Motor								<input type="checkbox"/>
	Pump2 Motor								<input type="checkbox"/>
25	With the motor circuit breakers open and the control isolators off, tum the main switch on, and check that the supply monitoring relay picks up								<input type="checkbox"/>
26	Check operation of phase failure/phase reversal function of the power meter by removing one phase of supply. Also check by reversing the supply rotation to								<input type="checkbox"/>
27	Measure the voltages both phase to phase and phase to neutral. Compare the actual voltages relative to typical no-load voltage of 400/230V, and the voltage variation between phases should be less than 2%								<input type="checkbox"/>
28	Check settings of Starters(VSD or Soft starter)								<input type="checkbox"/>
29	If fitted, check operation of by-pass contactor								<input type="checkbox"/>
30	Check the motor and pump nameplates for all details and for compliance with the data shown on the pump rating plate. Take a copy of name plate information								<input type="checkbox"/>
31	For the following tests. test for pump 1, pump 2, pump 3 and pump 4	P1	P2	P3	P4				
	E-Stop								
	Overload								
	Motor Thermal Protection								
	Other: Check operation of all safety/protective devices for correct operation								
32	With the main switch, pump circuit breakers and control isolating switches off, conduct an insulation test with a megometer (megger test) on all motors at 500V. This must give greater than 10MΩ.								<input type="checkbox"/>
	Record Results:								
	415 Bus	RW	WB	BW	RE	WE			
	BE								
	Pump 1 cables	RW	WB	BW	RE	WE			
	BE								
	Pump 2 cables	RW	WB	BW	RE	WE			
	BE								
	GPO RE =								
33	For each pump tum the circuit breaker on and with personnel clear of all pumps, momentarily tum the control switch to ON and check for correct. Switch pump circuit breaker off.								<input type="checkbox"/>
34	Confirm that the Power Meter is configured for CT's and that the readings on the local display are appropriate.								<input type="checkbox"/>
35	Inspect telemetry and radio supply cable connections for correct polarity								<input type="checkbox"/>
36	Measure telemetry supply voltage and back-up battery voltage (should be 13.6V). Ensure appropriate voltages are detected as per electrical drawings								<input type="checkbox"/>

## JEA Water and Wastewater Standards 435 Booster Wastewater Pumping Stations

37	Check for mains voltage rated insulation on data cables where mixed with mains voltage cables	<input type="checkbox"/>
38	Check configuration of the PLC I/O against electrical drawings	<input type="checkbox"/>
39	Confirm that the telemetry unit has been configured	<input type="checkbox"/>
40	Confirm that the RTU calibration certificate has been supplied	<input type="checkbox"/>
41	Visual check of antenna installation, clearance from surroundings, mountings secure, and all cables connectors fitted and taped.	<input type="checkbox"/>
42	Check antenna mounted with weep hole to bottom	<input type="checkbox"/>
43	Check antenna bearing and polarization	<input type="checkbox"/>
44	Check for secure earth on radio coax surge protection (if applicable) and coax continuity	<input type="checkbox"/>
45	Check radio is marked with frequency in use as per electrical drawings	<input type="checkbox"/>
46	Check radio signal strength against fade margin figures	<input type="checkbox"/>
47	Check telemetry transmit-level to network device. Set as required by network device	<input type="checkbox"/>
48	Check telemetry receive level from network device, and set as required by the network device (or if not adjustable, ensure level is below telemetry threshold level)	<input type="checkbox"/>
	Monitor telemetry messages for errors	<input type="checkbox"/>
	Monitor radio audio clarity and set audio control off or to min volume	<input type="checkbox"/>
	Enable SCADA RTU and check telemetry unit is configured correctly	<input type="checkbox"/>
	Check that correct locks are fitted	<input type="checkbox"/>
	Monitor SCADA pull and error counters for satisfactory operation over a period of time until error rate is below 3%	<input type="checkbox"/>

OK

Rework Required

Comments:

---

Contractor Rep:

---

*Signature*   *Print name*

JEA Inspector:

---

*Signature*   *Print name*

JEA O&M Rep:

---

*Signature*   *Print name*

Commission Date:

---

*Signature*   *Print name*

# JEA Water and Wastewater Standards 435 Booster Wastewater Pumping Stations

## XIV.6.JEA INSTRUMENTATION COMMISSIONING CHECKLIST

Project Name: \_\_\_\_\_  
 Street/Intersection/Address: \_\_\_\_\_  
 \_\_\_\_\_

		Checked
1	Probe in Oil	<input type="checkbox"/>
2	Normal Switch State	<input type="checkbox"/>
3	Do latches on control panel work smoothly?	<input type="checkbox"/>
4	Are all connections tight?	<input type="checkbox"/>
5	Is the interior of the panel dry?	<input type="checkbox"/>
6	High water alarm light and horn activate with test button?	<input type="checkbox"/>
7	Horn silences with silence button?	<input type="checkbox"/>
8		<input type="checkbox"/>
9	All electrical components are locally available	<input type="checkbox"/>
10	<b>SCADA:</b>	<input type="checkbox"/>
11	Auto control	<input type="checkbox"/>
12	Hand/Manual control	<input type="checkbox"/>
13	Pump 1 status	<input type="checkbox"/>
14	Pump 1 start	<input type="checkbox"/>
15	Pump 2 status	<input type="checkbox"/>
16	Pump 2 start	<input type="checkbox"/>
17	Pump 3 status	<input type="checkbox"/>
18	Pump 3 start	<input type="checkbox"/>
19	Generator run status	<input type="checkbox"/>
20	Power fail	<input type="checkbox"/>
21	Generator fail	<input type="checkbox"/>
22	Battery fail	<input type="checkbox"/>
23	Transducer fail	<input type="checkbox"/>
24	High wet well level alarm	<input type="checkbox"/>
25	Station Intrusion	<input type="checkbox"/>
26	Turn off main switch. On the overview page of the SCADA confirm that the <i>POWER</i> changes from <i>NORMAL</i> to <i>FAIL</i> . And back again when the power is restored	<input type="checkbox"/>

## JEA Water and Wastewater Standards 435 Booster Wastewater Pumping Stations

27	For Each Pump:	Pump 1	Pump 2	Pump 3
28	Turn the pump from OFF to HAND. Check on the SCADA that LOCAL HOA changes from OFF to HAND.	<input type="checkbox"/>	<input type="checkbox"/>	<input type="checkbox"/>
29	Turn pump from HAND to AUTO. Check on the SCADA that LOCAL HOA changes from HAND to AUTO. NB: Pump may stop if not called by the controller.	<input type="checkbox"/>	<input type="checkbox"/>	<input type="checkbox"/>
30	Turn pump from AUTO to OFF. Check that LOCAL HOA changes to OFF and PUMP STATUS changes (or already has changed) back to STOP	<input type="checkbox"/>	<input type="checkbox"/>	<input type="checkbox"/>
31	Bridge out terminals for the seal fail probe on the pump until the seal fail relay is activated (may be referred to as "Pump Warning Healthy"). Check on the SCADA that PUMP WARNING changes from NORMAL to ALARM (FAIL) & the "SEAL FAIL" label is ON. Reset the relay and check that PUMP WARNING returns to NORMAL & the "Pump Warning" lamp is OFF. NB: This will not trip the pump.	<input type="checkbox"/>	<input type="checkbox"/>	<input type="checkbox"/>
32	Test operation of overload relay by winding down trip point. Check on the SCADA that the pump becomes unavailable and the pump status is FAILED & the "Drive Fault" lamp is ON. Reset the relay. Reset the alarm condition by switching pump to OFF, then AUTO. Check Alarm clears	<input type="checkbox"/>	<input type="checkbox"/>	<input type="checkbox"/>
33	Using a manual trip on the pump temperature sensor relay (may be referred to as "Pump Protection"). Ensure that the drive trips and becomes unavailable on the SCADA, and check that the "OVER TEMP" label is ON. Remove the trip condition and reset by pump inhibit OR switch pump to Off, then Auto.	<input type="checkbox"/>	<input type="checkbox"/>	<input type="checkbox"/>
34	With pumps running, ensure that the correct current readings are recorded in SCADA.	<input type="checkbox"/>	<input type="checkbox"/>	<input type="checkbox"/>
35	Check on the SCADA that Pump Hours Run is calculated and displayed correctly. NB: Change clock on PLC to test as value resets at 8 am.	<input type="checkbox"/>	<input type="checkbox"/>	<input type="checkbox"/>
36	Check on the SCADA that Pump Starts for the previous hour is calculated and displayed correctly.	<input type="checkbox"/>	<input type="checkbox"/>	<input type="checkbox"/>
37	Ensure that an appropriate "Fail to Start" time has been entered. Remove the Pump Start feedback from PLC and call the pump to run in Auto. After the "Fail to Start" time, ensure that an Alarm is raised, and the pump is FAILED & the "Drive Fault" lamp is ON. Reset the relay. Reset the alarm condition reset by pump inhibit OR switch pump to OFF, then Auto. Check that the pump is no longer FAILED & the "Drive Fault" lamp is OFF.	<input type="checkbox"/>	<input type="checkbox"/>	<input type="checkbox"/>
38	Ensure that an appropriate "Fail to Start" time has been entered. Remove the Pump Start feedback from PLC and call the pump to run in Auto. After the "Fail to Start" time, ensure that an Alarm is raised, and the pump is FAILED & the "Drive Fault" lamp is ON.	<input type="checkbox"/>	<input type="checkbox"/>	<input type="checkbox"/>



# *JEA Water and Wastewater Standards*

## *435 Booster Wastewater Pumping Stations*

---

Reset the relay. Reset the alarm condition reset by pump inhibit OR switch pump to OFF, then Auto. Check that the pump is no longer FAILED & the "Drive Fault" lamp is OFF.

---

Comments:

---

Contractor Rep:

---

*Signature    Print name*

JEA Inspector:

---

*Signature    Print name*

JEA O&M Rep:

---

*Signature    Print name*

Commission Date:

---

*Signature    Print name*

# JEA Water and Wastewater Standards 435 Booster Wastewater Pumping Stations

## XIV.7.JEA PUMP STATION BACK UP POWER DECISION TREES

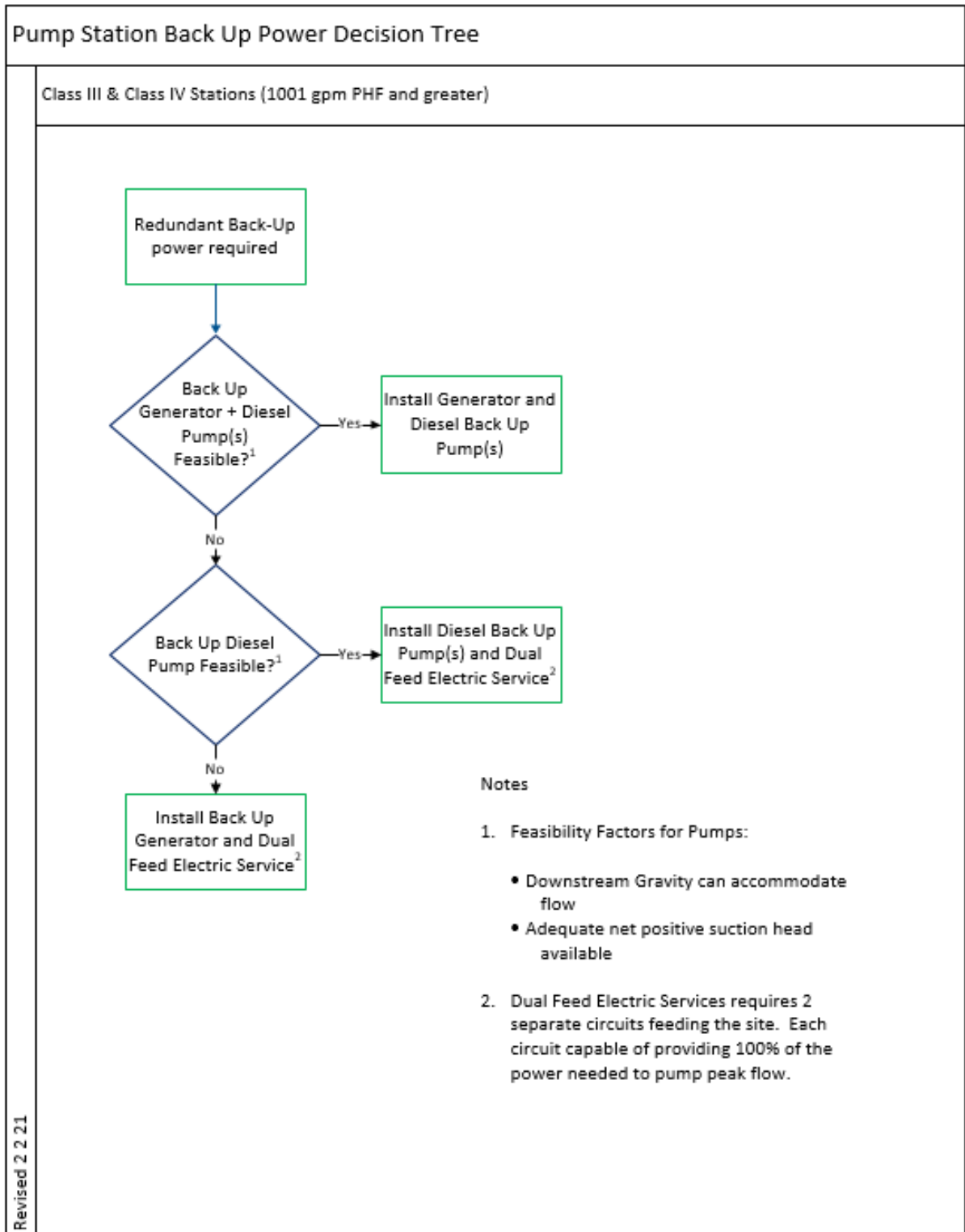

*Blank Page*

## 445 - OPERATING DATA SUBMISSION REQUIREMENTS

### I. GENERAL REQUIREMENTS

#### I.1. SCOPE OF WORK

This Section includes procedural requirements for compiling and submitting operation and maintenance data required to complete the project (excluding Development projects that do not receive cost participation).

#### I.2. RELATED WORK

I.2.1. Submittals are included in the Wastewater Specifications, Sections 400 Series.

I.2.2. Contract closeout is included in contract documents.

I.2.3. Warranties and Bonds are included in contract documents, and or in the Wastewater Specifications Section 400 Series, whichever is more stringent.

#### I.3. OPERATING MANUALS

I.3.1. Provide operation and maintenance instructions for all electrical, mechanical, and instrumentation & controls equipment furnished under various technical specifications Sections.

I.3.2. Six complete sets of operation and maintenance manuals approved by the JEA representative and JEA Operation Personnel covering all equipment furnished as required by the Specifications, shall be delivered at least 30 days prior to scheduled start-up directly to the JEA. One set of originals must be part of the six sets of operation and maintenance instructions required, including original manuals covering components manufactured by others.

I.3.3. An electronic copy of the manual will be provided with each hard copy submittal.

I.3.4. Separate manuals shall be provided for each type of equipment, or each Section number. Each manual shall contain the following specific requirements. Manuals that do not meet the requirements will be rejected and contractor and/or equipment supplier /manufacturer will bear all expenses to resubmit the manual to meet the following requirements.

I.3.5. The JEA representative will review Operation and Maintenance manuals submittals on operating equipment for conformance with the requirements of the applicable specification Section. The review will generally be based on the *O&M Manual Review Checklist* appended to this Section. Conformance must be confirmed to the JEA Representative by JEA Operation Personnel.

I.3.6. If during test and start-up of equipment, any changes were made to the equipment, provide copies (the number specified in paragraph 3.01.A.2) of as-built drawings or any other amendments for insertion in the final manuals. Submit the required number within 30 days of start-up and testing of the facility.

#### I.3.7. FORMAT AND MATERIALS

# *JEA Water and Wastewater Standards*

## *445 Operating Data Submission Requirements*

### I.3.7.1. Binders

- Commercial quality three ring binders with durable and cleanable plastic covers
- Maximum ring width capacity: 3 inches
- When multiple binders are used, correlate the data into related consistent groupings/volumes.

### I.3.7.2. Identification

Identify each volume on the cover and spine with typed or printed title "OPERATING AND MAINTENANCE INSTRUCTIONS". Include the following:

- Title of Project.
- Identify the general subject matter covered in the manual
- Identify structure(s) and/or location(s), as applicable
- Specification Section number
- 20 lb loose leaf paper, with hole reinforcement
- Page size: 8-1/2 inch by 11 inch
- Provide heavy-duty fly leafs (section separators), matching the table of contents, for each separate product, each piece of operating equipment, and organizational sections of the manual.
- Provide reinforced punched binder tab; bind in with text.
- Reduce larger drawings and fold to the size of text pages - but not larger than 11 inches x 17 inches - or provide a suitable clear plastic pocket (with drawing identification) for such folded drawings/diagrams.

### I.3.7.3. Contents

- A table of contents/Index
- Specific description of each system and components
- Name, address, telephone numbers and e-mail addresses of vendors and local service representatives
- Contractor and/or Equipment Supplier/manufacturer shall clearly strike out portions of manual that do not apply to the project. Manual will be rejected until inapplicable information is deleted and only applicable information is clearly indicated.
- Specific on-site operating instructions (including starting and stopping procedures)
- Safety considerations
- Project specific operational procedures
- Project specific maintenance procedures
- Manufacturer's operating and maintenance instructions – specific to the project
- Copy of each wiring diagram
- Copy of contractor's approved shop drawing
- List of spare parts and recommended quantities
- Product Data: Mark each sheet to clearly identify specific products and component parts and data applicable to installation. Delete inapplicable information.

# *JEA Water and Wastewater Standards*

## *445 Operating Data Submission Requirements*

- Drawings: Supplement product data to illustrate relations of component parts of equipment and systems, to show control and flow diagrams
- Provide logical sequence of instructions for each procedure, incorporating manufacturer's instructions specified.
- Equipment attributes sheet for submittal of name plate data
- Warranties and Bonds, as specified in the contract documents.

### **I.3.8. TRANSMITTALS**

- I.3.8.1. Prepare separate transmittal sheets for each manual. Each transmittal sheet shall include at least the following: the contractor's name and address, JEA's name, project name, project number, submittal number, description of submittal and number of copies submitted.
- I.3.8.2. Submittals shall be transmitted or delivered directly to the office of the JEA representative, as indicated in the contact documents or otherwise directed by the JEA.

### **I.3.9. MANUALS FOR EQUIPMENT AND SYSTEMS**

In addition to the requirements listed above, for each System, provide the following:

- I.3.9.1. Overview of system and description of unit or system and component parts. Identify function, normal operating characteristics and limiting conditions. Include performance curves, with engineering data and tests and complete nomenclature and commercial number of replaceable parts.
- I.3.9.2. Panel board circuit directories including electrical service characteristics, controls and communications and color coded wiring diagrams as installed.
- I.3.9.3. Operating procedures: include start-up, break-in and routine normal operating instructions and sequences; regulation, control, stopping, shut-down and emergency instructions; and summer, winter and any special operating instructions.
- I.3.9.4. Maintenance Requirements
- Procedures and guides for trouble-shooting; disassembly, repair, and reassembly instructions
  - Alignment, adjusting, balancing and checking instructions
  - Servicing and lubrication schedule and list of recommended lubricants
  - Manufacturer's printed operation and maintenance instructions
  - Sequence of operation by instrumentation and controls manufacturer
  - Original manufacturer's parts list, illustrations, assembly drawings and diagrams required for maintenance
- I.3.9.5. Control diagrams by controls manufacturer as installed (as-built)
- I.3.9.6. Contractor's coordination drawings, with color coded piping diagrams, as installed (as-built)

## *JEA Water and Wastewater Standards*

### *445 Operating Data Submission Requirements*

- I.3.9.7. Charts of valve tag numbers, with location and function of each valve, keyed to flow and control diagrams. Include equipment and instrument tag numbers on diagrams.
- I.3.9.8. List of original Manufacturer's spare parts and recommended quantities to be maintained in storage
- I.3.9.9. Test and balancing reports, as required
- I.3.9.10. Additional requirements as specified in individual product specification
- I.3.9.11. Design data for systems engineered by the contractor or its suppliers
- I.3.9.12. Equipment Attribute Information
- I.3.9.13. Equipment Attribute Worksheets as presented at the end of this Section shall be provided for all equipment meeting the asset definition as follows:
- I.3.9.14. Definition of an Asset:
  - I.3.9.14.1. Maintenance is recommended or required
  - I.3.9.14.2. Assets have a value greater than \$1,000
  - I.3.9.14.3. Assets are complete and usable, and perform a distinct function independently (i.e. they pump waste, remove solids, etc.)
- I.3.9.15. This asset definition is intended to give a general indication of which equipment must be included in the Equipment Attribute Worksheets. The JEA representative will provide the specific list of equipment that the contractor must provide information for.
- I.3.9.16. The information requirements are shown in detail in the table. The data requirements include nameplate data, manufacturer and supplier information, information specific to the type of equipment, and recommended preventive maintenance activities.
- I.3.9.17. An electronic copy of the Equipment Attribute Worksheets must be delivered in Excel format and submitted to the JEA representative on CD-ROM and submitted with the O&M manuals. It is not necessary to submit printed copies of the Equipment Attribute Worksheets.
- I.3.9.18. Manual For Materials And Finishes
  - In addition to the requirements listed above, for each material or finish, provide the following:
    - I.3.9.18.1. Building Products, Applied Materials and Finishes: Include product data, with catalog number, size, composition and color and texture designations. Provide information for re-ordering custom manufactured products.
    - I.3.9.18.2. Instructions for Care and Maintenance: Include Manufacturer's recommendations for cleaning agents and methods, precautions against

# ***JEA Water and Wastewater Standards***

## ***445 Operating Data Submission Requirements***

detrimental agents and methods and recommended schedule for cleaning and maintenance.

I.3.9.19. Moisture Protection and Weather Exposed Products: Include product data listing, applicable reference standards, chemical composition, and details of installation. Provide recommendations for inspections, maintenance and repair.

I.3.9.20. Additional Requirements: As specified in individual product specifications.

### **I.3.10. ELECTRONIC TRANSMISSIONS OF O&M MANUALS**

I.3.10.1. Unless otherwise approved by the JEA Representative and Operation Personnel, O&M manuals may not be transmitted by electronic means other than by CD-ROM. Electronic O&M manuals shall meet the following conditions:

I.3.10.2. The above-specified transmittal form is included.

I.3.10.3. All other requirements specified above have been met, including, but not limited to, coordination by the contractor, review and approval by the contractor.

I.3.10.4. The submittal contains no pages or sheets large than 11 x 17 inches.

I.3.10.5. With the exception of the transmittal sheet, the entire submittal is included in a single file.

I.3.10.6. Files are Portable Document Format (PDF) – with the printing function enabled.

I.3.10.7. The vendor provided equipment, sub-system, or system manuals shall be in PDF format, compliant with the Adobe PDF Specification Version 1.7. The manual shall be searchable image. The Optical Character Recognition of the image shall be at a 95% confidence level. The manuals shall be linked and bookmarked as follows:

- Provide links from all Table of Contents, List of Tables, List of Figures, etc., entries to the actual occurrence in the body of the manual.
- Create bookmarks for all linked Table of Content entries.

I.3.10.8. All drawings shall be in PDF format, compliant with the Adobe PDF Specification Version 1.7. The manual shall be PDF Searchable Image. The Optical Character Recognition of the image shall be at a 95% confidence level. The drawings shall be linked as follows:

- External links from the Drawing Index (if it exists) to each drawing.
- External links from references within drawings to other drawings.

I.3.10.9. When electronic copies are provided, transmit two hard-copy (paper) originals to the JEA Representative with an electronic copy on CD-ROM.

I.3.10.10. The electronic copy of the O&M manual must be identical in organization, format and content to the hard copies of the manual.

### **I.3.11. QUICK REFERENCE SHEETS FOR EQUIPMENT**



# ***JEA Water and Wastewater Standards***

## ***445 Operating Data Submission Requirements***

For each item of equipment furnished under Wastewater Specification, Section 400 Series provide the following:

- I.3.11.1. A minimum of one 8 ½ x 11-inch laminated quick reference sheet. Sheets shall be three hole punched and may be double sided.
- I.3.11.2. Each quick reference sheet shall include the following minimum information:
  - Safety Procedures
  - Brief descriptions of each piece of equipment and components
  - Starting and stopping procedures
  - Special operating instruction
  - Routine maintenance procedures
  - Calibration procedures
  - Pump curves
  - Trouble shooting procedures
  - Name, address, and telephone numbers of local service representative
- I.3.11.3. Provide three copies of quick reference sheets for review by the JEA representative.
- I.3.11.4. After quick reference sheets have been approved, provide four copies of laminated quick reference sheets to the JEA representative in one commercial coiled three-ring binder with durable and cleanable plastic cover.

### **I.4. SERVICES OF MANUFACTURERS' REPRESENTATIVE**

- I.4.1. All electrical, mechanical, and instrumentation & controls equipment furnished under various technical specifications Sections shall include the cost of a competent representative of the manufacturers of all equipment to supervise the installation, adjustment and testing of the equipment; and, to instruct the JEA Operation personnel on operation and maintenance. This supervision may be divided into two or more time periods to suit the Contractor's schedule and/or the JEA Operation personnel availability.
- I.4.2. See the detailed specifications for additional requirements for furnishing the services of Manufacturer's representatives.
- I.4.3. The Manufacturer's representative shall certify that the installation of the equipment is satisfactory; that the unit has been satisfactorily tested; that the equipment is ready for operation; and, that the operating personnel have been suitably instructed in the operation, maintenance, care, and safe operation of the equipment. The Equipment Manufacturer's Certificate of Installation, Testing, and Instruction attached to this Section shall be used for this certification.
- I.4.4. For other materials furnished under other specification Sections, furnish the services of approved representative(s) of the MANUFACTURER when, in the opinion of the JEA Operation Personnel, some evident product failure or malfunction makes such services necessary.

## **II. PUMP STATION STANDARD ATTRIBUTE WORKSHEETS**

## *JEA Water and Wastewater Standards 445 Operating Data Submission Requirements*

Pump station standard excel worksheets describing key asset information is required to be submitted with station as-builts in both paper and electronic form (excel). See [www.jea.com](http://www.jea.com) for the Pump Station Standard Attributes Excel Worksheets. Delete references and examples of Vendor-Manufacturer Worksheet, Local Representative Worksheet, Preventative Maintenance Worksheet, Preventative Maintenance Tasks, Assets Worksheet, Spare Parts Worksheet and JEA Standard Pump Station Asset Data Tables.

### **III. CHECKLISTS AND REPORTS**

# JEA Water and Wastewater Standards 445 Operating Data Submission Requirements

## III.1. O&M MANUAL REVIEW CHECKLIST

Project Name: \_\_\_\_\_

Street/Intersection/Address: \_\_\_\_\_

Manufacturer: \_\_\_\_\_

Equipment Submitted: \_\_\_\_\_

Specification Section: \_\_\_\_\_

Date of Submittal \_\_\_\_\_ Submittal Number: \_\_\_\_\_

Submitted By: \_\_\_\_\_

General Data:	OK	Not Adequate	Not Included
1 Are the Vendor's/Manufacturer's area representative's name, address, e-mail address and telephone number included?	<input type="checkbox"/>	<input type="checkbox"/>	<input type="checkbox"/>
2 Is the nameplate data for each component included?	<input type="checkbox"/>	<input type="checkbox"/>	<input type="checkbox"/>
3 Are all associated components related to the specific equipment included?	<input type="checkbox"/>	<input type="checkbox"/>	<input type="checkbox"/>
4 Is non-pertinent data crossed out or deleted?	<input type="checkbox"/>	<input type="checkbox"/>	<input type="checkbox"/>
5 Are drawings neatly folded and/or inserted into packets?	<input type="checkbox"/>	<input type="checkbox"/>	<input type="checkbox"/>
<b>Operations and Maintenance Data:</b>	<input type="checkbox"/>	<input type="checkbox"/>	
6 Is an overview description of the equipment and/or process included?	<input type="checkbox"/>	<input type="checkbox"/>	<input type="checkbox"/>
7 Does the description include the practical theory of operation?	<input type="checkbox"/>	<input type="checkbox"/>	<input type="checkbox"/>
8 Does each equipment component include specific details (design characteristics, operating parameters, control descriptions, and selector switch positions and functions)?	<input type="checkbox"/>	<input type="checkbox"/>	<input type="checkbox"/>
9 Are alarm and shutdown conditions clearly identified? Does it describe possible causes and recommended remedies?	<input type="checkbox"/>	<input type="checkbox"/>	<input type="checkbox"/>
10 Are step procedures for starting, stopping, and troubleshooting the equipment included?	<input type="checkbox"/>	<input type="checkbox"/>	<input type="checkbox"/>
11 Is a list of operational parameters to monitor and record for specific equipment included?	<input type="checkbox"/>	<input type="checkbox"/>	<input type="checkbox"/>
12 Is a proposed operating log sheet included?	<input type="checkbox"/>	<input type="checkbox"/>	<input type="checkbox"/>
13 Is a spare parts inventory list included for each component?	<input type="checkbox"/>	<input type="checkbox"/>	<input type="checkbox"/>
14 Is a lubrication schedule for each component included - or does it clearly state "No Lubrication Required"?	<input type="checkbox"/>	<input type="checkbox"/>	<input type="checkbox"/>
15 Is a maintenance schedule for each component included?	<input type="checkbox"/>	<input type="checkbox"/>	<input type="checkbox"/>
16 Is a copy of the warranty information included?	<input type="checkbox"/>	<input type="checkbox"/>	<input type="checkbox"/>
17 Are Equipment Attributes Sheets provided as specified?	<input type="checkbox"/>	<input type="checkbox"/>	<input type="checkbox"/>

*JEA Water and Wastewater Standards  
445 Operating Data Submission Requirements*

Is the submittal fully approved?

Yes

Rework Required

COMMENTS

---

---

---

---

---

---

Reviewed By:

*Signature*

*Print name*

*Date*

***JEA Water and Wastewater Standards  
445 Operating Data Submission Requirements***

**III.2. EQUIPMENT MANUFACTURER'S CERTIFICATE OF INSTALLATION, TESTING AND INSTRUCTIONS**

Project Name: \_\_\_\_\_

Contract No. \_\_\_\_\_

CDM Project No. \_\_\_\_\_

EQUIPMENT SPECIFICATION SECTION: \_\_\_\_\_

EQUIPMENT DESCRIPTION: \_\_\_\_\_

I \_\_\_\_\_, Authorized representative of  
(Print Name)

\_\_\_\_\_  
(Print Manufacturer's Name)

Here by CERTIFY that \_\_\_\_\_  
(Print equipment name and model with serial No.)

installed for the subject project [has] [have] been installed in a satisfactory manner, [has] [have] been satisfactorily tested, [is] [are] ready for operation, and that JEA assigned operating personnel have been suitably instructed in the operation, lubrication, and care of the unit[s] on Date: \_\_\_\_\_ Time: \_\_\_\_\_.

CERTIFIED BY: \_\_\_\_\_ DATE: \_\_\_\_\_  
(Signature of Manufacturer's Representative)

*JEA Water and Wastewater Standards  
445 Operating Data Submission Requirements*

III.3. JEA ACKNOWLEDGMENT OF MANUFACTURER'S INSTRUCTION

[I] [We] the undersigned, authorized representatives of the \_\_\_\_\_ and/or Operating Personnel have received classroom and hands on instruction on the operation, lubrication, and maintenance of the subject equipment and [am] [are] prepared to assume normal operational responsibility for the equipment:

\_\_\_\_\_  
DATE: \_\_\_\_\_

\_\_\_\_\_  
DATE: \_\_\_\_\_

\_\_\_\_\_  
DATE: \_\_\_\_\_

\_\_\_\_\_  
DATE: \_\_\_\_\_

EQUIPMENT ATTRIBUTE SHEETS

In order to facilitate the creation of asset records and their corresponding preventive maintenance schedules and activities in the Computerized Maintenance Management System (CMMS), information should be completed using the Excel template provided. Examples are provided in the Equipment Attribute Sheets template to help convey how the information should be completed. In addition, each worksheet in the Excel template is described below. The JEA REPRESENTATIVE will provide the CONTRACTOR a copy of the Excel spreadsheet for use in distributing to vendors/manufacturers for completion. The spreadsheet will be pre-populated with the list of assets for which information is required and the specific attributes that need to be completed.

*Blank Page*

## **446 - SPECIALTY COATINGS AND LININGS**

### **I. GENERAL REQUIREMENTS**

#### **I.1. SCOPE OF WORK**

A specialty coating or lining is required on the interior surfaces of all junction manholes (first manhole located adjacent to wet well), manholes which include a direct discharge from a force main or low pressure system, manholes which include a 24-inch or larger pipe and pump station wet wells, at a minimum. The Contractor shall furnish, install, and test the structures' coatings as shown on the drawings and specified herein. All applicable sections of the City of Jacksonville Standard Specifications and JEA Water and Wastewater Standards shall be considered part of this work. All references to Industry Standards (ASTM, ANSI, etc.) shall be to the latest revision unless otherwise stated. Only those materials included in the JEA Water and Wastewater Standards Manual shall be installed.

#### **I.2. WORKMANSHIP**

All work shall be proved to be in first class condition and constructed in accordance with the drawings and specifications. All defects disclosed by tests and inspections shall be remedied immediately by the Contractor at no expense to JEA.

#### **I.3. COVERAGE**

The lining/coating shall cover all include all interior concrete surfaces including the adjustment rings.

#### **I.4. PROJECT SCHEDULE AND COOPERATION**

The project schedule shall be established on the basis of working a normal work schedule including five days per week, single shift, eight hours per day or four days per week, single shift, ten hours per day. Unless approved otherwise by JEA, normal or general items of work, such as TV inspections, liner installation, density testing and final inspections, shall be scheduled during the normal work schedule. Due to operational and manpower limitations on the JEA systems, JEA will require the contractor to perform work outside of the normal work schedule. These operational and manpower limitations, including but not limited to, tie-in work (cut-in work or other tie-in work) and other phases of the work which may impact the continued (non-interruptible) service to existing JEA customers. The contractor shall plan and anticipate the cost impact of these system limitations and provide such work or services at no additional cost to JEA.

#### **I.5. SHOP DRAWING SUBMITTALS**

Actual catalog data, brochures and descriptive literature will not be required for items of standard usage which meet the requirements of Chapter X. and Chapter XI. of the JEA Water and Wastewater Standards Manual. Any specialty item not shown in this manual will require a complete shop drawing submittal. The Engineer may at any time require the Contractor to provide a complete detailed shop drawing submittal for any material which, in the Engineer's opinion, may not be in compliance with the JEA Water and Wastewater Standards.

#### **I.6. WARRANTY**

The liner manufacturer shall warrant the liner against defects for at least ten (10) years after the date of acceptance by JEA. Defects are defined as cracking, delamination or leaking. The warranty shall require the manufacturer to supply all necessary labor, materials, and equipment to repair defects to the satisfaction



# *JEA Water and Wastewater Standards*

## *446 Specialty Coatings and Linings*

of JEA. The Contractor and/or manufacturer shall not make any exemption or exception to the above stated conditions or warranty.

### **I.7. APPLICATION**

A list of approved liner materials is provided in the attached "Approved Materials Manual" (see page AS-602). Those liner materials not described below shall be manufacturers' standard and installed in accordance with the manufacturer's recommendations, at a minimum. Each liner listed (see Approved Materials Manual AS-602) is defined as either a hard shell liner, a polyurethane/fiberglass liner or a cementitious liner. Hard shell liners and polyurethane liners may be used on wet wells and all manholes, regardless of pipe sizes, and may be used on manholes which include a discharge from a wastewater force main or low pressure system. Hard shell liners or structural polyurethane is acceptable for structural liner applications where specified on the construction documents. If, in the opinion of the JEA representative, the manhole contains or will contain a very high concentration level of wastewater gas, then only a hard shell liner or polyurethane liner shall be utilized, regardless of the pipe sizes.

## **II. FIBERGLASS REINFORCED POLYESTER (FRP) INTERIOR LINING**

### **II.1. GENERAL**

FRP linings shall be manufactured by a JEA Standards approved provider. The work shall include the furnishing of an interior protective lining system including all necessary materials, equipment and tools as required for a complete installation. The completed system shall provide a waterproof, corrosion resistant liner to prevent any deterioration of concrete surfaces from hydrogen sulfide and other corrosive gases/acids produced by wastewater and to prevent infiltration. To ensure total unit responsibility, all materials and installation thereof shall be furnished by, and coordinated with, one supplier/manufacturer. The lining shall be provided in wet wells and manholes as designated on the drawings. The wet well shall have a flat slab concrete top lined with the fiberglass liner. FRP liner shall be one piece with no vertical or horizontal seams allowed. The liner shall be plain end. The FRP shall be fabricated in accordance with NBS PS 15-69, and shall consist of commercial grade poly ester resin, UV inhibitor, chopped strand, woven roving, and continuous reinforcement. Minimum liner thickness shall be half-inch for all diameter wells, and shall not have external ribs. Liner size shall be field verified by liner manufacturer's representative.

### **II.2. MATERIALS**

#### **II.2.1. RESIN**

The resins used shall be commercial grade polyester resins.

#### **II.2.2. REINFORCED MATERIALS**

The reinforcing materials shall be commercial Grade "E" type glass in the form of continuous roving, and chop roving, having a coupling agent that provides a suitable bond between the glass reinforcement and the resin.

#### **II.2.3. INTERIOR SURFACING MATERIALS**

The inner surface exposed to the chemical environment shall be a resin-rich layer of 0.010 to 0.020 inch thick. The inner surface layer exposed to the corrosive environment shall be followed with a minimum of two passes of chopped roving of minimum length 0.5 inch to a maximum length of 2.0 inches, and shall be applied uniformly to an equivalent weight of 3 oz. per square foot. Each pass of chopped roving shall be well rolled prior to the application of additional reinforcement. The combined thickness of the inner surface and interior layer shall not be less than 0.10 inch.

# *JEA Water and Wastewater Standards*

## *446 Specialty Coatings and Linings*

### **II.2.4. WALL CONSTRUCTION**

After the inner layer has been applied, the liner wall shall be constructed with chop and continuous strand filament wound manufacturing process which ensures continuous reinforcement and uniform strength and composition.

### **II.2.5. EXTERIOR SURFACE**

For a UV inhibitor, the resin on the exterior surface of the liner shall have a gray pigment added for a minimum thickness of .125 in.

### **II.2.6. FILLERS AND ADDITIVES**

Fillers, when used, shall be inert to the environment and liner construction. Sand shall not be acceptable as an approved filler. Additives, such as thixotropic agents, catalyst, promoters, etc., may be added as required by the specific manufacturing process to be used to meet the requirements of this standard. The resulting reinforced-plastic material must meet the requirements of this specification.

## **II.3. MANUFACTURING REQUIREMENTS**

### **II.3.1. GENERAL**

Liner cylinders shall be produced from glass fiber reinforced vinyl ester resin using a combination of chop and continuous filament wound process. Flat sheets for the underside of top slabs shall have the same

### **II.3.2. EXTERIOR SURFACE**

The exterior surface shall be relatively smooth with no sharp projections. Hand work finish is acceptable if enough resin is present to eliminate fiber show. The exterior surface shall be free of blisters larger than 0.5 in. in diameter, delamination, or fiber show.

### **II.3.3. INTERIOR SURFACE**

The interior surface shall be resin rich with no exposed fibers. The surface shall be free of crazing, delamination, blisters larger than 0.5 inch in diameter, and wrinkles of 0.125 inch or greater in depth. Surface pits shall be permitted if they are less than 0.75 inch in diameter and less than 0.0625 inch deep. Voids that cannot be broken with finger pressure and that are entirely below the resin surface shall be permitted if they are less than 0.5 inch in diameter and less than 0.0625 inch thick.

### **II.3.4. DIAMETER TOLERANCE**

Tolerance of the inside diameter shall be +/- 1% of the required liner diameter.

### **II.3.5. STIFFNESS**

The liner cylinder shall have the minimum pipe stiffness values shown in the table below when tested in accordance with ASTM D3753 8.5 (Note 1).

LINER LENGTH in FT.	PSI
3 – 6.5	0.75
7 – 12.5	1.26

# JEA Water and Wastewater Standards 446 Specialty Coatings and Linings

13 – 20.5	2.01
21 – 25.5	3.02
26 – 35	5.24

### II.3.6. SOUNDNESS

In order to determine soundness, apply an air or water pressure test to the liner test sample. Test pressure shall not be less than 3 psig or greater than 5 psig. While holding at the established pressure, inspect the entire liner for leaks. Any leakage through the laminate is cause for failure of the test. Refer to ASTM D3753 8.6.

### II.3.7. CHEMICAL RESISTANCE

When tested in accordance with ASTM D3753 8.7, the log of percent retention of each property after immersion testing when plotted against the log of immersion time, and extrapolated to 100,000 hours, shall assure retention of at least 50% of initial properties.

### II.3.8. PHYSICAL PROPERTIES

Item	Hoop Direction	Axial Direction
a. Tensile Strength (psi)	18,000	5,000
b. Tensile Modules (psi)	0.6 x 10e	0.7 x 10e
c. Flexural Strength (psi)	26,000	4,500
d. Flexural Modules (psi)	1.4 x 10e	0.7 x 10e
e. Compressive Strength (psi)	18,000	12,000

## II.4. TESTING

All tests shall be performed as specified in ASTM D3753 latest edition, Section 8. Test method D-790 (note 5) and test method D695. Each completed liner shall be examined for dimensional requirements, hardness and workmanship. All required ASTM D3753 testing shall be completed and records of all testing kept. Copies of test records shall be presented with shop drawings. As a basis of acceptance, the manufacturer shall provide an independent certification which shall consist of a copy of the manufacturer's test report, and be accompanied by a copy of the test results that the liner has been sampled, tested and inspected in accordance with the provisions of this specification and meets all its requirements.

## II.5. SHIPPING AND HANDLING

Do not drop or impact. Fiberglass liners may be lifted by a sling or "choker" connection around the center of the liner, and lifted as required. Use of chains or cables in contact with the liner surface is prohibited.

## II.6. INSTALLATION

The FRP liner shall be designed and fabricated as a non-load bearing liner to be installed inside a new manhole or wet well after installation of the manhole or wet well. The flat sheet liner placed on the underside of the manhole or wet well top slab shall be suitably anchored over the total contact surface area. The liner shall be designed to withstand normal shipping and installation loads. When properly installed inside a concrete manhole or wet well with properly designed and reinforced top slab, the manhole or wet well shall withstand an ASSHTO H-20 loading and all other applicable soil and hydrostatic loads. The annular space

# *JEA Water and Wastewater Standards*

## *446 Specialty Coatings and Linings*

between the existing concrete and the new liner shall be filled with a high strength, non-shrink, cementitious grout for non-structural units or cementitious grout for structural liners, which shall leave no void between the liner and the existing structure. The annular space shall be no wider than 3-inches.

### **II.6.1. JOINTS**

Following field installation, the manhole or wet well FRP joints between top slab and walls shall be sealed in the field by persons certified by the liner manufacturer and shall be done in accordance with the recommendations of the liner manufacturer. Joints shall be sealed using the following method:

II.6.1.1. Grind sand and clean thoroughly the surface to be joined or repaired.

II.6.1.2. To prepare resin, mix one pint of resin with 1/3 ounce of catalyst. (Note: To decrease set up time, increase amount of catalyst. To increase set up time, decrease amount of catalyst.)

II.6.1.3. Coat the joint or the repair area with the prepared resin. Thoroughly wet a section of coarse mat with the prepared resin. Apply the wet mat to the repair area. It is very important to roll out all air pockets from the wet mat. Wet a section of fine mat and apply in the same fashion, being sure to roll out all air pockets. Repeat again until the area has been completely covered. Stagger your wet mat applications by at least one inch each time.

### **II.6.2. CONNECTIONS**

Openings for pipe connections will be core drilled in the field. Pipes shall be placed through concrete wet well and fiberglass liner in the locations indicated on the drawings. Pipes shall then be grouted in place with the grout filling the entire void and being as thick as the concrete wet well. The pipe on the interior of the wet well shall be fiber glassed to the fiberglass liner. To fiberglass the PVC or ductile iron pipe to the fiberglass liner, the surface to be fiber glassed must first be sanded. In the case of ductile iron pipe, the protective coating on the exterior of the pipe must be removed and then the pipe sanded. After sanding and cleaning the area to be fiber glassed, apply a coat of JEA Standards approved primer. When the primer becomes tacky, begin normal installation of the fiberglass, taking care to roll out all of the air pockets. All field fiber glassing must be accomplished by a lining manufacturer certified installer. Submit certification with shop drawings.

### **II.7. REPAIRS**

Any liner repair must meet all requirements of this specification.

### **II.8. EXISTING MANHOLES AND WET WELLS**

Where an existing manhole or wet well is to be lined with an FRP liner, all of the requirements in Section 3, of these specifications, remain applicable except that where the vertical liner riser sections are to be cast with the concrete, a single monolithic liner shall be installed. The annular space between the existing concrete and the new liner shall be filled with a high strength, non-shrink, cementitious grout which shall leave no void between the liner and the existing structure. All existing liners must be removed from the existing structure and the structure must be thoroughly cleaned in accordance with ASTM D4258 and abrasive blasting in accordance with ASTM D4259 prior to installation of the fiberglass liner.

#### **II.8.1. MANHOLES**

# *JEA Water and Wastewater Standards*

## *446 Specialty Coatings and Linings*

Manholes shall have cone section removed to install liner in accordance with Section 3.8. Install new fiberglass lined concrete cone section and replace existing concrete or brick cone section as indicated on the drawings. Brick top of manhole with acid-resistant, non-shrink mortar or use concrete grade rings mortared in place with acid resistant, non-shrink mortar.

### II.8.2. WET WELLS

Wet wells shall have top slab and piping removed to install liner in accordance with Section 3.8. Install new top slab with fiberglass liner cast with concrete. Seal joint between top slab liner and wall liner in accordance with Section 3.6.1. Install pipe connections in accordance with Section 3.6.2.

## III. SPECTRASHIELD

### III.1. GENERAL

The work shall include the furnishing and installation of an interior protective coating system including all necessary materials, equipment and tools as required for a complete installation. The completed system shall provide a waterproof, corrosion resistant liner to prevent any deterioration of concrete surfaces from hydrogen sulfide and other corrosive gases/acids produced by wastewater and to prevent infiltration. To ensure total unit responsibility, all materials and installation thereof shall be furnished by, and coordinated with, one supplier/manufacturer.

### III.2. MATERIALS AND EQUIPMENT

III.2.1. The materials to be utilized in the lining of concrete structures shall be designed and manufactured to withstand the severe effects of hydrogen sulfide in a wastewater environment.

III.2.2. Abrasive blasting equipment shall be suited to completely remove deteriorated concrete and hard contaminants from the existing concrete surfaces. Contaminant unit to capture spent abrasive material shall be provided unless otherwise approved by the Engineer.

III.2.3. Equipment for installation of lining materials shall be high quality grade as recommended by the manufacturer.

III.2.4. The lining system to be utilized shall be a multi-component stress panel liner system as described below:

Installation	Liner
a. Moisture Displacement Barrier	Primer
b. Moisture Barrier	Modified Polymer
c. Surfacer	Polyurethane/Polymeric Blend Foam
d. Final Corrosion Barrier	Modified Polymer

III.2.5. Primer shall be 100% solids.

III.2.6. Modified polymer shall be sprayed, solvent-free, two-component polymeric, moisture/chemical barrier specifically developed for the corrosive environment of wastewater.

## JEA Water and Wastewater Standards 446 Specialty Coatings and Linings

III.2.7.

TYPICAL CHEMICAL ANALYSIS	
<b>"A" Component</b>	
Viscosity, 77°F, cps, ASTM D-11638	400
Physical State	Liquid
Color	Clear
Hygroscopicity	Reacts with Water
<b>"B" Component</b>	
Viscosity, 160°F, cps, ASTM D-1638	400
Physical State	Liquid
Color	Flamingo Pink
Non-Volatile	100%
<b>Reaction Profile (100 grams, 175°F Sample)</b>	
Gel Time, seconds	1-2
Tack Free Time, seconds	15
Cure Time, seconds	30
<b>Processing</b>	
A System / B System, volume ratio	1.00/1.00
<b>Typical Physical Properties</b>	
Tensile Strength, PSI	>1500
Elongation, %	125
Tear Strength, PSI	350
Shore D Hardness	55
100% Modulus, PSI	>1500

III.2.8. Polyurethane/polymeric blend foam shall be 100% CFC/HCFC free, low viscosity, two component, fire resistant, rigid structural filler.

TYPICAL CHEMICAL ANALYSIS	
<b>"A" Component</b>	
Viscosity, 77°F, cps, ASTM D-11638	200
Physical State	Liquid
Color	Dark Brown
Hygroscopicity	Reacts with Water and evolves CO2 gas

# JEA Water and Wastewater Standards

## 446 Specialty Coatings and Linings

<b>"B" Component</b>	
Viscosity, 77°F, cps, ASTM D-1638	1800
Physical State	Liquid
Color	Tan
Hygroscopicity	Absorbs water rapidly thus changing ratio
<b>Reaction Profile (100 grams, 77°F Sample)</b>	
Cream Time, seconds	1-4
Tack Free Time, seconds	5-8
Rise Time, seconds	6-10
<b>Processing</b>	
A System / B System, volume ratio	1.00/1.00
<b>Typical Physical Properties</b>	
Density, nominal core, lb./ft <sup>3</sup> ASTM D-1622 @ 74°F	4 1/2 – 5 1/2
Compression Strength, ASTM D-1621 @ 74°F parallel to rise, PSI	105 – 110
Closed Cell Content, % ASTM D-1940 @ 74°F	Over 90
Shear Strength, PSI ASTM C-273 @ 74°F	225 – 250

III.2.9. Total thickness of multi-component stress panel liner shall be a minimum of 500 mils, shall sustain a 300 PSI pull test and be approved by JEA standards.

### III.3. SURFACE PREPARATION

Abrasive blasting equipment shall remove all deteriorated concrete, hard contaminants, localized micro-organisms and gas contaminants from the concrete walls, floor, ceiling, and other concrete structures. Final product shall be a cleaned, exposed and virgin concrete aggregate ready for rehabilitation material. Abrasive blasting equipment shall be suited to completely remove deteriorated concrete and hard contaminants from the existing concrete surfaces. Containment unit to capture spent abrasive material shall be provided unless otherwise approved by the Engineer.

III.3.1. After completion of surface preparation, blasting phase, perform the seven point checklist, which is the inspection for:

- Leaks
- Cracks
- Holes
- Exposed Rebar

# *JEA Water and Wastewater Standards*

## *446 Specialty Coatings and Linings*

- Ring and Cover Condition
- Invert Condition
- Inlet and Outlet Pipe Condition

III.3.2. After the defects in the structure have been identified, repair all leaks with grout designed for use in field sealing of ground water. Severe cracks shall be repaired using a urethane based chemical sealant. Product to be utilized shall be as approved by the Engineer prior to installation. Repairs to exposed rebar, defective pipe penetrations or inverts, etc. shall be repaired utilizing non-shrink grout or Engineer approved alternate method.

III.3.3. Prior to installation of final liner material, if required, re-blast the entire structure and remove all abrasive materials.

### **III.4. MATERIAL INSTALLATION**

III.4.1. The limits of the corrosion protection system shall be all exposed concrete surfaces including walls, tap sections, risers, etc., unless otherwise approved by the Engineer.

III.4.2. Application of multi-component system shall be in strict accordance with the manufacturer's recommendations. Final installation shall be a minimum thickness of 500 mils. A permanent identification number and date of work performed shall be affixed to the structure in a readily visible location.

III.4.3. Provide final written report to Engineer detailing the location, date of report, and description of repair or original installation.

### **III.5. INSPECTION AND REPAIRS**

Final concrete structure corrosion protection system shall be completely free of pinholes or voids. Entire exposed concrete surface shall be protected with corrosion protection system. Liner thickness shall be the minimum thickness described above. All defects identified during inspection such as pinholes, low film millage, etc. shall be repaired with same material and to same thickness as required of original installation.

## **IV. GREEN MONSTER™**

### **IV.1. GENERAL**

The work shall include the furnishing and installation of an interior protective coating system including all necessary materials, equipment and tools as required for a complete installation. The completed system shall provide a waterproof, corrosion resistant liner to prevent any deterioration of concrete surfaces from hydrogen sulfide and other corrosive gases/acids produced by wastewater and to prevent infiltration.

### **IV.2. MATERIALS AND EQUIPMENT**

IV.2.1. All materials used within the Green Monster™ system shall be highly resistant to hydrogen sulfide in the wastewater environment.

IV.2.2. Water blasting equipment shall be no less than 4000 psi and sandblasting equipment shall deliver enough pressure to remove all deteriorated concrete in the structure providing a substrate free of loose material.



## *JEA Water and Wastewater Standards* *446 Specialty Coatings and Linings*

- IV.2.3. High early strength calcium aluminate cementitious concrete shall be used to structurally rebuild structure also providing an esthetically smooth brush finished surface.
- IV.2.4. All spray equipment shall be plural component and be capable of monitoring pressures and temperatures of the coating ensuring a quality
- IV.2.5. All products used in the Green Monster™ system shall be approved and installed by manufacturer's trained personnel only. View product specifications below:

**IV.2.6. PRIMER SPECIFICATIONS**

Typical Properties (1:1 by volume.):

Tensile Strength, PSI - ASTM D638	4500 psi
Elongation, % -STM D638	6 %
Compressive Strength, NEAT - ASTM D695	3800
Compressive Strength, SAND - ASTM D695	4450
Shrinkage	None
Exudation	None
Bond Strength, psi. - ASTM D4541	1200 psi
Hardness, Shore D - ASTM D2240	71
Color	Amber
Viscosity, cps, neat	25 cps
Tack Free @ 72° F	10 min
Final Cure @ 72° F	20 min

- IV.2.7. Primer shall have an extremely low viscosity allowing it to penetrate deep into the pours of the brushed concrete for permanent bonding.
- IV.2.8. Shall only be spray-applied and fully cure in 20 minutes or less without experiencing any shrinkage.
- IV.2.9. Concrete substrate shall be heated and surface temperature decreasing during the application of Green Monster™ Primer.
- IV.2.10. Green Monster™ Liner shall display excellent chemical resistance, thermal stability, and maintain flexible characteristics preventing cracking which may allow wastewater gases to attack the substrate.

Typical Physical Properties

Tensile Strength, PSI - ASTM D412	4500 psi
Elongation, % - ASTM D412	460 %
100% Modulus - ASTM D412	1460

## *JEA Water and Wastewater Standards 446 Specialty Coatings and Linings*

200% Modulus - ASTM D412	1960
300% Modulus - ASTM D412	2650
Tear Strength, PSI - ASTM D624	570 psi
Hardness, Shore A - ASTM D2240	98
Hardness, Shore D - ASTM D2240	71
Flexibility, 1/8" Mandrel - ASTM D1737	Pass
Flash Point, °F PENSKEY-MARTIN	>200
Taber Abrasion, MG LOSS ASTM D4060	17.0 mg
CS 17 WHEELS	1KG, 1000 REVS
Viscosity B-Side (75°F), CPS	650
Viscosity A-Side (75°F), CPS	350
A-Side Hose Temperature °F	140-160
B-Side Hose Temperature °F	140-160
BLOCK TEMPERATURE °F	160

### IV.2.11. ADHESION RESULTS

ASTM D-4541 Patti Tester	PSI
Concrete (direct to concrete) (NO PRIMER)	>350PSI, Glue Failure
Concrete, Green Monster Primer	600 PSI, Epoxy Glue Failure
Carbon Steel (direct)	900 PSI

### IV.2.12. TYPICAL PROCESSING PROPERTIES

Gel Time, Seconds	20
Tack Free Time Seconds	45
Volume Ration V:V	1:1

IV.2.13. Concrete restoration shall be between .25 and 3 inches whichever is required to return the surface to the original thickness. In the case of minor deterioration and spalding, a Green Monster™ system approved cementitious concrete shall be used as a resurfacer. Once the proper concrete restoration has been achieved, Green Monster™ will be applied at 100 mils. Product shall be Green Monster™ Liner

### IV.3. SURFACE PREPARATION

- IV.3.1. The structure will be solid plugged or flow-through plugs will be used to control flow coming into the work area.
- IV.3.2. Preparation will begin by sandblasting the entire substrate preparing the surface so that it is structurally intact, clean of all corrosion, and provided with a good profile.

# *JEA Water and Wastewater Standards*

## *446 Specialty Coatings and Linings*

- IV.3.3. After sandblasting is completed, the surface area will be power washed at 4000 psi ridding the substrate of all dust, sand, and loose debris.
- IV.3.4. All solids and water will be removed from the work site along with other debris.
- IV.3.5. Active infiltration will be injection grouted.
- IV.3.6. A cementitious calcium aluminate concrete will be applied to the entire substrate to be coated, in most cases the entire surface will be structurally built up .25 to 3 inches thick providing a smooth brushed finish. Thicker applications may apply where there is more deterioration of the existing structure.
- IV.3.7. The work area will be completely dried using in-direct heat lowering the moisture content of the substrate.
- IV.3.8. Green Monster™ Primer will be applied to the dry and cooling substrate providing maximum adhesion and sealing the porous concrete.
- IV.3.9. Green Monster™ Liner shall be spray applied at a 100 mil thickness. This will be sprayed onto the ring of the structure down to the coating of the bench in manholes and the entire bottom of other structures.

#### **IV.4. MATERIAL INSTALLATION**

- IV.4.1. The limits of the corrosion protection system shall be all exposed concrete surfaces including walls, pipe penetrations, risers, etc., unless otherwise approved by Engineer.
- IV.4.2. Application of the Green Monster™ Liner System shall be in strict accordance with the manufacturer's recommendations.
- IV.4.3. All material installed must be holiday tested for pinholes. Either an approved manufacturer representative can approve the test or it is preferred to have an inspector from the utility on location to sign off on the test procedure.

#### **IV.5. INSPECTION AND REPAIRS**

Final concrete structure corrosion protection system shall be completely free of pinholes or voids. Entire exposed concrete surface shall be protected with corrosion protection system. Liner preparation and thickness shall meet what is stated above. All defects identified during inspection such as pinholes, thin film millage, etc. shall be repaired with same material and to same thickness as required of original installation.

### **V. SEWPERCOAT**

#### **V.1. GENERAL**

The work shall include the furnishing and installation of an interior protective coating system including all necessary labor, materials, equipment and tools as required for a complete installation. Coating shall be 100% calcium aluminate mortar as manufactured by SewperCoat. This liner material shall provide a corrosion resistant liner to prevent any deterioration of concrete surfaces from hydrogen sulfide and other corrosive gases/acids produced by wastewater and to prevent infiltration. To ensure total unit responsibility, all materials and installation thereof shall be furnished by, and coordinated with, one supplier/manufacturer

# JEA Water and Wastewater Standards

## 446 Specialty Coatings and Linings

### V.2. PROPERTIES

The lining system to be utilized shall be 100% calcium aluminate cement with 100% calcium aluminate aggregate and with the following minimum performance parameters:

PARAMETER	12 HRS	24 HRS	7 DAYS	28 DAYS
Compressive Strength, psi (ASTM C945)	>6000	>7000	>9000	>9000
Flexural Strength, psi (ASTM C293)	>1000	>1300	>1400	>1400
Shrinkage at 90% Humidity (ASTM C596)		>0.02	>0.04	>0.06
Freeze/Thaw after 300 Cycles (ASTM C666)	No damage	No damage	No damage	No damage
Tensile Strength (ASTM C900 modified)	200 – 230 psi Tensile Strength			
Air Void Content 7 Days (ASST. C457)	3%			
Specific Gravity/Absorption Test 7 Days (ASTM C642)	4-5%			

### V.3. MATERIALS

Mortar furnished under this specification shall be a pre-packaged mortar, including all cement, aggregate, and any required admixtures or fibers. It is the intent of this specification that the Contractor only be required to add the proper amount of potable water so as to produce a mortar suitable for pneumatic application. Typical package weights shall not be less than 50 pounds.

### V.4. INSTALLATION

V.4.1. High pressure water or sand spray blasting equipment shall remove all deteriorated concrete, (minimum of 3500 psi), hard contaminants, localized micro-organisms and gas contaminants from the concrete walls, floor, ceiling, and other concrete structures. Final product shall be a cleaned, exposed and virgin concrete aggregate ready for rehabilitation material. The blasting equipment shall be suited to completely remove deteriorated concrete and hard contaminants from the existing concrete surfaces. Containment unit to capture spent abrasive material shall be provided unless otherwise approved by the Engineer.

V.4.2. After completion of surface preparation, blasting phase, perform the following seven point checklist, which is the inspection for:

- Leaks
- Cracks
- Holes
- Exposed Rebar
- Ring and Cover Condition

## *JEA Water and Wastewater Standards 446 Specialty Coatings and Linings*

- Invert Condition
  - Inlet and Outlet Pipe Condition
- V.4.3. After the defects in the structure have been identified, repair all leaks with a chemical or hydraulic sealant designed for use in field sealing of ground water. Severe cracks shall be repaired using a urethane based chemical sealant. Product to be utilized shall be as approved by the Engineer prior to installation. Repairs to exposed rebar, defective pipe penetrations or inverts, etc. shall be repaired utilizing non-shrink grout or Engineer approved alternate method.
- V.4.4. Materials shall be sprayed applied by either a wet gunning (low pressure spray) or dry gunning (shotcrete) method and shall conform to the "Suggested Manufacturer Procedures" document as supplied by the manufacturer. The equipment shall be clean and free of any hydrated or unhydrated Portland cement to prevent acceleration of SewperCoat. To ensure a good bond, the newly blasted surface shall be thoroughly moistened with water prior to application. The material shall be applied in one or more layers to such total thickness as required. A minimum of one-half inch shall be applied. After spraying, the material shall be brushed or trowel finished. A moist curing environment is typically activated by replacing the manhole lid cover. If not, a heavy application of curing compound shall be applied.

## **448 - EXISTING CONCRETE PREPARATION AND REPAIR**

### **I. GENERAL REQUIREMENTS**

#### **I.1. SCOPE OF WORK**

The scope of work shall consist of removing all the coating and deteriorated concrete as shown and described in the drawings, including saw cutting the perimeter of the repair area, Preparing the surface of the concrete for the repair, including abrasive cleaning, cleaning of existing reinforcement, and applying bonding agent to the surface. Supplying materials and the mixing and placing of concrete repair mortar or concrete as shown and described on the drawings and in this specification including vibrating, finishing and curing. Supplying, fabricating, constructing, maintaining and removing temporary works, including false work and formwork. The quality control (QC) testing of all materials.

#### **I.2. REFERENCES AND RELATED SPECIFICATIONS**

All reference standards and related specifications shall be current issue unless otherwise stated.

- ACI 546R Concrete Repair Guide
- ACI 210R, Erosion of Concrete in Hydraulic Structures
- ACI 318, Building Code Requirements For Structural Concrete
- ACI 117, Standard Tolerances for Concrete Construction and Materials
- ACI 305, Hot Weather Concreting
- ACI 301, Cold Weather Concreting
- ACI 350, Environmental Concrete Structures
- ACI RAP, Bulletin 1-Strutural Crack repair by Epoxy Injection
- ACI RAP, Bulletin 2-Crack repair by gravity feed with Resin
- ACI RAP, Bulletin 3-Spall repair by Low-Pressure Spraying
- ASTM: The published standards of the American Society for Testing and Materials, West Conshohocken, PA.
- ASTM D638 - Tensile Properties of Plastics.
- ASTM D790 - Flexural Properties of Unreinforced and Reinforced Plastics.
- ASTM D695 - Compressive Properties of Rigid Plastics.
- ASTM D4541 - Pull-off Strength of Coatings Using a Portable Adhesion Tester.
- ASTM D7234 - Pull-Off Adhesion Strength of Coatings on Concrete Using Portable Pull-Off Adhesion Testers.
- ASTM D4787 Standard Practice for Continuity Verification of Liquid or Sheet Linings Applied to Concrete Substrates.
- ASTM D2584 - Volatile Matter Content.
- ASTM D543 - Resistance of Plastics to Chemical Reagents.
- ASTM D4258 - Standard Practice for Surface Cleaning Concrete.
- ASTM D4259 - Standard Practice for Abrading Concrete.
- ASTM C109 - Compressive Strength Hydraulic Cement Mortars.

# *JEA Water and Wastewater Standards*

## *448 Existing Concrete Preparation and Repair*

- ASTM C579 - Compressive Strength of Chemically Setting Silicate and Silica Chemical Resistant Mortars.
- ICRI: The published standards of the International Concrete Repair Institute, Des Plaines, IL.
- ICRI Technical Guideline No. 03732 - Selecting and Specifying Concrete Surface Preparation for Sealers, Coatings, and Polymer Overlays.
- ICRI Guide Line No. 310.1R-2008 - Guide for Surface Preparation for the Repair of Deteriorated Concrete Resulting from Reinforcing Steel Corrosion
- NACE: The published standards of National Association of Corrosion Engineers (NACE International), Houston, TX.
- NACE RPO 188-99 Discontinuity (Holiday) Testing of New Protective Coatings on Conductive Substrates.
- SSPC: The published standards of the Society of Protective Coatings, Pittsburgh, PA.
- SSPC-SP 1 - Solvent Cleaning
- SSPC-SP 5 - White Metal Blast Cleaning
- SSPC-SP 10 - Near White Metal Blast Cleaning
- SSPC-SP 12 Surface Preparation and Cleaning of Metals by Water jetting prior to Recoating.
- SSPC SP-13/NACE No. 6 - Surface Preparation of Concrete.
- SSPC-PA 9 - Measurement of Dry Coating Thickness on Cementitious Substrates Using Ultrasonic Gages.

### **I.3. SUBMITTALS**

The Contractor shall submit the following to the Engineer, for approval, prior to the Contractor proceeding with the work.

- Shop Drawings and proposed procedures.
- Product data sheets and installation procedures for proposed concrete repair mortar(s), reinforcing materials, fasteners and bonding agents
- Detailed design notes, calculations and Shop Drawings for any temporary shoring, including formwork.

## **II. PRODUCTS**

### **II.1. REINFORCING MATERIALS**

II.1.1. Reinforcing Bars: ASTM A615, Grade 60

II.1.2. Stainless Steel Mesh: T-316 stainless steel, 0.105" wire diameter, 1" mesh with plain weave.

### **II.2. CONCRETE MATERIALS**

II.2.1. High Strength Non-Shrink Grout: ASTM C1107; premixed compound consisting of non-metallic aggregate, cement, water reducing and plasticizing agents.

- Minimum Compressive Strength @ 24 hours: 2,000 psi
- Minimum Compressive Strength @ 28 days: 6,000 psi

# *JEA Water and Wastewater Standards*

## *448 Existing Concrete Preparation and Repair*

- II.2.2. Vertical and Overhead Repair Mortars: Trowel applied, high strength, shrinkage compensated cement base mortar.
- II.2.3. Horizontal Repair Mortars: Trowel applied, high strength, cement base mortar.
- II.2.4. Extending Aggregate: 3/8" diameter, non-reactive, pea gravel and as specified by mortar/grout manufacturer.

### **II.3. FASTENERS**

Powder actuated, 0.145" shank diameter, 316 stainless steel pins with 1" metal washer. 1.5" minimum length, 1" embedment. Use low velocity shot.

### **II.4. BONDING AGENT**

This product may also be used to prime reinforcing steel in accordance with mortar repair manufacturer requirements.

## **III. SURFACE PREPARATION**

### **III.1. PROTECTION BARRIERS**

The Contractor shall supply and erect appropriate protection barriers/shrouding or other approved means as required to protect all personnel, equipment, and existing improvements, and provide the appropriate PPE for personnel to perform their required tasks.

### **III.2. CLEANING AND DISPOSAL**

- III.2.1. Contractor shall pump out all liquids and remove all solids from the designated areas. All liquids and solids shall be disposed of by the Contractor according to Federal, State, and Local laws.
- III.2.2. The designated areas shall be cleaned using a high-pressure water spray (minimum 1200 psi). A solution of 10% hypochlorite/water or equivalent disinfecting solution shall be sprayed on all walls, floors, and overheads and left wet for 15 minutes minimum for disinfection. All walls, floors, and overheads shall be rinsed with clear, clean water while the disinfection solution is still wet. All liquids and solids shall be pumped out and disposed of by the Contractor according to Federal, State, and Local laws. Care must be taken not to allow the disinfection solution and wash water to enter the plant waste stream.
- III.2.3. Prior to blasting, a meeting with the coating manufactures representative, the Contractor, and the Owner shall be conducted to agree upon the surface preparation required for installation of the coating.
- III.2.4. All coatings, hard contaminants, localized micro-organisms, gas contaminants, and deteriorated concrete shall be removed from the walls, floor, overhead and other concrete structures as designated by high pressure hydro blasting (40,000 psi), mechanical methods, or abrasive blasting. The Contractor shall adhere to the requirements of SSPC-SP 13/NACE 6. Final product shall be cleaned, exposed and virgin concrete aggregate ready for rehabilitation material. At the 50% completion of blasting, a meeting with the coating manufactures representative, the Contractor, and the Owner shall be conducted to inspect the surface preparation.

### **III.3. CONCRETE REPAIRS AND PREPARATION**



# *JEA Water and Wastewater Standards*

## *448 Existing Concrete Preparation and Repair*

- III.3.1. Prior to any concrete repairs, the Contractor shall remove all dust, dirt, water and debris from the surface of the concrete in accordance with repair product manufacturers recommendations and requirements.
- III.3.2. After defects in the structure have been identified, repair all areas in accordance with this section.
- III.3.3. Prior to the installation of coatings, if required by the coating manufacturer, re-blast the entire structure to provide the proper surface profile, and remove all blasting residue. A meeting with the coating manufactures representative, the Contractor, and the Owner shall be conducted to inspect the surface preparation prior to installation of the coating.
- III.3.4. Coatings shall be applied in accordance with Section 446 and Section 447 as required.

### **IV. CONCRETE REMOVAL**

#### **IV.1. PREPARATION**

All areas of unsound concrete to be repaired will be marked by the Contractor once he has cleaned the existing surface for the Owner/Engineer's review prior to proceeding.

#### **IV.2. CUTTING/REMOVING**

- IV.2.1. The Contractor shall saw cut the outer perimeter of the repair areas. Feathered edges will not be acceptable.
- IV.2.2. The Contractor shall take care to ensure that the existing reinforcing steel is not damaged during saw cutting.
- IV.2.3. Any damage caused by the Contractor to any portion of the structure not intended for repair shall be repaired by the Contractor, at the Contractor's expense, to the satisfaction of the Engineer and Owner.
- IV.2.4. The Contractor shall remove all areas of unsound concrete by chipping, hydro demolition, mechanical removal, or other approved methods. The Contractor shall exercise caution and take care not to damage any existing reinforcing steel intended to remain in place.

### **V. TYPES OF REPAIRS**

All repair areas shall be neatly formed to restore the original geometry of the concrete structure (channel, slab, wall, slab, etc.).

#### **V.1. TYPE A REPAIR: PARTIAL DEPTH REPAIR – UP TO 0.5"**

Repairs up to 0.5" in depth shall be cleaned and unsound concrete removed. No cementitious repair shall occur. However, coating material thickness shall be increased to create a uniform wall surface and maintain channel flowline.

# JEA Water and Wastewater Standards

## 448 Existing Concrete Preparation and Repair

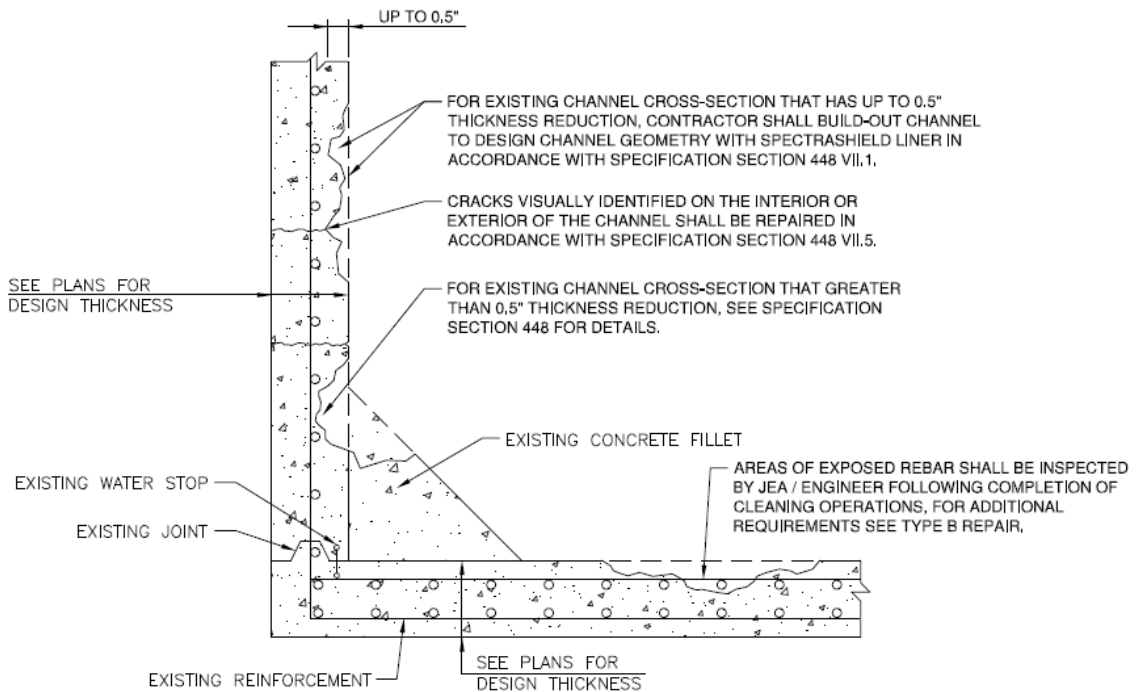

### NOTES:

1. MAINTAIN WORK AREA VENTILATION THROUGHOUT THE DURATION OF THE CHANNEL REHABILITATION WORK. ALL WORK & INSPECTIONS SHALL BE COMPLETED BY PERSONNEL WITH CONFINED SPACE CERTIFICATIONS.
2. ALL VISIBLE CRACKS AND ACTIVE SEEPS SHALL BE REPAIRED AND SEALED PRIOR TO FINISHING THE SURFACE PREPARATION AND SUBSEQUENT SPOT REPAIR PER DETAILS
3. THE FINAL STEP IN SURFACE PREPARATION SHALL BE A WATER FLUSHING AND SURFACE DRYING OF THE ENTIRE AREA TO BE REHABILITATED INCLUDING THE AREA OF THE CRACK AND SEEP REPAIRS, AND REINFORCEMENT REPAIR PER SPECIFICATIONS ANY CONCRETE REPAIR AREAS SHALL HAVE A 28-DAY CURE TIME BEFORE FINAL COATING CAN BE APPLIED.
4. THE PREPARED SURFACE SHALL BE INSPECTED AND ACCEPTED IN ACCORDANCE WITH SPECIFICATION SECTION I.5. PRIOR TO INSTALLATION OF THE COATING SYSTEM.
5. OVERHEAD AND VERTICAL REPAIRS SHALL EMPLOY A CEMENTITIOUS MORTAR SUITABLE FOR THE REPAIR.

### TYPE A REPAIR

#### V.2. TYPE B REPAIR: PARTIAL DEPTH REPAIR - 0.5" TO 3.0"

Repairs shall be defined as removal of unsound concrete to a depth of 3.0" or the top/face of the reinforcing steel, whichever is shallower. A cementitious repair shall be installed as described on the Drawings.

# JEA Water and Wastewater Standards 448 Existing Concrete Preparation and Repair

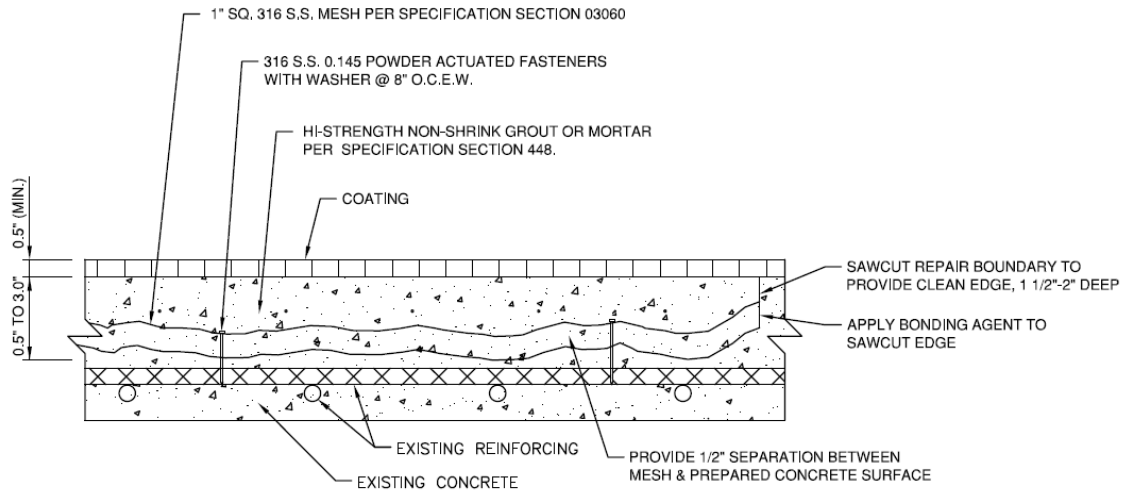

TYPE B REPAIR

### V.3. TYPE C REPAIR: FULL DEPTH REPAIR GREATER THAN 3.0" WITHOUT REINFORCEMENT REHABILITATION

For repairs without reinforcement rehabilitation, where unsound concrete extends beyond the reinforcing steel, the Contractor shall continue to remove all further concrete within the repair area until sound material is encountered. All existing reinforcing steel shall be cleaned back to near white metal to remove any scale or corrosion prior to being assessed for deterioration. Where the steel is sound, a cementitious repair shall be applied in accordance with the Drawings.

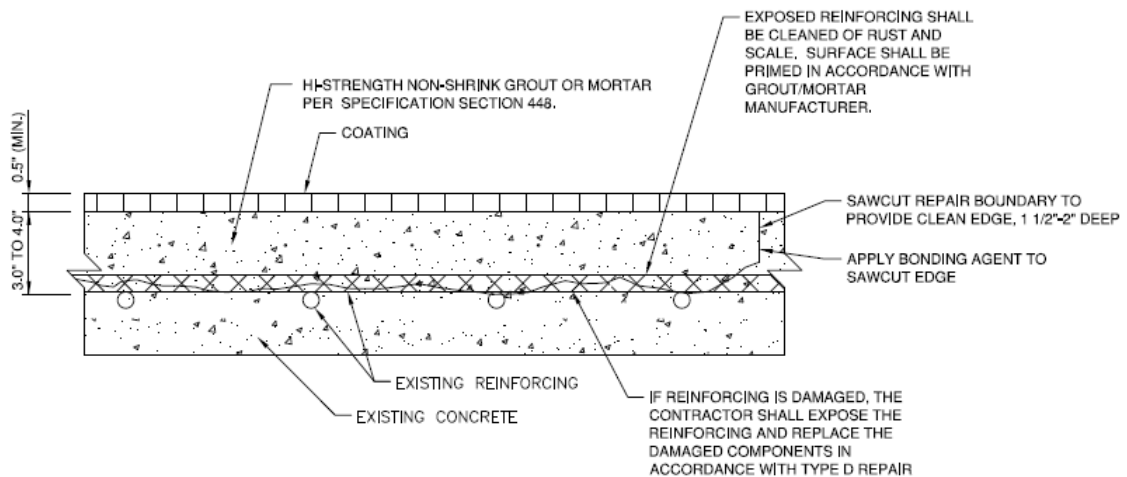

TYPE C REPAIR

### V.4. TYPE D REPAIR: FULL DEPTH REPAIR - GREATER THAN 3.0" WITH REINFORCEMENT REHABILITATION

For repairs with reinforcement rehabilitation, where unsound concrete extends beyond the reinforcing steel, the Contractor shall continue to remove all further concrete within the repair area until sound material is

# JEA Water and Wastewater Standards 448 Existing Concrete Preparation and Repair

encountered. All existing reinforcing steel shall be cleaned back to near white metal to remove any scale or corrosion prior to being assessed for deterioration. Reinforcing steel shall be replaced in accordance with Section I.8., and a cementitious repair shall be applied in accordance with the Drawings.

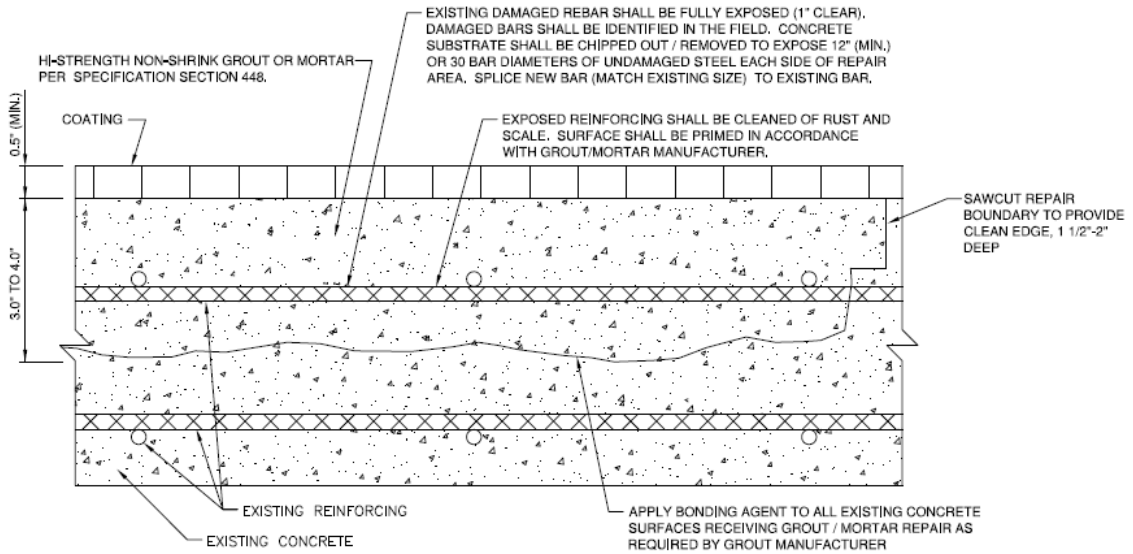

TYPE D REPAIR

## V.5. TYPE E REPAIRS: CRACK REPAIRS

Contractor shall identify all existing cracks within the top slabs, walkways, etc. of the rehabilitation areas defined in the Contract Drawings. The cracked areas shall be repaired in accordance with the Drawings.

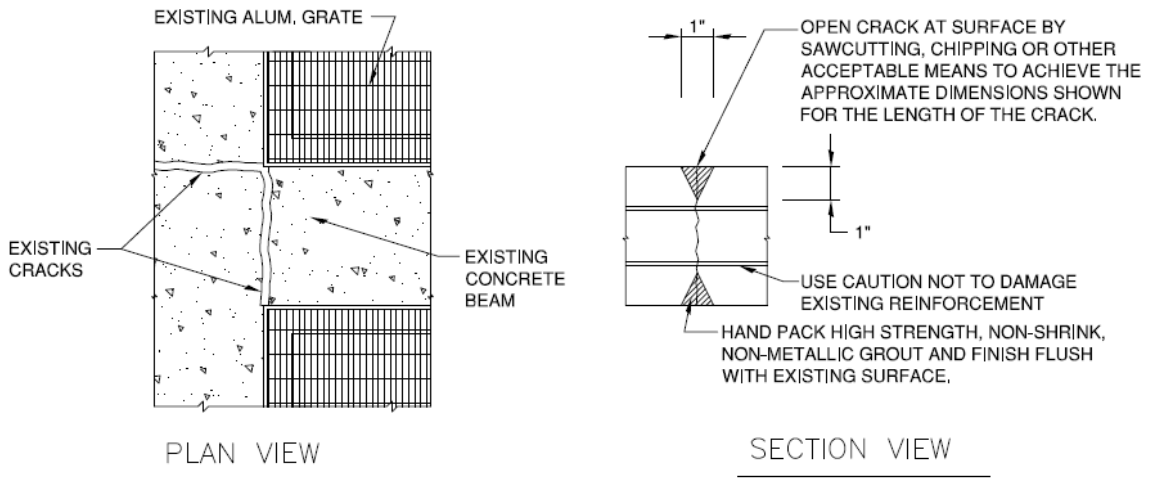

TYPE E REPAIR

## V.6. REINFORCING STEEL

# *JEA Water and Wastewater Standards*

## *448 Existing Concrete Preparation and Repair*

- V.6.1. The Contractor shall supply and place additional reinforcing steel as shown when the existing reinforcing steel has a section loss of 25% or greater.
- V.6.2. The reinforcing steel shall be of the same type and size as the existing, and spliced with a minimum lap length of 30 bar diameters, but not less than 12".
- V.6.3. Exposed reinforcing steel shall be blasted clean and maintained to a near white condition. Exposed reinforcing steel shall be primed in accordance with cementitious repair product manufacturer requirements.

### **VI. MATERIAL & BY-PRODUCTS**

All resulting material and by-products from demolition operations shall be collected, loaded, hauled, and disposed of by the Contractor as an approved waste disposal facility.

### **VII. SURFACE PREPARATION**

Immediately prior to placing the repair mortar or concrete, the Contractor shall thoroughly clean the existing concrete surfaces and formed repair areas, and apply a low resistivity bonding agent or cement slurry as recommended by the repair mortar manufacturer or as directed by the Engineer.

#### **VII.1. MORTAR/GROUT PLACEMENT AND FINISHING**

- VII.1.1. The concrete repair mortar/grout shall be handled, stored, mixed and applied in accordance with the manufacturer's instruction.
- VII.1.2. Immediately prior to placing the repair mortar, the Contractor shall thoroughly clean the existing concrete surfaces and formed repair areas, and apply bonding agent or cement slurry as recommended by the repair mortar manufacturer or as directed by the Engineer.
- VII.1.3. The Contractor shall place the repair mortar such that the existing profile and cross section are restored to their original dimensions.
- VII.1.4. If the existing or repair concrete surface is damaged in any way by construction operations, or if the concrete repair shows signs of distress or scaling prior to final acceptance, it shall be repaired or replaced by the Contractor at his own expense. All repair areas shall be trowel finished to a level similar to the adjacent existing concrete surfaces.

### **VIII. CURING**

Curing shall be in accordance with the manufacturer's instructions.

### **IX. QUALITY CONTROL**

Concrete repair mortar that is not stored, handled, prepared, placed, or cured in accordance with the manufacturer's instructions will be rejected by the Engineer and his/her decision shall be considered final. The Engineer reserves the right to require immediate removal of any concrete from rejected batches that may have already been placed in the structure. Quality assurance testing will be carried out by the Contractor's testing agency and all associated costs will be paid for by the Contractor. Refer to Chapter XVI - Section 437 for testing requirements.

## **470 - EMERGENCY PUMP ENGINES SECTION**

### **I. GENERAL REQUIREMENTS**

#### **I.1. SCOPE OF WORK**

The Contractor shall furnish, install and test a complete, self-contained, automatic standby emergency pump engine system as specified herein. The self-contained emergency pump engine system shall consist of a pump and engine unit, which upon interruption of normal power from MCC or high float level, will provide the required pumping capacity for the station. Diesel engine driven pump sets shall be of the latest commercial type and design with all necessary controls. Contractor shall furnish and install fuel tank, enclosure, engine foundation and fuel tank foundation and all accessories necessary for a complete and operable installation. The enclosure shall be weatherproof, constructed with 5000 marine- grade aluminum. All materials shall be new unless specifically called for otherwise. Under this purchase order number or contract number, JEA and the contractor shall be entitled to the special rates and purchase price of equipment and services. The contractor (not JEA) shall pay all cost associated with the installation of the emergency backup pump engine system.

#### **I.2. SHOP DRAWING SUBMITTALS AND ADDITIONAL SUBMITTALS**

The Contractor shall be required to submit a complete shop drawing submittal, signed and sealed by a Florida Registered Professional Engineer.

I.2.1. Five hard copies, plus the number of copies the Contractor wishes returned as well as three electronic copies, shall be submitted to the Engineer for approval.

I.2.2. List of five or more operating installations using major components of the same or similar type equipment furnished for this project.

I.2.3. Name and address in Jacksonville of permanent parts supply from which parts may be obtained in sufficient quantity on a 24 hour basis.

I.2.4. Shop drawings of the pump engine set, complete power and control wiring diagrams, foundation requirements, auxiliary equipment required including tanks, switches, controls, weatherproof enclosure, breaker, wiring and accessories shall be submitted.

I.2.5. Manufacturer's product data describing unit, auxiliary equipment required, including switches, engine, and pump. Include the following:

- Specifications for fuel
- Make of engine
- Number of cylinders
- Compression ratio
- Bore, inches
- Stroke, inches
- Piston displacement, cubic inches
- Piston speed at rated RPM, feet per minute
- Make and type of pump

# *JEA Water and Wastewater Standards*

## *470 Emergency Pump Engines*

- Pump rating

I.2.6. Two complete sets of operating and maintenance manuals shall be supplied for the pump/engine set and for auxiliary equipment. And one digital copy to be supplied to Facilities O&M Department

I.2.7. Manufacturer's warranty. (Digital Copy to Facilities O&M)

### **I.3. RATING**

Pump Engine set shall be capable of producing rated output for continuous duty at rated engine pump RPM when equipped with necessary operating accessories such as air cleaners, lubricating oil pump, fuel transfer pump, radiator fan, and jacket water pump. Responsibility for sizing pump engine shall lie with the pump engine supplier and engineer.

### **I.4. QUALITY ASSURANCE**

I.4.1. Unit shall be the product of a firm regularly engaged in the manufacture of diesel engines and pumps, and a standard model in regular production at the manufacturer's place of business. Both engine and pumps shall be warranted by the same manufacturer to establish single source responsibility.

I.4.2. Only current units which can be properly maintained and serviced without the necessity of JEA carrying extensive parts stock, or being subject to long periods of interrupted service due to unavailable parts will be considered. Pump-Engine supplier shall maintain a local parts and service facility. Service facility shall have no less than 80 percent of all engine replacement parts in its stock at all times.

### **I.5. WARRANTY AND SERVICE CONTRACT**

#### **I.5.1. PUMP – ENGINE MANUFACTURER WARRANTY**

Equipment furnished under this section shall be guaranteed against defective parts and workmanship under terms of the manufacturer's and dealer's standard warranty for 5 years from date of acceptance of the system and shall include labor, travel time for necessary repairs and the supply of a complementary pump/engine set at the job site for duration of the repairs. Running hours shall not be a limiting factor for the system warranty.

#### **I.5.2. CONTRACTOR WARRANTY**

The Contractor shall supply to JEA a two (2) year unconditional warranty after substantial project completion or project acceptance or any other design portion thereof. The warranty shall include materials and installation and shall constitute complete replacement and delivery to the site of materials and installation of same to replace defective materials or defective workmanship with new materials/workmanship conforming to the specifications.

#### **I.5.3. FACTORY REPRESENTATIVE**

The manufacturer shall provide the services of a factory-trained service representative to verify the correctness of the Contractor completed installation; to check all electronic circuitry and mechanical components to assure their proper function; to make all necessary measurements in and around the engine and pump. A minimum of 2 days startup services shall be provided. The manufacturer shall provide through the Contractor to JEA a written certification that the installation

# *JEA Water and Wastewater Standards*

## *470 Emergency Pump Engines*

is complete, correct and properly calibrated; by written notation for the pump engine certification and the Contractor shall endorse its accuracy.

### **I.6. PERMITTING OF ABOVE GROUND FUEL STORAGE TANK (LARGER THAN 550 GALLONS)**

Prior to construction of an aboveground fuel storage tank, the contractor shall obtain a copy of the approved construction permit by local regulatory agencies for the installation of the fuel tank. The contractor shall coordinate with David Norse (904) 665-5501 of JEA to assist with this effort and DEP notifications in accordance with state of Florida Guidelines.

## **II. DIESEL ENGINE**

### **II.1. ENGINE REQUIREMENTS**

- II.1.1. Diesel engine shall be vertical or "V" multi-cylinder, full diesel, mechanical injection, heavy-duty type with non-Electronic Control Module (ECM), arranged for direct connection to a pump engine, and shall be the product of a manufacturer regularly engaged in the building of full diesel engines. Engine shall be a current model which has been in regular production for at least three years. Engine shall develop sufficient brake horsepower, net rated RPM, corrected to sea level barometric pressure (29.92 in. HG) and 110 degrees F, to operate pump continuously at its rated output with all losses included without undue heating, vibration or wear. Diesel engine shall be water-cooled four cycle compression ignition diesel. The engine exhaust manifold shall have an expanded metal guard spread sufficiently away from hot parts. Engine shall meet specifications when operating on off road ultra-low sulfur diesel.
- II.1.2. Diesel Pump Engine and Vendor on approved list as per AS-605 in Water & Waste Water standards.
- II.1.3. Engine shall be equipped with a pressure lubrication system supplying oil to all surfaces requiring lubrication. Circulation shall be by a positive displacement pump. Lubrication system shall include a full flow strainer, oil filter, and an oil cooler of sufficient capacity to properly cool all lubrication oil circulated.
- II.1.4. Engine shall have an individual mechanical injection pump and injection valve for each cylinder. Injection pumps and injection valves shall not require adjustment in service. Fuel injection pumps shall be positive action, constant-stroke pumps, actuated by a cam-driven by gears from the engine crankshaft. All injection pumps and valves shall be serviced by Engine Manufacturer certified personnel.
- II.1.5. Fuel lines between injection pump and valves shall be heavy 316 SS seamless tubing; and, to eliminate irregularity of fuel injections, shall be of the same length for all cylinders.
- II.1.6. Fuel system shall be equipped with replaceable fuel filter elements, which may be easily removed without breaking any fuel line connections or disturbing the fuel pumps or another part of the engine. Provide easily serviceable and replaceable Bypass RACOR fuel/water separator/filter ahead of other fuel filters.
- II.1.7. All fuel filters shall be conveniently located in one accessible housing, ahead of injection pumps so that fuel will have been thoroughly filtered before it reaches the pumps. No screens or filters requiring cleaning or replacement shall be used in injection pump or injection valve assemblies.



## *JEA Water and Wastewater Standards*

### *470 Emergency Pump Engines*

- II.1.8. Engine shall be equipped with a built-in gear-type engine-driven fuel transfer pump, capable of lifting fuel against a head of twelve feet, for supplying fuel through filters to injection pump at constant pressure.
- II.1.9. Engine shall be provided with suitable safety controls to automatically stop the unit when low oil pressure, water temperature or engine speed exceeds safe limits. Pilot lights shall be provided to visually indicate the cause of engine shut down. Pilot lights shall operate off battery circuit and shall be on pump-engine control panel. Provide contacts for remote engine failure annunciation.
- II.1.10. Engine shall be equipped with a bronze glow(dipped) coated aluminum radiator and blower fan of sufficient capacity for cooling engine when diesel set is delivering full rated speed an ambient temperature of 125 degrees F. Air flow restriction from radiator shall not exceed 0.5 inches H2O. Engine shall have a thermostat integral with jacket water circuit to maintain water at proper operating temperature. The radiator tank can be plastic. Engine shall have a belt driven centrifugal type water pump for circulating water through cooling system.
- II.1.11. All fined aluminum coils heat transfer system to include fuel, oil and any others shall be Bronz Glow Dipped (Husky Coat).
- II.1.12. Provide a critical-grade type exhaust silencer, manufactured of 316 stainless steel as specified in this specification.
- II.1.13. Engine shall be provided with an antifreeze solution of 50 percent ethylene glycol, and suitable unit mounted, thermal circulation type water heater incorporating a thermostatic switch to maintain engine jacket water at 90 degrees F. in an ambient temperature of 30 degrees F. Heater shall be 1000 watts minimum, single phase, 60 Hertz, and applicable voltage. Jacket water heater hoses shall be reinforced rubber heater hose type or better with ball valves to isolate hose in the event that the hoses or JWH needs replacing.
- II.1.14. Furnish a set of spare parts and tools regularly supplied with engine. Include all tools of a special nature required to properly service engine.
- II.1.15. Provide one or more engine-mounted dry type air cleaners of sufficient capacity to protect working parts of the engine from dust and grit
- II.1.16. Engine shall be equipped with an oil/ vapor recovery container or box that meets EPA regulations. The intent of the recovery system is so the blow by waste will not escape into the atmosphere or soak the radiator coils, as well as be a possible housekeeping issue around the engine-generator.
- II.1.17. All engine exhaust emissions shall meet EPA requirements for standby power generation.
- II.1.18. Engine starting system shall include an electric motor start system of not less than 24 volts, including DC starting motor, required voltage battery pack and rack, cables, and battery charger.
- II.1.19. For engine-generator, sets rated 750 kW and above, a redundant electric starting motor shall be provided.
- II.1.20. The batteries shall be of the lead acid type. The batteries shall be sized to provide the specified number of starts, cranking time at firing speed (five 10-second cranks) at any ambient between minimum (7 °F) and maximum (105 °F) design ambient temperatures, with final discharge voltage,

# *JEA Water and Wastewater Standards*

## *470 Emergency Pump Engines*

exceeding minimum control power supply voltage requirements. The batteries shall have a capacity of 135 AH minimum. Batteries shall be complete with cables and rack. Battery shall be rated in accordance with requirements of engine manufacturer. Batteries shall be located for easy removal and servicing.

### **II.2. BATTERY CHARGER**

- II.2.1. Current limiting battery charger to automatically charge batteries.
- II.2.2. Charger shall be dual charge rate with automatic switching to boost rate when required.
- II.2.3. Charger shall be mounted at rear of engine-generator set inside the enclosure.
- II.2.4. Control wire connection between starting and safety circuits shall be pre-connected before arriving at job site.
- II.2.5. The service powered battery charger shall float charge the battery pack and shall be solid-state, full wave bridge rectified type, using silicon controlled rectifiers for power control. The battery charger shall be suitable for the required voltage, and current, battery pack type, shall have a DC output circuit breaker, floating voltage equalization, equalizing timer, a ground detection system, a voltage relay to activate low battery voltage alarms at the engine-generator control panel, and battery charger failure which shall alarm at the engine-generator control panel. Charger shall be 120v single phase

### **III. PUMP**

- III.1.1. Pump shall be designed so all components are accessible with a minimum amount of labor. Both engine and pump shall be warranted and serviced by same manufacturer.
- III.1.2. Close-coupled centrifugal pump with vacuum priming compressor mounted to a diesel engine.
- III.1.3. Continuously operated air injector priming device requiring no periodic adjustment or control.
- III.1.4. Centrifugal pump shall be capable of handling 3" diameter non-compressible solids.
- III.1.5. Centrifugal pump shall be capable of fully self-priming on its own with a 25' static suction lift without the need of a foot valve or add-on priming device.
- III.1.6. Liquid-filled vacuum gauge for system diagnostics shall be viewable from outside enclosure.
- III.1.7. GR – Ready Prime Series type pump or equal.

### **IV. ENGINE STARTING AND CONTROL PANEL**

- IV.1.1. Furnish and install an automatic starting mechanically controlled engine panel in the pump- engine enclosure (Section V.) Starting section shall automatically start engine upon high level sensor through starting contacts in control panel. Unit shall serve to operate as follows: High level sensor contact initiates starting cycle of diesel engine. Lack of oil pressure or over- temperature of cooling system will cause second relay in cranking panel to be energized, causing starting cycle to be terminated immediately. Should engine fail to start for any reason, a time- delay relay in cranking

# *JEA Water and Wastewater Standards*

## *470 Emergency Pump Engines*

panel limits its cranking period to 30 seconds. A push-button switch mounted on cranking panel shall allow engine to be further cranked at the operator's discretion. Resumption of low level shall open engine contacts in control panel and shall cause engine to shut down after 5 minute delay.

- IV.1.2. Pump-engine controls will include an auto-start feature controlled by one or more float balls or submersible transducer. It shall be a mechanical non-mercury type float switch housed in a hermetically sealed polypropylene enclosure designed to extend into a wet well. The transducers polyurethane jacket shielded cable shall be of suitable length for proper installation into a wet well without splicing. The level control system shall continuously monitor the wet well level. Upon operator selection of automatic operation, the level controller shall start the pump- engine unit when the liquid level in the wet well rises to the pump start level. When the liquid is lowered to the pump stop level the level controller shall stop this pump – engine.

### **IV.2. ENGINE CONTROLS**

#### **IV.2.1. MECHANICALLY CONTROLLED ENGINE**

Mechanically controlled engine control panel shall provide the following functions:

- Battery DC volts
- Coolant temperature
- Lube oil pressure
- Pump-Engine set operating hours
- With exception to mechanical control is fuel solenoid, starter and shutdown sensors.

#### **IV.2.2. DIGITAL CONTROLLER**

The engine shall be started, stopped, and controlled by a digital controller. The controller shall be weatherproof enclosed, and contain an external weatherproof keypad accessible without the need to remove or open any protective cover or enclosure. It shall be designed to start/stop the engine at a signal supplied by high and low level floats or a 4-20 mA transducer. The controller shall provide the following functions without modification, factory recalibration, or change of chips or boards, by simply accessing the keypad.

- IV.2.2.1. The keypad shall be a capacitive touch sensing system. No mechanical switches will be acceptable. The keypad shall operate in extreme temperatures, with gloves, through ice, snow, mud, grease, etc. and maintain complete weather-tight sealing of the controller.
- IV.2.2.2. In automatic mode, the unit shall conserve energy and go to "sleep".
- IV.2.2.3. The controller shall function interchangeably from float switches, pressure switch, or transducer, as well as manual start/stop by selection at the keypad. No other equipment or hardware changes are required.
- IV.2.2.4. The controller with integrated auto-throttle shall be capable of varying the engine speed to maintain a constant level or pressure in a process without a change to the controller other than via the keypad.

# *JEA Water and Wastewater Standards*

## *470 Emergency Pump Engines*

IV.2.2.5. The start function can be programmed to provide three separate functions each day for seven days (i.e. a start, warm up, exercise cycle on two separate days at different times and for a varying length of time all via the keypad).

### **IV.2.3. MANUAL-AUTOMATIC BUTTON**

IV.2.3.1. In Manual Mode, manual "Start" button starts engine and runs until "Stop" button is depressed or an emergency shutdown occurs.

IV.2.3.2. In Automatic Mode, start/stop sequencing is initiated by either two normally-open narrow angler float switches, pressure switch, level transducer, or a signal from a digital input.

IV.2.3.3. The controller shall integrate the engine safety shut-off for low and high oil temperature along with coolant, and provide over-speed protection.

IV.2.3.4. The controller shall include standard, field-adjustable parameters for engine cycle crank timer, shutdown time delay, warm-up time delay, and cool-down time delay.

IV.2.3.5. The controller shall have only one circuit board with eight built-in relays.

IV.2.3.6. Three of the relays shall be programmable to output desired parameter on display and to be used as dry-contacts for communication with JEA SCADA system, all via the keypad without changing relays, chips, printed circuits, or any hardware or software.

IV.2.3.7. Standard components shall consist of (24) digital inputs, (7) analog inputs, (1) magnetic pick-up input, (8) 20-amp form "C" relays, (1) RS232 port, (1) RS485 port, (1) RS232/RS485 port, (1) J1939 port, and (1) Full graphic LCD display with backlight.

IV.2.3.8. The industrially-hardened Controller shall withstand 10ppm H<sub>2</sub>S, Vibration of 3 g, 3 axis, frequency swept 10-1000 Hz, in an operating temperature range of 4° to 176°F (-20° to 80°C) and an operating humidity range of 0-95% Non- Condensing.

IV.2.3.9. Controller shall be capable be capable of communicating all status and control via ONE of the following protocols Modbus, Profibus or Profinet.

IV.2.3.10. Controller shall have programmable parameters to prevent surges in the system such as ramp time, high discharge pressure warning and shutdown.

IV.2.3.11. Over-speed protection and indicator

IV.2.3.12. Low lube oil pressure protection and indicator

IV.2.3.13. High coolant temperature protection and indicator

IV.2.3.14. Over-crank protection and indicator

IV.2.3.15. Low coolant level protection

IV.2.3.16. Engine Control Switch (Three-Position: Stop – Manual – Auto)

# *JEA Water and Wastewater Standards*

## *470 Emergency Pump Engines*

IV.2.3.17. Indicator/Display, Test Switch

IV.2.3.18. Control device shall be non-alternator driven speed control reframe. Control device shall be read off the magnetic pick-up.

IV.2.3.19. Unit shall be capable of interfacing with JEA SCADA equipment.

### **IV.3. WEATHERPROOF ENCLOSURE, NON-WALK-IN TYPE**

IV.3.1. The complete pump-engine set shall be enclosed in a modular, non-walk-in type, marine grade aluminum weatherproof enclosure, constructed with 5000 marine grade aluminum. The enclosure shall be constructed of removable side panels and end panels. All fasteners and hardware used in construction of the enclosure shall be type 316 stainless steel. The unit shall have hinged side doors each side and hinged doors at control end, equipped with key locks for ease of engine maintenance, hold open devices and a three point latch system. Doors shall be pad-lockable and a minimum of 36 inches. There shall be a stainless steel expanded metal grating or a punched louvered radiator core guard installed - flush with the enclosure panels in front for the radiator grill, and fixed, punched louvered air intake ports on the enclosure sides and rear for proper air circulation within the housing. Provide lifting eyes and spreader bar reinforcement for crane unloading. Provide ¼ inch thick "non-skid" deck underneath housing. The enclosure shall be constructed as a sound-attenuated style with a maximum dba rating of 85 dba at 15 feet.

IV.3.2. Battery charger shall be mounted at rear of engine set. Control shall incorporate equipment as previously specified. Control wire connection between starting and safety circuits shall be pre-connected before arriving at job site. Provisions shall be made for mounting batteries and rack inside the enclosure. The engine control panel, distribution (lights, battery charger jacket water heater, etc.) Breaker panel, batteries and accessories shall be enclosed in the enclosure.

IV.3.3. All engine oil and coolant drains shall be piped to outside of enclosure with shutoff valves and shall have threaded 316 stainless steel with anti-sieze. The threaded drain lines shall be labeled on the outside of the enclosure with an aluminum label with aluminum or stainless rivets.

IV.3.4. Secondary enclosure color allowed, if requested by special organization or HOA, is pad-mount green, steel-master 9500 30% silicone alkyd enamel ultra deep/clear tint base supplied by Sherwin-Williams.

IV.3.5. A minimum of two industrial led fixtures from Columbia Lighting model lxem4- 40ml-rfa-edu or equivalent approved by JEA, spring wound timer light switch, prewired distribution circuit, power panel, and duplex receptacles shall be conveniently provided in the enclosure. The light switch and receptacles shall be provided near pump control panel. (for use on large pump engines. Please note fixture JEA standard)

IV.3.6. Structural wind rating requirement reference 2010 FBCB and asce-7-10. JEA requires wind design of 150 miles per hour.

IV.3.7. Enclosure shall be Phoenix Products, Advanced Manufacturing & Power Systems Inc. Or fidelity Manufacturing, Thompson Pump, Holland Pump and Godwin Pump.

### **IV.4. EXHAUST AND MUFFLER**

# *JEA Water and Wastewater Standards*

## *470 Emergency Pump Engines*

- IV.4.1. Each engine-generator unit shall be furnished with complete exhaust system including a stainless steel exhaust silencer, all-stainless steel piping, all-stainless expansion joints and accessories as required for a complete operating system.
- IV.4.2. The exhaust silencer shall be chamber type, of all-welded type 316 stainless steel construction with all 316 stainless steel hardware and fasteners. The silencer shall be of the side inlet type secured in position at no less than 4 points.
- IV.4.3. The silencer shall be supported by a welded 316 stainless angle iron cradle; silencer shall be bolted or strapped to cradle and then bolted to the exterior roof; support members mounted inside the roof of the enclosure for a horizontal mounting on top of the enclosure.
- IV.4.4. The silencer shall be sized so that the backpressure at rated capacity of the engine does not exceed one-half the supplier's maximum allowable backpressure. The silencer shall be suitable for critical type silencing and shall be a Maxim "Model M51".
- IV.4.5. All exhaust piping shall be type 304L, schedule 10s stainless steel, and the exhaust shall discharge horizontally at the silencer outlet with 45 degree bevel cut with a stainless expanded metal bird screen.
- IV.4.6. The intake of the silencer shall connect to the flexible exhaust connection by stainless steel pipe. Size as required by engine manufacturer. A flexible stainless steel exhaust adapter, 18 inch minimum length, shall be furnished for mounting between the engine and silencer. The flexible exhaust connection as specified shall mount directly on exhaust manifold and shall be mounted so that no weight is exerted on the manifold at any time.
- IV.4.7. Each engine-generator unit shall be furnished with complete exhaust system including a stainless steel exhaust silencer, all-stainless steel piping, all-stainless expansion joints and accessories as required for a complete operating system.

## **V. FUEL STORAGE TANK**

### **V.1. DOUBLE WALL SUB-BASE TYPE FUEL STORAGE TANK**

The tank shall be UL listed, vented, and shall normally be used to store the specific petroleum product at atmospheric pressure. The sub-base fuel storage tank shall have a minimum capacity to provide 72 hours uninterrupted operation of the pump-engine at 100 percent capacity. The sub-base tank shall be of welded steel construction throughout and shall be constructed to permit access to the electrical stub up area. The tank shall have an over fill containment box that will hold 5 gallons minimum and have a normally closed, hand operated valve to drain over spill content back into tank. The coating of the tank shall meet the coating specifications in section VII.11. The tank shall be electrically grounded and secured to slab with 4-6 stainless steel anchor bolts w/ stainless steel washers and fasteners.

### **V.2. ABOVE GROUND FUEL STORAGE TANK**

An aboveground stand-alone fuel storage tank shall be installed when applicable per the JEA representative. The insulated secondary containment aboveground storage tank system for flammable and combustible liquids shall be vehicle impact protected and projectile resistant over 300 GL. Storage capacity shall be 72 hours rated at maximum fuel consumption. Tank shall be a steel tank housed in a double containment concrete vault/tank. The tank shall be manufactured by "ConVault, Inc.", Phoenix Products "Envirovault", General Industries, Modern Welding or Godwin Pumps.

# *JEA Water and Wastewater Standards*

## *470 Emergency Pump Engines*

The tank shall be tested to and listed (and carry UL/ULC labels) for the following:

- UL - 142, Aboveground Tanks For Flammable and Combustible Liquids
- UL - 2085, Two Hour Furnace Fire Test and Two Hour Simulated Pool Fire Test For Insulated Tank
- UL - 2085, Insulated and Protected Secondary Containment Aboveground Tanks For Flammable And Combustible Liquid.
- UL - 2085 and UFC Section (79-7) Appendix #A-II-F-1, Ballistic and Vehicle Impact Test For Protected Tank
- UL - 2085 Non-Metallic Secondary Containment and Venting by Form of Construction

### **V.3. REQUIREMENTS**

#### **V.3.1. STEEL TANK CONSTRUCTION**

Steel tank shall be made of 3/16 inch thick steel. The steel tank shall hold the liquid fuel. The tank shall be made in accordance with UL Standard 142 and ULC Standard S601 covering all aspects of tank fabrication including material specification, fabrication, welding and testing. The steel tank's exterior shall be coated with primer paint for protection against corrosion. All tanks shall have 2" ground clearance to allow visual inspections as required by FDEP. At the fabrication shop, the tank shall undergo a 24-hour pressure test at 5 psig.

#### **V.3.2. SECONDARY CONTAINMENTS**

V.3.2.1. The steel tank shall be wrapped with a minimum of ¼ inch thick styrofoam (foam) insulation and an impervious barrier of 30-MIL high density polyethylene membrane (poly). The 30- MIL poly shall provide containment for a fuel leak through the steel tank. A leak detector pipe terminating in the secondary containment shall provide positive-proof that the tank is not leaking.

V.3.2.2. The 30-MIL poly, shall shield and protect the steel tank exterior from coming in direct contact with the concrete and thus minimize the potential of tank external corrosion.

#### **V.3.3. CONCRETE VAULT**

The tank and secondary containment shall then be encased in a 6 inch thick reinforced concrete vault. The 6 inches of concrete shall be poured on all sides, bottom and top of the tank in one step and be monolithic. This process assures that there are no joints and no heat sinks in the concrete to carry heat from a fire into the primary containment.

#### **V.3.4. COATING AND FINISHING**

The concrete exterior of the tank shall be vacuum coated using a two- part water based epoxy paint to protect the tank from inclement weather conditions. The entire pipe fittings and nipples on the tank shall be coated with Fast Clad DTM Urethane Mastic paint to protect them from corrosion, there shall be an intermediate and finish coat.

#### **V.3.5. OVERFILL PROTECTION**

The tank shall be provided with the following methods to protect against overfill: (a) direct reading level gauge at the tank which is visible from fill pipe location, Greenleaf EFG 8000-I solar gauge

# *JEA Water and Wastewater Standards*

## *470 Emergency Pump Engines*

with AC back up mounted on exterior of enclosure and 4-20mA.1 data converter mounted in engine control panel; (b) valve located within fill pipe access to close automatically at a specified fill level.

### **V.3.6. VENTING**

The tank system shall be furnished with a 2-inch normal vent and an emergency pressure relief system. The standard emergency relief system furnished with the tank shall open if the tank pressure exceeds ½ psi. The tank system shall conform to code requirements and UL/ULC Standards for venting. All vents and fittings utilized on the fuel tank shall be constructed of stainless steel.

### **V.3.7. SUPPORT LEGS**

Vault shall have support legs that provide visual inspection capability.

### **V.3.8. THERMAL AND CORROSION PROTECTION**

The tank construction shall provide thermal insulation to protect against temperature extremes and corrosion by separating the steel tank from the concrete section VII.4.2. No part of the steel tank shall come in direct contact with concrete or any other corrosive material.

### **V.3.9. SPILL CONTAINMENT**

The tank system shall include a 5 gallon minimum, 316 stainless steel spill containment surrounding the fill pipe. The spill container shall be equipped with a normally closed, hand-operated valve that can be actuated to drain the spilled fuel liquids into the steel tank. Fill neck shall be 2" unobstructed tube with aluminum Cam Lock Cap

### **V.3.10. BULLET RESISTANCE**

The tank shall withstand bullet resistance tests for all tanks over 300 GL in compliance with UFC Section (79-7), Appendix #A-II-F-1-

### **V.3.11. UPLIFT RESTRAINTS**

The tank shall be supplied with flood resistant tie-down brackets/hurricane hold-down restraints or bolted down to foundation.

### **V.3.12. FIRE EXTINGUISHER AND CLEAN-UP KIT**

Portable fire extinguishers must be provided for the suppression of fires in accordance with NFPA 10 and UFC for high hazard area. Fire extinguisher and clean-up kit shall be sized and provided by the tank manufacturer. Fire extinguisher shall be of the ABC type and mounted on the interior of the enclosure at the control panel with 316 stainless steel bracket and fasteners. Clean-up kit shall be similarly mounted inside the pump-engine enclosure.

### **V.3.13. FUEL PIPING**

V.3.13.1. There shall be an anti-siphon valve above the manual stainless steel fire-safe shutoff valve on all standalone fuel tanks 551 gallons and above as required per FDEP. All anti-siphon valves must be adjustable and sized for exact rise and run of fuel piping per the site conditions.

V.3.13.2. The diesel fuel piping shall be standard weight (Schedule 40) 316 stainless steel with socket welded fittings per ASTM standards. At the option of the supplier, use Schedule



# ***JEA Water and Wastewater Standards***

## ***470 Emergency Pump Engines***

40 316 stainless steel with welded fittings. All piping shall be welded and done by a ASME certified pipe welder. Where flange fittings with petroleum rated gasket (threaded union optional) is required, within two feet of Antisiphon Valve, use Hercules Chemical Co. "Megaloc or Real-tuff" all- purpose pipe dope on all stainless steel threaded connections. Vendor / Contractor must warranty all piping connections to be free of any leaks, drips or weeping for one year. All fuel piping shall be above ground. All piping mounted at ground level shall be strapped to 316 SS Unistrut fasted to pavement. All piping in walkways shall have diamond deck cover or stairs to prevent tripping hazards in walkways.

- V.3.13.3. Above ground fuel storage tanks that have fill box openings over 48 inches above grade shall have aluminum or stainless steel stairs and platform at the fuel port. Larger base tanks over 36" in height or enclosures that have a walk-in type enclosure shall have access stairs or ladders that are located on two sides of the enclosure/base tank made of aluminum. The stairs/ platform shall be secured to concrete slab using 316 stainless anchor bolts and washers. Units between 12 and 36 inches in height shall have a ships ladder and hand rail on each side under all enclosure doors.
- V.3.13.4. Supplier shall provide 90% of fuel for 72 hour operation, at rated tank capacity for any and all turnkey installations by supplier. Fuel shall be off road ultra-low sulfur diesel, NO BIODIESEL PERMITTED. Fuel delivery shall take place prior to load bank test. Supplier shall treat fuel with Hydro Clean made by Gulf Select.
- V.3.13.5. JEA Maintenance, City of Jacksonville and Environmental Departments including the JEA Project Manager, shall be notified by supplier between 45 days and 30 days, and again between 72 hours and 48 hours in advance of above ground fuel storage tank shipments greater than 550 gallons. DEP's Chapter 62-762 for Aboveground Storage Tank Systems shall be followed.

### **V.3.14. INSTALLATION**

- V.3.14.1. Tank shall be installed as per manufacturer's requirements and as per the drawings. Tank shall be installed by qualified personnel who have been approved by the manufacturer and who have knowledge of, and possess the skills and equipment necessary, to install this type of aboveground storage tank properly and safely. Do not handle or move the tank unless it is empty. Under no circumstances should a tank containing petroleum product be moved. Do not drop or drag the tank. After install of tank a two part epoxy touch up paint shall be applied to the exposed metal. All mounting hardware shall be 316 stainless steel.
- V.3.14.2. Installation, operation and maintenance of the tank shall be carried out in accordance with the applicable codes and regulations. These aboveground storage tanks are intended for installation in accordance with NFPA 30, 30A, 31 and UFC Appendix II-F.

### **V.4. FOUNDATION**

- V.4.1. The foundation for the tank/pump-engine must be designed (and approved by tank manufacturer) to support the tank, pump-engine, and enclosure plus the weight of the maximum amount of product the tank will be storing. The foundation design must also include provision for draining

# *JEA Water and Wastewater Standards*

## *470 Emergency Pump Engines*

surface water away from the tank to minimize the risk of fuel accumulation under the tank from overflow or spills.

V.4.2. The tank foundation's sub-grade shall be over undisturbed earth or compacted fill, free of organic material. Provide a minimum 6-inch thick granular sub-grade, compacted and graded to a level uniform sub-surface prior to the cast slab placement or pouring of the cast-in-place slab. Surface under the foundation shall be flat within 1/16 inch per foot. An alternative to pouring the slab in the field is to purchase a pre-cast slab from the manufacturer.

V.4.3. The legs of all tanks shall be grouted to provide a uniform load distribution on legs and foundations.

### **V.5. ELECTRICAL**

V.5.1. Electrical service and fuel piping to the pumps unit shall be installed in accordance with the requirements of NEC and NFPA and local code requirements.

V.5.2. All electrical devices used with or located within 20 feet of the fuel tank shall conform to NFPA 70 hazardous locations. All electric conduits and wiring connected to the tank shall be explosion proof and in strict accordance with NEC class-1, division 1 or local standards, whichever is stricter.

V.5.3. Electrical grounding is required for flammable liquid fuel tanks. Tanks shall be provided with two grounding lugs welded to the nipples on tank top.

### **V.6. TESTING**

The tank shall be shipped pre-assembled and shop tested. Upon completion of installation, contractor shall pressure test the primary steel tank to 3 psig. This test shall be performed under the supervision and guidance of the manufacturer's representative and in the presence of the JEA's representative.

### **V.7. WARRANTY**

Tank manufacturer shall provide its standard 30 year warranty

## **VI. TESTING REQUIREMENTS**

Prior to acceptance of the installation, the emergency pump-engine shall be tested at the job site to show it is free of any defects and will start automatically and pump the design capacity of the station. Per the discretion of the JEA representative the contractor shall be required to pump down the wet well or booster station by pass and no-flow situations. Prior to acceptance, any defects which become evident during this test shall be corrected at no additional expense to JEA.

## **VII. COATINGS**

Engine, pump, skid/ frame, and any ferrous metal surface not to exceed 150 degree Fahrenheit shall be coated per the following specification or JEA approved equal. Surface preparation: Protect all surfaces from preparation procedures. Solvent clean all surfaces to be coated utilizing Devco Coatings Devprep 88 Heavy Duty Cleaner per SSPC-SP-1 Cleaning Standard. Abrasive blast per SSPC-SP-6 Commercial Blast as a minimum to all surfaces to be coated. All surfaces shall be clean and dry prior to the applications of all coatings. Any surfaces that are not to be coated shall be protected. Primer Coat: Apply Devco Coatings Catha-Coat 303H Reinforced Inorganic Zinc Primer applied at 2.0-4.0 mils dry film thickness. Intermediate Coat: Apply Devco Coatings Bar-Rust 236 Multi-Purpose Epoxy Coating applied at 2.0-4.0 mils dry film thickness. Finish Coat: Apply Devco coatings Devthane 379UVA Aliphatic Urethane Glass Enamel applied at 2.0-4.0 mils dry film thickness. All ferrous metal that exceed 150 degree Fahrenheit (exhaust manifold and or muffler pipe) must be coated with hi-heat aluminum. Hi-heat

## *JEA Water and Wastewater Standards 470 Emergency Pump Engines*

aluminum shall be applied to surface prior to any other coating. Once applied cover to protect the surface and do not allow for overspray of other coatings.

### **VIII. START-UP**

On completion of the installation, the initial start-up shall be performed by a factory trained representative of the pump engine supplier. At the time of start-up, operating instructions and maintenance procedures shall be thoroughly explained to the operating personnel. On turnkey projects the contractor shall be responsible for providing a full tank of fuel for start-up and maintain a full tank until unit/ facility is accepted.

## **471 – BYPASS PUMPING REQUIREMENTS**

### **IX. SCOPE OF WORK**

IX.1. Required for all bypass operations as determined by JEA.

IX.2. 2N+1 or 300% redundancy shall be required at all times.

IX.2.1. A minimum of 2N or 200% redundancy must be maintained and operational at all times at the bypass site, if the bypass site does not have space allowance for 2N+1 or 300% redundancy. This must be preapproved by JEA.

IX.2.1.1. If space does not allow for 2N+1 or 300% redundancy onsite, the addition redundant equipment must be stored at the nearest JEA facility and accessible in such a way as to not impede access or delivery to the site.

IX.3. CONTRACTOR shall furnish, install, operate, maintain, and remove a temporary station bypass pumping system.

IX.4. Bypass pumping shall be required to operate 24 hours per day.

### **X. SUBMITTALS**

X.1. Submit signed and sealed hydraulic calculations by Florida licensed Professional Engineer to JEA for review. Include detailed plans and descriptions outlining all provisions and precautions to be taken by CONTRACTOR to establish compliance with this Section. The bypass pumping system design shall be reviewed and verified by CONTRACTOR's operational vendor, and system layout drawings shall be submitted to for review and approval.

X.2. The bypass plan shall include, but is not limited to, the following information:

X.2.1. Configuration of pumps, piping and fuel storage

X.2.2. Bypass plan shall include the locations and configuration of the proposed bypass pumps, bypass piping, and tie-in connection.

X.2.3. Size, materials, location, elevations, and method of installation of all suction and discharge piping

X.2.4. Bypass pump size, capacity, number of each size to be onsite, and fuel requirements

X.2.5. Pump curves showing pump operating conditions

X.2.6. Overflow locations.

X.2.7. Level-monitoring and pump control equipment, including hydraulic calculations of the critical control and alarm elevations in the junction manhole.

# *JEA Water and Wastewater Standards*

- X.2.8. A minimum of eight (8) monitoring and alarm conditions, automatic communication equipment and alarm response protocols
- X.2.9. Equipment and pipe supports, anchoring requirements and pipe restraint methods;
- X.2.10. Method of noise control for each pump
- X.2.11. Schedule of installation and maintenance of bypass pumping equipment and piping.
  - X.2.11.1. Schedule to include documented daily operational checks by CONTRACTOR.
- X.2.12. Maintenance of Traffic Plan and Permit for Bypass Operation

## **XI. QUALITY ASSURANCE**

- XI.1. The design, installation and operating of the temporary pumping system shall be CONTRACTOR'S responsibility. CONTRACTOR shall employ the service of a vendor who can demonstrate and validate the design and operations of the temporary bypass pumping system. The vendor shall provide at least five project references of similar size and complexity as this project, performed by vendor's firm within the past three (3) years. The bypass system shall meet the requirements of all codes and regulations by agencies having jurisdiction.
- XI.2. All single points of failure such as, but not limited to, air compressors shall have redundancy.

## **XII. BYPASS DESCRIPTION**

- XII.1. The bypass pumping system shall have a minimum firm capacity based on the location's design peak hour flowrate (PHF).
- XII.2. CONTRACTOR shall provide all pipeline plugs, pumps to handle average and peak flows, controls, monitoring devices, and temporary discharge piping to ensure that the design flows can be safely diverted.
- XII.3. CONTRACTOR shall provide a standard operating procedure for the bypass pumping system and have it available in a readily accessible location at the bypass pumping site at all times.

## **XIII. PRODUCTS**

### **XIII.1. PUMP SYSTEM**

- XIII.1.1. All pumps used shall be fully-automatic, self-priming units that do not require the use of foot-valves or vacuum pumps in the priming system. The pumps shall be diesel powered. All pumps used must be constructed to allow dry running for long periods of time to accommodate the cyclical nature of influent flows.
- XIII.1.2. All intake and discharge valving shall be secured in such a way to prevent unintended operation.

# *JEA Water and Wastewater Standards*

- XIII.1.3. CONTRACTOR shall provide the necessary instrumentation and controls for starting/stopping each pump and for monitoring sewage level, pump status, critical engine functions, battery status, fuel level.
- XIII.1.4. Local audible and visible alarms shall be provided, and automatic communication for alarms shall be by cellular telephone autodialing system with at least ten (10) programmable emergency contact phone numbers.
- XIII.1.5. Critical spare parts as identified by manufacturer for the pumps and piping shall be kept onsite as required. All equipment necessary for the safe and efficient replacement of each pump and accessories shall be maintained on site.
- XIII.1.6. All equipment or piping failures or malfunctions shall be corrected immediately.
- XIII.1.7. CONTRACTOR is advised that there is no control over the maximum flow that will occur in the sewer system.
- XIII.1.8. It is essential to the operation of the existing sewer system that there is no interruption in the flow of wastewater for the duration of the bypass period. CONTRACTOR shall provide, maintain, and operate all temporary facilities such as pumping equipment, piping, valves, plugs, all necessary power, and all labor and equipment necessary to intercept the sewage flow before it overflows the influent gravity system or interferes with the work, direct it past the work, and discharge it to the existing downstream sewer system.
- XIII.1.9. CONTRACTOR shall provide all necessary means to safely convey and protect the wastewater past the work area. CONTRACTOR will not be permitted to stop or impede the sewer system flow under any circumstance.
- XIII.1.10. CONTRACTOR shall protect all water resources wetlands and other natural resources from wastewater overflows or hazardous liquid spills, including fuels, lubricants and coolants.

## **XIII.2. PUMP DISCHARGE**

- XIII.2.1. The temporary bypass piping shall be as shown on the drawings, shall be of sound material and shall not leak during operation. Joints shall be supported and restrained to preclude movement or separation. Under no circumstances will aluminum "irrigation" type piping or solvent-weld PVC pipe be allowed.
- XIII.2.2. A properly-sized air relief valve shall be provided at each local high point of the temporary bypass piping.
- XIII.2.3. Layflat hose will not be accepted.

## **XIV. EXECUTION**

### **XIV.1. INSTALLATION**

- XIV.1.1. System layout shall provide for ready removal and replacement of every pumping unit without affecting the others.

# *JEA Water and Wastewater Standards*

- XIV.1.2. Protective barriers and covers shall be installed to prevent debris of any type from entering the piping system. Any debris inadvertently allowed into the system shall be immediately removed.
- XIV.1.3. Pumps shall not be closer than 100 feet from any residence unless not possible based on bypass location and shall not exceed the noise limit of 85 dBA at a distance of 5 feet from any part of the unit.
- XIV.1.4. When working inside the collection system or pump station, CONTRACTOR shall exercise caution and comply with the OSHA requirements for confined spaces and in the potential presence of combustible or oxygen-deficient atmospheres.
- XIV.1.5. CONTRACTOR shall be responsible for furnishing the necessary labor and supervision to set up and operate the pumping system. The system shall be fully inspected daily to ensure that the system is working correctly.

## **XIV.2.FLOW CONTROL MEASURES**

- XIV.2.1. CONTRACTOR shall be responsible and liable for any wastewater overflows resulting from inadequate design, construction, maintenance or operation of the bypass system, including reporting to the State of Florida and any resulting fines, damages and cleanup costs.

## **XIV.3.BYPASS SYSTEM MONITORING**

- XIV.3.1. CONTRACTOR to furnish all Labor, Materials, Equipment, including telemetry, floats and piping for bypass pumping:

## **XIV.4.TELEMETRY/ CALL-OUTS:**

- XIV.4.1. Install normally open contacts in each pump, including the wiring connections to the pump, for the following faults for all pumps.
  - XIV.4.1.1. Pump Fault
  - XIV.4.1.2. Pump not in auto
  - XIV.4.1.3. Pump running
- XIV.4.2. The contacts must be wired by the pump representative to operate as follows; to be held closed at all times while the power is on, and when one of the faults loses power, it will send a signal back to the SCADA.
- XIV.4.3. Provide a field demonstration test with JEA representative of all I/O within the panel
- XIV.4.4. Integration to JEA SCADA
  - XIV.4.4.1. Bypass pumping system may be integrated into the JEA SCADA system for JEA operations 24/7 monitoring and trending ability. JEA O&M will make determination on case by case basis prior to solicitation based on criticality of bypass.
  - XIV.4.4.2. JEA shall run wires from the SCADA system and terminate to the opposite side of the installed contacts for bypasses that require it.

**XIV.5.REMOVAL AND RESTORATION**

XIV.5.1. CONTRACTOR shall remove all pumping system components and restore any modifications to the existing structure as directed by JEA. Any soil containing grease, oil, or fuel from the pump engines shall be removed from the site and replaced with topsoil.

XIV.5.2. All sewer plugs and other bypass system appurtenances shall be removed, and any damage to the station, gravity sewer pipes or manhole shall be repaired.



SECTION V – RECLAIMED WATER DISTRIBUTION SPECIFICATIONS

701 - Reclaimed Water Piping

702 - Reclaimed Water Meters, Valves and Appurtenances

703 - Reclaimed Water Delivery Stations

*Blank Page*



## **701 - RECLAIMED WATER PIPING**

### **I. GENERAL REQUIREMENTS**

#### **I.1. SCOPE OF WORK**

The Contractor shall furnish and install a reclaimed water piping system, complete, tested and ready for operation. The work shall also include such connections, reconnections, temporary service and all other provisions in regard to the existing operation and modification as is required to perform the new work. All references to industry standards (ASTM, ANSI, AWWA, etc.) shall be to the latest revision, unless otherwise stated. Only those materials included in the JEA Water and Sewer Standards Manual shall be installed. All materials shall be new, unless specifically called for otherwise.

#### **I.2. PROJECT SCHEDULE AND COOPERATION**

The project schedule shall be established on the basis of working a normal work schedule including five days per week, single shift, eight hours per day or four days per week, single shift, ten hours per day. Unless approved otherwise by JEA, normal or general items of work, such as leakage and pressure testing, density testing and final inspections, shall be scheduled during the normal work schedule. Due to operational and manpower limitation on the JEA systems, JEA will require the contractor to perform work outside of the normal work schedule. These operational and manpower limitations, including but not limited to, line filling and flushing operation, tie-in work (TS&V, cut-in work or other tie-in work) and other phases of the work which may impact the continued (non-interruptible) service to existing JEA customers. The contractor shall plan and anticipate the cost impact of these system limitations and provide such work or services at no additional cost to JEA.

#### **I.3. SHOP DRAWING SUBMITTALS**

Actual catalog data, brochures and descriptive literature will not be required for items of standard usage which meet the requirements of Section 701 of the JEA Water and Sewer Standards Manual. Any specialty item not shown in this manual will require a complete shop drawing submittal. The Engineer may at any time require the Contractor to provide a complete a detailed shop drawing submittal for any material which may, in the Engineer's opinion, not be in compliance with the JEA Water and Wastewater Standards.

#### **I.4. AS-BUILT DRAWING**

As-built drawings are required on all water, wastewater and reclaimed water projects, including projects for JEA, City of Jacksonville, JTA, DOT, private developments, (utilities to be dedicated to JEA), and other city authorities, etc. As-built drawings shall be in accordance with specification Section 501, entitled "As-built Drawings". As-built drawings shall be reviewed and approved by JEA. The cost to provide as-built drawings shall be included as part of the related work requirements or general conditions for the utility work.

#### **I.5. WARRANTY**

The Contractor shall provide to JEA a two (2) year unconditional warranty after substantial project completion or acceptance or any designated portion thereof. The warranty shall include materials and installation and shall constitute complete replacement and delivery to the site of materials and installation of same to replace defective materials or defective workmanship with new materials/workmanship conforming to the specifications.

#### **I.6. INSPECTION CHECKLISTS**

# *JEA Water and Wastewater Standards*

## *701 Reclaimed Water Piping*

Contractor shall schedule a final walk through (prior to substantial completion) in order to create a punch list for each project. List of attendees shall include but not be limited to the Contractor's representative, JEA representative (ie. project inspector), and designated JEA Operation personnel. The Contractor's representative shall complete the associated JEA Final Inspection Checklist for each and have the JEA attendees provide original signatures/names on the signature block.

## **II. MATERIALS**

Pipe materials and appurtenances, installation and construction details, (plates), shall comply with the requirements of Section 350, entitled "Potable Water Piping", except as noted below.

### **II.1. COLOR CODE REQUIREMENTS**

Pantone purple (522C) color shall be utilized, in lieu of the blue color, for color coding the materials.

### **II.2. MARKING FOR DUCTILE IRON PIPE**

All ductile iron pipe above ground (including bridge crossings) shall be color labeled "RECLAIMED WATER" stenciled in the center of each joint of pipe utilizing an oil based paint. Stenciled lettering shall be 4-inch (minimum), high lettering and be pantone purple.

## **III. INSTALLATION**

Pipe materials and appurtenances, installation and construction details, (plates), shall comply with the requirements of Section 350, entitled "Potable Water Piping", except as noted below.

### **III.1. RECLAIMED WATER MAIN AND POTABLE WATER MAIN SEPARATION REQUIREMENTS**

The minimum separation requirements between reclaimed water piping and potable water mains shall be as outlined in specification Section 350 and Detail Nos. W-10 and W-11. A minimum horizontal separation of 3 feet (outside to outside) shall be maintained between reclaimed water mains and sewers or force mains.

## **IV. TESTING**

### **IV.1. SWABBING**

The purpose of swabbing a new pipeline is to conserve water while thoroughly cleaning the pipeline of all foreign material, sand, gravel, construction debris and other items not found in a properly cleaned system. Prior to pressure testing of a new pipeline swabbing shall be utilized as specified on the construction plans for each project. Swabbing details, Chapter VIII, Plates W-45, W-45A, W-45B, W-45C and W-45D.

IV.1.1. New water, sewer force, and reclaim mains greater than 12" I.D. (with exceptions to smaller pipe lines as deemed necessary by JEA) shall be hydraulically cleaned with a polypropylene swabbing device to remove dirt, sand and debris from main.

IV.1.2. If swabbing access and egress points are not provided in the design drawings, it will be the responsibility of the CONTRACTOR to provide temporary access and egress points for the cleaning, as required.

IV.1.3. Passage of cleaning poly swabs through the system shall be constantly monitored, controlled and all poly swabs entered into the system shall be individually marked and identified so that the exiting of the poly swabs from the system can be confirmed.

# *JEA Water and Wastewater Standards*

## *701 Reclaimed Water Piping*

- IV.1.4. Cleaning of the system shall be done in conjunction with, and prior to, the initial filling of the system for its hydrostatic test.
- IV.1.5. The Contractor shall insert flexible polyurethane foam swabs (two pounds per cubic foot density) complete with rear polyurethane drive seal, into the first section of pipe. The swabs shall remain there until the pipeline construction is completed. A JEA representative shall be present for the swabbing process including swab insertion and retrieval.
- IV.1.6. The line to be cleaned shall only be connected to the existing distribution system at a single connection point.
- IV.1.7. Locate and open all new in-line valves beyond the point of connection on the pipeline to be cleaned during the swabbing operation.
- IV.1.8. At the receiver or exit point for the poly swab, the CONTRACTOR is responsible for creating a safe environment for collection of debris, water and the swab. Considerations shall be made for protecting surrounding personnel and property and safe retrieval of the swab.
- IV.1.9. Only with JEA personnel on-site shall the supply valve from the existing distribution system be operated. Cleaning and flushing shall be accomplished by propelling the swab down the pipeline to the exit point with potable water. Flushing shall continue until the water is completely clear and swab(s) is/are retrieved.
- IV.1.10. Re-apply a series of individual swabs in varying diameters and/or densities as required, to attain proper cleanliness of pipeline.
- IV.1.11. Swabbing speed shall range between two and five feet per second.
- IV.1.12. After the swabbing process, pressure testing and disinfection of the pipe shall be completed in accordance with this manual.

### **IV.2. DISINFECTION REQUIREMENTS**

Disinfection of materials and bacteriological clearance is not required for the reclaimed water system.

### **IV.3. FLUSHING REQUIREMENTS**

Flushing of the reclaimed water system is required utilizing either potable water or reclaimed water, (when available).

*Blank Page*

## **702 - RECLAIMED WATER METERS, VALVES AND APPURTENANCES**

### **I. GENERAL**

#### **I.1. SCOPE OF WORK**

The Contractor shall furnish, install and test all gate valves, check valves and other special valves and appurtenances as shown on the drawings and herein specified. All references to Industry Standards (ASTM, ANSI, AWWA, etc.) shall be to the latest revision unless otherwise stated. Only those materials included in the JEA Water and Wastewater Standards Manual shall be installed. All materials shall be new unless specifically called for otherwise. The reclaimed water customer shall be responsible for the installation, maintenance and periodic testing of a backflow prevention device (BPD) on the potable water service line, as specified in JEA's cross connection control rules and regulations.

#### **I.2. SHOP DRAWING SUBMITTALS**

Actual catalog data, brochures and descriptive literature will not be required for items of standard usage which meet the requirements of Chapter X. and XI. of the JEA Water and Wastewater Standards Manual. Any specialty item not shown in this manual will require a complete shop drawing submittal. The Engineer may at any time require the Contractor to provide a complete detailed shop drawing submittal for any material which may, in the Engineer's opinion, not be in compliance with the JEA Water and Wastewater Standards.

#### **I.3. LOCATING MARKERS FOR VALVES & VACANT LOT SERVICES**

##### **I.3.1. VALVE MARKERS**

A 'V' cut shall be carved in the curb closest/adjacent to a below grade valve. This 'V' cut shall be painted pantone purple. Reclaimed water services serving vacant lots (service not in use), shall include an "R" cut in the curb (closest to the meter box), and painted pantone purple.

##### **I.3.2. MARKET BALLS**

A pantone purple reclaimed water marker ball shall be installed on all buried valves. Marker ball shall be as shown on Plate W-18 of the Water & Reclaim Construction Details.

#### **I.4. WARRANTY**

The Contractor shall supply to JEA a two (2) year unconditional warranty after substantial project completion or acceptance or any designated portion thereof. The warranty shall include materials and installation and shall constitute complete replacement and delivery to the site of materials and installation of same to replace defective materials or defective workmanship with new materials/workmanship conforming to the specifications.

#### **I.5. INSPECTION CHECKLISTS**

Contractor shall schedule a final walk-through (prior to substantial completion) in order to create a punch list for each project. List of attendees shall include but not be limited to the Contractor's representative, JEA representative (ie. project inspector), and designated JEA Operation personnel. Contractor shall be required to provide a crew complete with all necessary equipment to allow observation/operation of each new and



# ***JEA Water and Wastewater Standards***

## ***702 Reclaimed Water Meter, Valves and Appurtenances***

rehabilitated fire hydrant, meter box and valve. The Contractor's representative shall complete the associated JEA Final Inspection Checklist for each new or rehabilitated fire hydrant, meter box and valve, and have the JEA attendees provide original signatures/names on the signature block. The JEA representative shall scan the checklists and ensure the documents are filed in the electronic file folder for the project.

### **II. RECLAIMED WATER METERS AND METER BOXES**

#### **II.1. RECLAIMED WATER METER STANDARDS**

Reclaimed water meters and meter boxes shall conform to potable water meter standards specified in Section 351 Water Meters, Valves and Appurtenances of this manual.

#### **II.2. RECLAIMED WATER METER LOCATIONS**

Reclaimed water meter boxes or services shall be constructed similar to domestic water services and shall be located on the opposite side of the customer's property, unless approved otherwise by JEA.

### **III. VALVES AND APPURTENANCES**

#### **III.1. RECLAIMED VALVES AND APPURTENANCES STANDARDS**

All valves and appurtenances, installation and construction details (plates), shall comply with the requirements of Chapter III.2. Section 351, entitled "Water Valves and Appurtenances", except as noted below:

#### **III.2. PAINTING OF VALVES AND VALVE BOX LIDS**

The top side of all reclaimed water valve box covers and the inside of the top section of the valve box shall be painted pantone purple. Oil based, traffic-rated paint shall be used.

#### **III.3. HYDROSTATIC AND LEAKAGE TEST**

The Contractor shall be required to perform a separate hydrostatic/leakage field test on each valve installed to insure valves are bubble tight. The duration of this test shall be 15 minutes at 150 psi and conform to AWWA C504. The method of performing this test shall be left up to Contractor with the Engineer's approval. The failure of the valve to perform will result in its removal from the job site and replacement by the Contractor at the contractor's expense.

#### **III.4. LABELING VALVE COVERS**

The top of the valve covers shall say "RECLAIMED" and be painted pantone purple.

#### **III.5. DISINFECTION REQUIREMENTS**

Disinfection of materials and bacteriological clearance is not required for the reclaimed water system.

#### **III.6. VALVE TAGS**

Provide brass identification tag with "RECLAIMED", valves size, valve type and direction and number of turns to open. Provide a ¼ inch hole in the brass tag and attach the tag to the end of the locate wire (twist wire around tag). Tag shall be 2- inch diameter and ⅛ inch thick brass with a ¼ inch hole.

#### **III.7. CORP STOPS**

The body of the valve shall be marked as reclaimed water.

*JEA Water and Wastewater Standards  
702 Reclaimed Water Meter, Valves and Appurtenances*

**III.8. CURB STOPS**

The tee head shall include "RW" or JEA approved equal which designates it as reclaimed water valve.

**IV. INSPECTION CHECK LISTS AND REPORTS**

# JEA Water and Wastewater Standards

## 702 Reclaimed Water Meter, Valves and Appurtenances

### IV.1. VALVE INSPECTION CHECKLIST

Project Name: \_\_\_\_\_

Street/Intersection/Address Location: \_\_\_\_\_

Availability Number: \_\_\_\_\_ Project Number: \_\_\_\_\_ Valve Number: \_\_\_\_\_

Date/Time: \_\_\_\_\_

STA: \_\_\_\_\_

Offset: \_\_\_\_\_

Valve Size: \_\_\_\_\_

Valve Type: \_\_\_\_\_

Valve Depth to Nut (inches): \_\_\_\_\_

Number of Turns to open (count): \_\_\_\_\_

Valve use:  Mainline  Independent  Stub  Fire line

Service:	<input type="checkbox"/>	Potable Water
	<input type="checkbox"/>	Reclaimed Water
	<input type="checkbox"/>	Wastewater
Location:	<input type="checkbox"/>	Paved Area
	<input type="checkbox"/>	Grassed Area
Pad:	<input type="checkbox"/>	Concrete
	<input type="checkbox"/>	Asphalt
	<input type="checkbox"/>	N/A
Cover at Finished Grade:	<input type="checkbox"/>	Yes
	<input type="checkbox"/>	No - adjust per spec
Color Coded Cover per spec:	<input type="checkbox"/>	Yes
	<input type="checkbox"/>	No – provide color coded cover
Brass Tag Affixed:	<input type="checkbox"/>	Yes
	<input type="checkbox"/>	No
If No, is this a fire hydrant branch line?:	<input type="checkbox"/>	Yes
	<input type="checkbox"/>	No - provide brass tag per spec
Valve nut accessible:	<input type="checkbox"/>	Yes
	<input type="checkbox"/>	No - adjust per detail
Extension Provided (> 30 inches depth to nut)	<input type="checkbox"/>	Yes
	<input type="checkbox"/>	No--provide extension per spec.
Open Direction	<input type="checkbox"/>	Left
	<input type="checkbox"/>	Right – replace per spec

***JEA Water and Wastewater Standards***  
***702 Reclaimed Water Meter, Valves and Appurtenances***

Valve exercised (Start closed then open fully):	<input type="checkbox"/>	Yes
	<input type="checkbox"/>	No
Valve position (after exercised):	<input type="checkbox"/>	Open (mainline / independent / fire)
	<input type="checkbox"/>	Partially closed (Stub)
Locate wire accessible in jacket	<input type="checkbox"/>	Yes
	<input type="checkbox"/>	No
Locate wire color coded	<input type="checkbox"/>	Yes
	<input type="checkbox"/>	No

Comments: \_\_\_\_\_  
\_\_\_\_\_  
\_\_\_\_\_

Contractor Representative: \_\_\_\_\_  
Signature & Printed Name

JEA Inspector: \_\_\_\_\_  
Signature & Printed Name

JEA O&M representative: \_\_\_\_\_  
Signature & Printed Name

Commissioned Date: \_\_\_\_\_

# JEA Water and Wastewater Standards

## 702 Reclaimed Water Meter, Valves and Appurtenances

### IV.2. AIR RELEASE VALVE INSPECTION CHECKLIST

Project Name: \_\_\_\_\_

Street/Intersection/Address Location: \_\_\_\_\_

Availability Number: \_\_\_\_\_ Project Number: \_\_\_\_\_ ARV Number: \_\_\_\_\_

Date/Time: \_\_\_\_\_

STA: \_\_\_\_\_

Offset: \_\_\_\_\_

ARV Size (Inch): \_\_\_\_\_

Service:	<input type="checkbox"/>	Potable Water
	<input type="checkbox"/>	Reclaimed Water
	<input type="checkbox"/>	Wastewater
Connection:	<input type="checkbox"/>	Offset connection
	<input type="checkbox"/>	Direct connection (i.e. vault over main)
Vault Cover elevation:	<input type="checkbox"/>	Finish Grade
	<input type="checkbox"/>	Below/above finish grade – adjust per spec
Vault box interior lined:	<input type="checkbox"/>	Yes
	<input type="checkbox"/>	No – line per spec
	<input type="checkbox"/>	Not applicable – water, reclaimed or chilled main
Clearance - bottom of vault cover and top of ARV	<input type="checkbox"/>	8 inches or greater
	<input type="checkbox"/>	Less than 8 inches – adjust per detail
Valve position:	<input type="checkbox"/>	Open
	<input type="checkbox"/>	Closed
Stainless Steel Ball Valves	<input type="checkbox"/>	Yes
	<input type="checkbox"/>	No - replace per spec
Stainless steel piping or fittings	<input type="checkbox"/>	Yes
	<input type="checkbox"/>	No - replace per spec
Locate wire accessible in box	<input type="checkbox"/>	Yes
	<input type="checkbox"/>	No
Locate wire color coded	<input type="checkbox"/>	Yes
	<input type="checkbox"/>	No

Comments:

\_\_\_\_\_

\_\_\_\_\_

*JEA Water and Wastewater Standards*  
*702 Reclaimed Water Meter, Valves and Appurtenances*

Contractor Representative:

---

---

Signature & Printed Name

JEA Inspector:

---

Signature & Printed Name

JEA O&M representative:

---

Signature & Printed Name

Commissioned Date:

---

# JEA Water and Wastewater Standards

## 702 Reclaimed Water Meter, Valves and Appurtenances

### IV.3. LOCATE WIRE BOX INSPECTION CHECKLIST

Project Name: \_\_\_\_\_

Street/Intersection/Address Location: \_\_\_\_\_

Availability Number: \_\_\_\_\_ Project Number: \_\_\_\_\_ Date/Time: \_\_\_\_\_

STA: \_\_\_\_\_ Offset: \_\_\_\_\_

Service:	<input type="checkbox"/>	Potable Water
	<input type="checkbox"/>	Reclaimed Water
	<input type="checkbox"/>	Wastewater
Curb Stamp w/Color Coding:	<input type="checkbox"/>	Yes
	<input type="checkbox"/>	No - Fix
Cover at Finished Grade	<input type="checkbox"/>	Cover above finish grade--adjust per spec.
	<input type="checkbox"/>	Cover below finish grade--adjust per spec.
Frame condition:	<input type="checkbox"/>	Good
	<input type="checkbox"/>	Cracked/broken - provide replacement
	<input type="checkbox"/>	Offset - needs resetting/re-grouting
Locate wire accessible in box:	<input type="checkbox"/>	Yes
	<input type="checkbox"/>	No, full of debris - excavate debris
Locate wire properly color coded:	<input type="checkbox"/>	Yes
	<input type="checkbox"/>	No--replace per spec
Locate wire signal verified:	<input type="checkbox"/>	Yes
	<input type="checkbox"/>	No, lined, fiberglass or polymer concrete
	<input type="checkbox"/>	No--repair per spec

Comments: \_\_\_\_\_

Contractor Representative: \_\_\_\_\_  
*Signature & Printed Name*

JEA Inspector: \_\_\_\_\_  
*Signature & Printed Name*

JEA O&M representative: \_\_\_\_\_  
*Signature & Printed Name*

Commissioned this date: \_\_\_\_\_  
*Signature & Printed Name*

## **703 - RECLAIMED WATER DELIVERY STATIONS**

### **I. GENERAL**

#### **I.1. SCOPE OF WORK**

All Reclaimed Delivery Stations in JEA's service area shall conform to section 703. The Contractor shall furnish, install, test and place in operation the reclaimed delivery station shown on the drawings and specified hereinafter. All applicable sections of the City of Jacksonville Standard Specifications and JEA Water and Wastewater Standards shall be considered part of this work. All references to Industry Standards (ASTM, ANSI, etc.) shall be to the latest revision unless otherwise stated. Only those materials included in the JEA Water and Wastewater Standards Manual, (including, but not limited to, flow meter, PLC equipment and control panels), shall be installed. All materials shall be new unless specifically called for otherwise.

#### **I.2. PROJECT SCHEDULE AND COOPERATION**

The project schedule shall be established on the basis of working a normal work schedule including five days per week, single shift, and eight hours per day or four days per week, single shift, ten hours per day. Unless approved otherwise by JEA, normal or general items of work, such as T-V inspections, density testing and final inspections, shall be scheduled during the normal work schedule. Due to operational and manpower limitation on the JEA systems, JEA will require the contractor to perform work outside the normal work schedule. These operational and manpower limitations, including but not limited to tie-in work (cut-in work or other tie-in work) and other phases of the work which may impact the continued (non-interruptible) service to existing JEA customers. The contractor shall plan and anticipate the cost impact of these system limitations and provide such work or services at no additional cost to JEA.

#### **I.3. SHOP DRAWING SUBMITTALS**

All structures, flow meter and panels shall require a complete shop drawing submittal, as detailed in this specification for JEA's review and approval prior to the start of construction.

#### **I.4. AS-BUILT DRAWINGS**

As-built drawings are required on all water, wastewater, reclaimed water and chilled water projects, including projects for JEA, City of Jacksonville, JTA, DOT, private developments, (utilities to be dedicated to JEA), and other City Authorities, etc. As-built drawings shall be in accordance with specifications Chapter VI. 1. - Section 501, entitled "As-Built Drawings". As-built drawings shall be reviewed and approved by JEA. The cost to provide as-built drawings shall be included as part of the related work requirements or general conditions for the utility work. The contractor shall submit preliminary "As-Built" drawings to JEA for review prior to reclaimed delivery station pre-start up. JEA will review the preliminary reclaimed delivery station "As-Built" during the pre-start up for accuracy. The preliminary "As-Built" drawing comments will be returned to the contractor following the pre-start up. Once the "As-Built" is finalized and Development has issued the as-built approval letter, the Certificate of Completion (COC) can be processed.

#### **I.5. WARRANTY**

##### **I.5.1. CONTRACTOR WARRANTY**

The Contractor shall supply to JEA a two (2) year unconditional warranty. The warranty shall include materials and installation and shall constitute complete replacement and delivery to the



# *JEA Water and Wastewater Standards*

## *703 Reclaimed Water Delivery Stations*

site of materials and installation of same to replace defective materials or defective workmanship with new materials/workmanship conforming to the specifications.

### **I.5.2. MANUFACTURER WARRANTY**

The equipment manufacturer warranty, unless otherwise stated, shall be warranted to be free of defects in material and workmanship for a period of 24 months from the date of substantial completion.

### **I.6. RECLAIMED DELIVERY STATION INSPECTION CHECKLIST**

Contractor shall schedule a final walk through (prior to substantial completion) in order to create a punch list for each project. List of attendees shall include but not be limited to the Contractor's representative, JEA representative (ie. project inspector), and designated JEA Operation personnel. Contractor shall be required to provide a crew complete with all necessary equipment to allow observation of each new and rehabilitated reclaimed delivery station. The Contractor's representative shall complete the JEA Final Inspection Checklist for each new or rehabilitated reclaimed delivery station, and have the JEA attendees provide original signatures/names on the signature block.

## **II. MATERIALS**

All materials shall consist of JEA approved products and be provided by the contractor. JEA approved products are located within the JEA Approved Materials Catalog. All products shall be free from defects impairing strength and durability and shall be of the best commercial quality for the purpose specified

### **II.1. FLOW METER**

Shall be an ultrasonic or magnetic flow meter (indicating, totalizing, data transmission via SCADA and recording capabilities). Ultrasonic meters shall have 24"Hx24"Wx18"D meter enclosure 1255052 aluminum standard white.

### **II.2. PIPING**

Piping above ground shall be 316 stainless steel SCH40 and piping below ground shall be SCH80 PVC. Fittings shall be ductile iron

### **II.3. PRECAST CONCRETE STRUCTURE**

Precast structure shall meet ASTM C-478 Standard with 4,000LB. Concrete type II cement. All lifting holes and outside inserts shall be filled with non-shrink grout and coat with bituminous waterproofing material. All precast structure joints below top section shall include a 6" wide (min) exterior joint tape (w/primer). Refer to Section 427, Chapter IV.1 WASTEWATER MANHOLES.

### **II.4. HARDWARE**

All hardware shall be type 316 stainless steel.

## **III. ELECTRICAL**

### **III.1. ELECTRICAL SERVICE**

The Contractor shall provide complete new electrical service for each reclaimed delivery station, including coordination of electrical service selection and approval by JEA or the serving electrical utility company. Each reclaimed delivery station electrical service shall include complete primary and secondary electrical

# *JEA Water and Wastewater Standards*

## *703 Reclaimed Water Delivery Stations*

service equipment, metering and installation in accordance with these standards and the serving electrical utility company requirements.

### **III.2. SCADA EQUIPMENT**

#### **III.2.1. QUALIFIED PANEL MANUFACTURERS**

The electrical control panel shall only be manufactured by a JEA approved manufacturer as listed in Section XI Wastewater Approved Materials. JEA approved control manufacturers shall provide shop ULI certification for all control panels prior to JEA site delivery.

#### **III.2.2. PANEL ENCLOSURES**

III.2.2.1. All enclosures and heat shields shall be powder coated white. Before powder coating enclosures they shall be degreased, cleaned and treated with phosphate process.

III.2.2.2. All enclosures shall be Rated NEMA 12/3R.

III.2.2.3. All Enclosures shall be fitted with 3-Point Latch.

III.2.2.4. All enclosures shall have Marine Grade Aluminum heat shields on the top, front, back and side, unless mounted inside a building. They shall be fabricated from .125 Marine Grade Aluminum.

III.2.2.5. Enclosures shall have pockets mounted on the inside of the door.

III.2.2.6. The enclosure shall have a twelve gauge steel, formed, removable sub panel. The sub panel shall be degreased, cleaned, treated with phosphate process, then primed and painted with white industrial grade baked enamel.

III.2.2.7. The maximum size of an aluminum enclosure shall be no taller than 60" high or 60" wide with 12" floor stands for a total height of 60". These enclosures shall be fabricated from .125 Marine Grade Aluminum.

III.2.2.8. Aluminum enclosures with free standing bases shall have the bases manufactured out of 316 stainless steel.

#### **III.2.3. COMPONENTS**

Components to build a control cabinet are classified as sole sourced or non-sole sourced as listed below.

III.2.3.1. Sole Sourced items are items in the drawing's bill of material that shall not be substituted. These items are the radio, PLC, Input/Output modules, SINAUT communication module.

III.2.3.2. Non-sole sourced items such as Power Supply, Transformer, Circuit Protection and others may be substituted for an equivalent device. The specifications of the devices shall meet or exceed the items listed in the bill of material. Any items found to not meet specification must be replaced at the panel builder's expense.

#### **III.2.4. WIRING**

# *JEA Water and Wastewater Standards*

## *703 Reclaimed Water Delivery Stations*

III.2.4.1. All Wire Colors in the panel shall follow the UL508A standards.

III.2.4.2. Wire type #12 AWG and smaller shall be Hook-Up/Lead tinned copper, # 18 AWG stranded is minimum: BELDEN – 35612 Hook-Up Lead-UL AWM Style 3173-XL-DUR or equal.

### III.2.5. CONTROLS

III.2.5.1. All control cabinet wiring to the PLC and control devices shall be 18 AWG and terminated with ferrules.

III.2.5.2. Control Wiring shall be numbered / lettered at each end. Wire numbers / letters shall be Flattened Polyolefin Heat Shrink Markers for Permanent Wire and Cable Identification (Panduit) or JEA approved equal. Pass & Seymour "Legrande" will no longer be acceptable.

### III.2.6. POWER

III.2.6.1. Ampacity rating shall be a maximum of 75C.

III.2.6.2. All wires going from Distribution Block to the Pump Breaker and Motor Contactor shall be sized for 140% of Motors FLA.

### III.2.7. FIELD WIRING

III.2.7.1. All field wiring shall be ground burial rated.

III.2.7.2. All control wires shall be tin plated and a minimum size of #14 AWG or in alignment with local codes.

III.2.7.3. Dielectric grease applied to both ends to prevent corrosion.

III.2.7.4. All control wires shall be labeled at both ends for tracing.

III.2.7.5. Analog wires shall tin plated with a foil and braided shield.

### III.2.8. TERMINALS

Terminals shall be based on the WAGO Top Job S series terminals. The minimum size shall be 4mm. The spring portion of the clamp shall be fabricated of a chrome nickel spring steel of high tensile strength and shall be solid, without perforation. The chrome nickel spring steel spring tension mechanism shall provide the installer the opportunity to directly insert solid or ferruled conductors without having to utilize tooling to open the clamping mechanism. The terminal block shall be designed to accept solid and/or stranded copper conductors without requiring special preparation, such as crimps, ferrules or tinning. Proportional clamping shall ensure mechanical and electrical connection integrity without damage to the conductors of various sizes throughout the rated range. The design of the terminal block shall not prevent or interfere with the use of wire preparation methods, such as crimps, ferrules or tinning. The pullout force shall be a minimum of 6 times that specified in VDE 0611 (Resistance to Vibration Test for Terminal Block). The current bar and clamping yoke shall have traverse grooves to increase the force required for conductor

# ***JEA Water and Wastewater Standards***

## ***703 Reclaimed Water Delivery Stations***

pull out and "Gas tight" connection. The voltage drop also shall remain virtually unchanged. Gas tightness will be per DIN 41640, part 76.

### **III.2.9. COMPONENTS EXTERNAL TO THE PANEL**

#### **III.2.9.1. Floats required:**

- High level float, control valve "off"
- Control float
- Low level float

### **III.2.10. RADIO POLE/TOWER**

The radio pole or tower shall provide communication to the SCADA cabinet to the remote master. To determine if a Pole or Tower is required a Radio Path Study shall first be conducted. The Radio Path Study shall be done using the same type of radio used in the SCADA panel and shall be a minimum of -86DB RSSI. If the height of the minimum -86DB RSSI level is less than or equal to 20' then a 20' Pole shall be used. If the height requirements are over 20' then a Tower shall be used. Refer to drawings for specifications on Pole and Tower. Poles/towers must meet JEA wind load requirements.

## **IV. SITE WORK**

### **IV.1. SITE PLAN**

The site plans shall be designed site specific. The site plan shall indicate the actual site and orientation of all structures, panels and piping, at a minimum.

### **IV.2. GENERAL**

All work shall be in accordance with the following specification sections, at a minimum: Chapter II. 1. - Section 406 - Site Preparation, Cleanup and Restoration, Chapter II. 2. - Section 407- Demolition and Abandonment, Section 408 - Excavation and Earthwork and Chapter II. 5. - Section 437 – Concrete Work. Slope concrete and site to drain towards street or other adjacent, JEA or City owned drainage facility.

### **IV.3. CONCRETE**

All work under this section shall be of 3,000 PSI concrete with reinforcing wire or fiber mesh. Thickness of concrete shall be 6 inches (minimum).

#### **IV.3.1. EXPANSION JOINTS**

Expansion joints shall be pre-formed joint fillers meeting the requirements of AASHO M153 or AASHO 213 and cut to the true shape of the cross section, set to line and grade and held true while the concrete is being placed. The joint shall be edged and finished in a competent manner. These strips shall be left in place and shall be placed adjacent to the paving, curb driveway aprons, structures and pads, or as specified by the Engineer. Expansion Joints which are not adjacent to the structures listed above may be 1 inch by 4 inch pressure treated lumber or other approved materials and shall appear every 18 feet, at a minimum or be placed between truckloads of concrete that exceed the time limits specified in the JEA Water and Wastewater Standards Chapter II. 5. - Section 437 Concrete Work.

#### **IV.3.2. CONTRACTION AND CONSTRUCTION JOINTS**

# ***JEA Water and Wastewater Standards***

## ***703 Reclaimed Water Delivery Stations***

Contraction and construction joints shall be placed and formed by means of an approved jointer template. The stem of the jointer shall be pressed into the freshly finished concrete forming a groove 1/2 inch deep. The edges of the groove and adjacent surface shall be neatly finished. Unless otherwise shown on the plans or designated by the Engineer, these joints shall be placed at 6-foot intervals between expansion joints.

### **IV.3.3. SURFACE REQUIREMENTS**

The concrete shall be given a broom finish. The surface variations shall not be more than 1/4 inch under a ten-foot straight edge, nor more than 1/8 inch on a five foot transverse section. The edge of the concrete shall be carefully finished with an edging tool having a radius of 1/2 inch.

### **IV.4. LANDSCAPING**

Plants shall be of the types and placed in the locations as indicated on JEA's Minimum Standards for Landscaping as included in the Reclaimed Delivery Station Details and as approved by local landscape code enforcement.

### **V. PERMITS**

The Engineer will supply the land-clearing permit. The Contractor shall secure and pay for all plumbing, electrical, right-of-way and other required permits. The Contractor shall make application and pay applicable fees for electric and water meters. The Contractor shall be responsible for all costs associated with utilities used during construction and testing of the pump station. Upon final acceptance or, if approved, following substantial completion of the project, the JEA Pump Station Manager shall, by letter to JEA, transfer services to JEA.

### **VI. RECLAIMED DELIVERY STATION INSPECTION**

The Contractor shall be responsible for conducting the following field acceptance tests and start-up procedures in the presence of a JEA representative. The Contractor shall notify JEA and the Engineer 48 hours prior to start-up. The time and date of this final inspection shall be scheduled by JEA. The Contractor shall furnish all labor, piping, equipment, water and materials required to perform the acceptance testing. The Contractor shall ensure the reclaimed water main is full of water prior to the test. The contractor shall submit proof of compliance with electric site grounding requirements. JEA will complete a final inspection checklist for acceptance. The contractor shall demonstrate that the flow meter and electrical actuated control valve is operational.

### **VII. INSPECTION CHECKLISTS AND REPORTS**

# JEA Water and Wastewater Standards

## 703 Reclaimed Water Delivery Station

### VII.1. RECLAIMED DELIVERY STATION FINAL CHECK LIST

Project Name: \_\_\_\_\_

Street/Intersection/Address: \_\_\_\_\_

Electric Meter # \_\_\_\_\_

STA and Offset \_\_\_\_\_

Elevation of Station \_\_\_\_\_

Flow Meter Serial # \_\_\_\_\_

Control Valve Serial # \_\_\_\_\_

		Pass	Fail
1	All valves operate from the closed to the fully open position	<input type="checkbox"/>	<input type="checkbox"/>
2	All valves seal when closed	<input type="checkbox"/>	<input type="checkbox"/>
3	All valves open turning to the left, and an indicating arrow is cast into the metal	<input type="checkbox"/>	<input type="checkbox"/>
4	All valves are easy to operate and have no sharp protrusions on hand wheels	<input type="checkbox"/>	<input type="checkbox"/>
5	All fasteners are SS, and mountings are tightened correctly	<input type="checkbox"/>	<input type="checkbox"/>
6	Piping is installed plumb with both horizontal and vertical alignment provided	<input type="checkbox"/>	<input type="checkbox"/>
7	Pressure gauge provided	<input type="checkbox"/>	<input type="checkbox"/>
8	All above ground pipe/fittings/valves have approved coating applied (two coats)	<input type="checkbox"/>	<input type="checkbox"/>
9	Flow meter calibrated, tested and functioning properly	<input type="checkbox"/>	<input type="checkbox"/>
8	All pipe/fittings/valves leak free.	<input type="checkbox"/>	<input type="checkbox"/>
9	Provide electronic photos of reuse station showing overall site, valves, panels, etc.	<input type="checkbox"/>	<input type="checkbox"/>
10	Antenna Installed.	<input type="checkbox"/>	<input type="checkbox"/>
11	Contractor has radio communication established to local reuse master radio (JEA to provide master radio coordinates)	<input type="checkbox"/>	<input type="checkbox"/>
12	JEA programed panel and verified operation over SCADA network.	<input type="checkbox"/>	<input type="checkbox"/>
13	Electric meter installed.	<input type="checkbox"/>	<input type="checkbox"/>
14	Concrete pad poured (No cracks or breaks).	<input type="checkbox"/>	<input type="checkbox"/>
15	Aluminum cross bars on rack make sure not too long	<input type="checkbox"/>	<input type="checkbox"/>
16	Wiring Installed Correctly	<input type="checkbox"/>	<input type="checkbox"/>
17	Flow Meter Installed Correctly	<input type="checkbox"/>	<input type="checkbox"/>
18	Flow Meter Sun Shield Installed	<input type="checkbox"/>	<input type="checkbox"/>
19	Control Valve Installed and Operating Correctly	<input type="checkbox"/>	<input type="checkbox"/>
20	Adjust Valve Potentiometer	<input type="checkbox"/>	<input type="checkbox"/>
21	Verify Scaling of Pressure Transmitter	<input type="checkbox"/>	<input type="checkbox"/>
22	Control Structure Grate Composite	<input type="checkbox"/>	<input type="checkbox"/>
23	Verify Floats Manufacture and Operations	<input type="checkbox"/>	<input type="checkbox"/>
24	Floats Adjusted to Correct Elevations	<input type="checkbox"/>	<input type="checkbox"/>
25	As-Builts correct.	<input type="checkbox"/>	<input type="checkbox"/>

OK

Rework Required

*JEA Water and Wastewater Standards  
703 Reclaimed Water Delivery Station*

Contractor Rep:

\_\_\_\_\_  
*Signature* *Print name*

JEA Inspector:

\_\_\_\_\_  
*Signature* *Print name*

JEA O&M Rep:

\_\_\_\_\_  
*Signature* *Print name*

Date Commissioned:

\_\_\_\_\_

Comments:

\_\_\_\_\_  
\_\_\_\_\_  
\_\_\_\_\_  
\_\_\_\_\_  
\_\_\_\_\_  
\_\_\_\_\_

## **SECTION VI – OTHER SPECIFICATIONS**

750 - Small Pipe Horizontal Directional Drilling (Pipe 12 Inches or Less)

755 - Large Diameter Horizontal Directional Drilling (Pipe Larger than 12 Inches)



*Blank Page*

## **750 - SMALL PIPE HORIZONTAL DIRECTIONAL DRILLING (PIPE 12 INCHES OR LESS)**

### **I. GENERAL REQUIREMENTS**

#### **I.1. SCOPE OF WORK**

The work specified in this section consists of furnishing and installing underground utilities using open-cut method or the horizontal directional drilling (HDD) method of installation for pipes 12 inches and less inside diameter (ID), also commonly referred to as directional boring or guided horizontal boring. This work shall include all services, equipment, materials, and labor for the complete and proper installation, testing, restoration of underground utilities and environmental protection and restoration. If warranted by JEA a dual horizontal directional drilling shall be required.

#### **I.2. QUALITY ASSURANCE**

The requirements set forth in this document specify a wide range of procedural precautions necessary to insure that the very basic, essential aspects of a proper directional bore installation are adequately controlled. Strict adherence shall be required under specifically covered conditions outlined in this specification or within any associated permit (i.e.: DEP, DOT, Etc.). Adherence to the specifications contained herein, or the JEA Representative's approval on any aspect of any directional bore operation covered by this specification, shall in no way relieve the Contractor of their ultimate responsibility for the satisfactory completion of the work authorized under the Contract. The HDD contractor shall be responsible for the repair of all damage to private and/or public property (at no expense to JEA). Repair work shall meet all local and state rules and requirements.

#### **I.3. QUALIFICATIONS**

The work specified in this Section requires significant previous experience and expertise in similar work to avoid negative impacts to public safety and the environment. Therefore, the Contractor performing the work shall be qualified, in JEA's judgment, to complete the horizontal directional drilling work specified herein. In order to qualify to perform work specified in this Section the Contractor must provide evidence satisfactory to JEA, including the following:

I.3.1. Contractor to have successfully self-performed at least (5) horizontal directional drilling projects to install product pipe of a similar nominal diameter and length to the proposed project within the past two years. JEA shall have sole authority to determine the adequacy of representative projects.

I.3.2. The Contractor's project manager, superintendent, drill operator, and guidance system operator assigned to horizontal directional drilling shall be experienced in work of this nature and shall have successfully completed similar projects using horizontal directional drilling. The Contractor shall submit substantiating evidence of qualifications, in accordance with the provisions of this Section, with the bid submittal documents. Failure to submit the required documentation will cause the Contractor to be declared nonresponsive. If the Contractor elects to employ a specialist subcontractor(s) to perform horizontal directional drilling, the Contractor shall obtain and submit qualification documents for the subcontractor(s). Subcontractor(s) shall be held to the same requirements as those for the Contractor described herein.

## ***JEA Water and Wastewater Standards 750 Small Pipe Horizontal Directional Drilling (12" or less)***

- I.3.3. All drilling, drill guidance, and pipe joining equipment operators shall be experienced in comparable horizontal directional drilling work, and shall have been fully trained in the use of the proposed equipment by an authorized representative of the equipment manufacturer(s) or their authorized training agents.
- I.3.4. All HDPE/FPVC fusion equipment operators shall be qualified to perform pipe joining using the means, methods and equipment employed by the contractor. Fusion equipment operators shall have current, formal training on all fusion equipment employed the project. Training received more than two years prior to operation of the fusion equipment shall not be considered current. The Contractor shall submit written certification of training provided by the fusion equipment manufacturer.

### **I.4. PROJECT SCHEDULE AND COOPERATION**

The project schedule shall be established on the basis of working a normal work schedule including five days per week, single shift, and eight hours per day or four days per week, single shift, ten hours per day. Unless approved otherwise by JEA normal or general items of work, such as bacteriological testing, leakage and pressure testing, density testing and final inspections, shall be scheduled during the normal work schedule. Due to operational and manpower limitations on the JEA systems, JEA will require the contractor to perform work outside of the normal work schedule. These operational and manpower limitations, including but not limited to, line filling and flushing operation, tie-in work, (cut-in work or other work) and other phases of the work which may impact the continued (non-interruptible) service to existing JEA customers. The contractor shall plan and anticipate the cost impact of these systems limitations and provide such work or services at no additional cost to JEA.

### **I.5. WARRANTY**

#### **I.5.1. CONTRACTOR WARRANTY**

- I.5.1.1. The contractor shall supply to JEA a two (2) year unconditional warranty. The warranty shall include materials and installation and shall constitute complete replacement and delivery to the site of materials and installation of same to replace defective materials or defective workmanship with new materials/workmanship conforming to the specifications.
- I.5.1.2. The contractor shall warrant to JEA that the methods used on the contract, where covered by patents or license agreements, are furnished in accordance with such agreements and that the prices included herein cover all applicable royalties and fees in accordance with such license agreements. The contractor shall defend, indemnify, and hold JEA harmless from and against any and all costs, loss, damage or expense arising out of, or in any way connected with, any claim of infringement of patent, trademark, or violation of license agreement.

#### **I.5.2. PIPE WARRANTY**

The pipe manufacturer shall provide a warranty to the contractor that the pipe conforms to these specifications and that the pipe shall be free from defects in materials and workmanship for a period of two (2) years from the date of substantial completion of the installation. The manufacturer's warranty shall be in a form acceptable to and for the benefit of JEA and shall be submitted by the contractor as a condition of final payment. The manufacturer's warranty to the contractor shall in no way relieve the contractor from its unconditional warranty to JEA.

# *JEA Water and Wastewater Standards*

## *750 Small Pipe Horizontal Directional Drilling (12" or less)*

### **I.6. REFERENCED STANDARDS**

- I.6.1. The work shall conform to applicable provisions of the JEA Water and Wastewater Standards, and the following standards, latest editions, except as modified herein.
- I.6.2. The work shall conform to the following American Water Works Association (AWWA) Standards:
- AWWA C906 Polyethylene (PE) Pressure Pipe and Fittings, 4 inch through 63 inch, for Water Distribution American Society for Testing and Materials (ASTM) Standards.
  - ASTM D638 Standard Test Method for Tensile Properties of Plastics.
  - ASTM D2122 Standard Method of Determining Dimensions of Thermoplastics Pipe and Fittings.
  - ASTM D2683 Standard Specification for Socket-Type Polyethylene Fittings for Outside Diameter-Controlled Polyethylene Pipe and Tubing.
  - ASTM D2837 Standard Test Method for Obtaining Hydrostatic Design Basis for Thermoplastic Pipe Materials.
  - ASTM D3035 Standard Specification for Polyethylene (PE) Plastic Pipe (SDR- PR) Based on Controlled Outside Diameter.
  - ASTM E3261 Standard Specification for Butt Heat Fusion Polyethylene Plastic Fittings for Polyethylene (PE) Plastic Pipe and Tubing.
  - ASTM D3350 Standard Specification for Polyethylene Plastic Pipe and Fittings Materials.
  - ASTM F412 Standard Terminology Relating to Plastic Piping Systems.
  - ASTM F714 Standard Specification for Polyethylene (PE) Plastic Pipe (SDR-PR) Based on Outside Diameter.
  - ASTM F2620 Standard Practice for Heat Fusion Joining of Polyethylene Pipe and Fittings.

### **I.7. PERMITS**

The Contractor shall verify the existence of all permits before commencing any work on the project.

### **I.8. SUBMITTALS (HDD PROJECTS ONLY)**

#### **I.8.1. CONTRACTOR QUALIFICATIONS**

- I.8.1.1. The Contractor shall submit information demonstrating compliance with the Contractor and personnel qualification requirements of this Section. The Contractor shall provide the required qualifications submittals along with the bid.
- I.8.1.2. The Contractor shall submit the following information for each referenced project:
- Name and general description of project.
  - Name, position, address, and telephone number of contact for JEA.
  - Contract start and completion date.
  - Contract type and value.
  - Length and diameter of completed bore(s).
  - Diameter of completed bore(s).

## ***JEA Water and Wastewater Standards***

### ***750 Small Pipe Horizontal Directional Drilling (12" or less)***

- Description of pipe(s).
- Type and manufacturer of drilling and installation equipment used.
- Ground conditions encountered.
- If the referenced project is not yet completed, the Contractor shall include:
- Anticipated completion date.
- Value of work completed to date and anticipated final contract value.

1.8.1.3. The Contractor shall submit the following personnel information:

- Names and resumes, including specific project experience, for the proposed project manager, superintendent, guidance operator, and drill operator, demonstrating that each meets the requirements of this Section.
- Names and qualifications, including specific project experience, for all proposed drilling, drill guidance, and pipe joining equipment operators, including evidence of training in the use of the proposed equipment by an authorized representative of the equipment manufacturer or their qualified agent.

#### **1.8.2. WORK PLAN**

Prior to beginning work, the Contractor must submit to the JEA Representative a work plan detailing the procedure and schedule to be used to execute the project. Horizontal directional drilling shall not commence until the contractor has received written approval of all work plan submittals from JEA.

#### **1.8.3. METHODS:**

The Contractor shall provide complete descriptions of proposed plans, procedures, and personnel, as well as supporting calculations, for the following:

- 1.8.3.1. Drilling operations, addressing: Procedures for pilot hole drilling and reaming. Procedures for tracking and controlling the drilling head location. Procedures for preparing as-builts.
- 1.8.3.2. Drilling fluid management plan.
- 1.8.3.3. Spoils handling and disposal plan.
- 1.8.3.4. Pipe storage and handling, addressing: Means and methods for protecting pipe and ensuring temperature control in accordance with the Contractor's installation calculations.
- 1.8.3.5. Pipeline assembly and installation, addressing: Procedures for pipe joining, pipeline pullback, and pullback monitoring.
- 1.8.3.6. Prevention of inadvertent fluid losses and spills, and contingencies for rapid containment and cleanup, addressing: Measures to mitigate risk of inadvertent fluid returns to surface. Procedures for monitoring and controlling drilling fluid flows and pressures. Equipment, resources, and procedures for identifying, containing, and cleaning up fluid losses and spills.

# *JEA Water and Wastewater Standards*

## *750 Small Pipe Horizontal Directional Drilling (12" or less)*

I.8.3.7. Quality control and testing procedures.

I.8.3.8. Safety plan.

### **I.8.4. SCHEDULE:**

The Contractor shall provide a schedule for all horizontal directional drilling activities commencing with the site preparation and terminating on completion of testing and final acceptance of the installed pipe. The schedule shall address anticipated subsurface conditions and overall project requirements.

### **I.8.5. EQUIPMENT**

The Contractor shall provide the make, model, and technical specifications for each of the following:

- Horizontal directional drill rig.
- Drilling system components.
- Downhole drilling assembly and reaming equipment.
- Downhole pressure sub
- Guidance and control system.
- Pulling head.
- Swivel.
- Rollers.
- Solids separation and drill fluid recirculation systems.
- Pipe fusion equipment.
- Pipe fusion data logger.
- Pipe handling equipment.
- Pigs and pigging equipment.

The Contractor shall provide the following specific equipment information:

- Calibration certification for the pilot bore guidance and control system.
- Calibration certification for the heat fusion data logger.

### **I.8.6. SUPPLEMENTAL WORK PLAN REQUIREMENTS**

The Contractor shall provide the following additional work plan submittals within 30 days of receiving notice to proceed. The submission requirements for additional work plan submittals including number of copies and delivery of submittals shall follow the requirements outlined in the general requirements. Horizontal directional drilling shall not commence until the Contractor has received written approval of all supplemental work plan submittals.

I.8.6.1. The Contractor shall submit traffic control plans for entry and exit pit sites.

I.8.6.2. Plans for mitigating the potential for inadvertent drilling fluid losses to surface, and for rapidly identifying and cleaning up spills near the investigation borings located along the project alignment. Investigation boreholes along the alignment have been backfilled as reported in the Geotechnical Report. The Contractor's work plans shall address the risk that all investigation boreholes may contribute to the risk of drill fluid loss.

## ***JEA Water and Wastewater Standards*** ***750 Small Pipe Horizontal Directional Drilling (12" or less)***

- I.8.6.3. Contingency plan for rapidly identifying, locating, and containing any drilling fluid returns.
- I.8.6.4. The Contractor shall submit a contingency plan to address procedures to be employed in the event any of the listed items occur.
- Utility strike, obstruction, or inability to advance drill pipe.
  - Excessive deviation from proposed line and grade, as described within this Section.
  - Inability to move pipe through borehole during pullback.
  - Settlement or heave of roadways and structures within 50 feet of the alignment

### **I.8.7. SHOP DRAWING SUBMITTALS**

Actual catalog data, brochures and descriptive literature will not be required for items of standard usage which meet the requirements of the JEA Water and Wastewater Standards Manual. Any specialty item not shown in this manual will require a complete shop drawing submittal for any material which may, in the Engineer's opinion, not be in compliance with the JEA Water and Wastewater Standards.

### **I.8.8. CONSTRUCTION RECORDS**

#### **I.8.8.1. Daily Reports**

The Contractor shall maintain daily activity reports throughout all horizontal directional drilling operations, including pipe installation. A sample daily report shall be submitted to JEA for approval prior to the commencement of drilling operations. Daily reports shall be submitted within 24 hours of completion, and shall include, for each drill rod added or withdrawn, or every 30 feet during drilling, pre-reaming, and pullback:

- Downhole tools and equipment in use.
- Description of ground conditions encountered.
- Description of drilling fluid.
- Drilling fluid pumping rate.
- Maximum and minimum downhole fluid pressures.
- Drilling head location - at least every 10 feet along the bore path.
- Drill stem torque.
- Details and perceived reasons for delays greater than one hour other than normal breaks and shift changes.
- Details of any unusual conditions or events.

#### **I.8.8.2. Production and As-Built Drawings**

The Contractor shall maintain at the construction site a complete set of field drawings for recording the as-built conditions. The Contractor shall plot as-built conditions on the field drawings, including the location in plan and elevation of the drill string, reaming head, and installed pipe, at the completion of each production shift. The Contractor shall compile and submit as-built data in accordance with JEA Water and Wastewater Standards Section 501. As-builts shall include all bores successful and failed.

# ***JEA Water and Wastewater Standards***

## ***750 Small Pipe Horizontal Directional Drilling (12" or less)***

### **I.8.8.3. Testing and Quality Control and Assurance Documentation**

The Contractor shall maintain records for all testing and quality control and assurance procedures. The following records shall be provided to JEA or JEA's Representative on the day that information is acquired by the Contractor:

- Manufacturer's Field Reports.
- Test reports.
- Fusion reports. For each weld, provide an electronic and printed report of the downloaded information for each weld.

### **I.9. NOTIFICATIONS**

The JEA representative must be notified 48 hours (minimum) in advance of starting the drilling work. The directional bore shall not begin until the proper preparations (see work plan) for the operation have been completed.

### **I.10. SITE PREPARATION**

I.10.1. Prior to any alterations to work-site, Contractor shall photograph or video tape entire work area. One copy of which shall be given to JEA Representative and one copy to remain with Contractor for a period of two (2) years following the completion of the project.

I.10.2. Contractor shall coordinate utilities locates with Sunshine State One-Call of Florida, Inc., (#811 or web site [www.callsunshine.com](http://www.callsunshine.com)). Once the locate service has field marked all utilities, the Contractor shall verify each utility (including any service laterals, i.e. water, wastewater, cable, gas, electric, phone, etc.) and those within each paved area. Verification may be performed utilizing Ground Penetrating Radar, hand dig, or vacuum excavation. Prior to initiating drilling, the Contractor shall record on the drawings both the horizontal and vertical location of the utilities off of a predetermined baseline. The Contractor shall utilize the Ground Penetrating Radar over the projected bore path whether utilities are located in the horizontal drill pathway or not, in order to reduce the opportunity of conflicting with any unforeseen obstructions.

I.10.3. Work site shall be graded and filled to provide a level working area. No alterations beyond what is required for operations are to be made. Contractor shall confine all activities to designated work areas.

I.10.4. Following drilling operations, Contractor will de-mobilize equipment and restore the work-site to original condition. All excavations will be backfilled and compacted to 95% of original density (at a minimum).

### **I.11. ENVIRONMENTAL PROTECTION**

Contractor shall place silt fence between all drilling operations and any drainage, wetland, waterway or other area designated for such protection by contract documents, state, federal and local regulations. Contractor shall place hay bales, or approved protection, to limit intrusion upon project area. Additional environmental protection necessary to contain any hydraulic or drilling fluid spills shall be put in place, including berms, liners, turbidity curtains and other measures. Contractor shall adhere to all applicable environmental regulations including environmental condition stated in local, state and federal permits. Fuel may not be stored in bulk containers (greater than 25 gallons) within 200' of any water-body or wetland.

### **I.12. SAFETY**



# ***JEA Water and Wastewater Standards***

## ***750 Small Pipe Horizontal Directional Drilling (12" or less)***

Contractor shall adhere to all applicable state, federal and local safety regulations and all operations shall be conducted in a safe manner.

### **I.13. DOMESTIC WATER**

For the supply of domestic water during construction, the contractor shall utilize a JEA meter assembly (meter & backflow device) and pay for all water consumed except in the case where the new water main is connected directly into the active water system for line filling and flushing operation. Un-metered reclaimed water may be utilized for flushing and testing of new reclaimed water mains. Un-accountable domestic water quantities shall be minimized, where possible.

## **II. MATERIALS**

### **II.1. PIPE AND FITTINGS**

#### **II.1.1. HIGH DENSITY POLYETHYLENE (HDPE, PE) PIPE AND FITTINGS**

Materials used for the manufacturer of high density polyethylene pipe and fittings shall be PE3608 or PE4710 high density polyethylene meeting cell classification 345464C per ASTM D3350; and meeting Type III, Class B or Class C, Category 5, Grade P34 per ASTM D1248; and shall be listed in the name of the pipe and fitting Manufacturer in PPI TR-4, Recommended Hydrostatic Strengths and Design Stresses for Thermoplastic Pipe and Fittings Compounds, with a standard grade rating of 1600 psi at 73°F per ASTM D-2837. The Manufacturer shall certify that the materials used to manufacture pipe and fittings meet these requirements.

#### **II.1.2. 2" POLYETHYLENE TUBING LINES (LOW PRESSURE WASTEWATER LINES ONLY)**

Tubing shall be manufactured of PE 4710, High Density Polyethylene (HDPE), in accordance with AWWA C901, ASTM D1248, ASTM D2239, ASTM D2737 and ASTM D3350. The tubing shall have a minimum working pressure of 250 psi. Polyethylene tubing shall be copper tube size or IPS SDR-9 and shall be colored black or green. HDPE pipe shall have ultraviolet (UV) inhibitors for protection against direct sunlight for 1 year. Inserts for polyethylene tubing may be utilized, at contractors' options, and if used, shall be 316 stainless steel. The use of brass fittings (including couplings) is acceptable if not located under the roadway. The use of brass couplings, tees and "Y" fittings are acceptable on poly service tubing, if not located under the roadway. Tubing shall be approved for use with potable water by the National Sanitation Foundation (NSF-14) and shall be continuously marked at intervals of not more than four feet with the following:

- Nominal size
- Pressure rating
- NSF seal
- Manufacturer's name or trademark
- Standard dimension ratio
- ASTM specification

#### **II.1.3. POLYETHYLENE PIPE**

HDPE Pipe shall conform to AWWA C906, DR-11, Ductile Iron Pipe (DIP) size and NSF 61 Standard. Polyethylene pipe shall be manufactured in accordance with ASTM F714, Polyethylene (PE) Plastic Pipe (SDR-PR) Based on Controlled Outside Diameter and shall be so marked. Each

# ***JEA Water and Wastewater Standards***

## ***750 Small Pipe Horizontal Directional Drilling (12" or less)***

production lot of pipe shall be tested for (from material or pipe) melt index, density, % carbon, dimensions and either quick burst or ring tensile strength (equipment permitting).

### **II.1.4. FUSIBLE PVC PIPE**

May be used on potable water, reuse water or wastewater systems. Fusible PVC may be utilized for directional drilling and direct bury applications. Pipe shall meet C-900 pressure class, DR-18 wall thickness and color coded. The pipe shall be marked with the name and location of the manufacturer, pressure rating and size. Unless approved otherwise by JEA, the bending radius, and pulling force are noted in section XI, plate S-21, for dual drill plate S-21A.

### **II.1.5. NOMINAL PIPE SIZES**

Nominal pipe sizes only are indicated on the drawings and bid form. Outside diameter of pipe is generally 1 to 2-inches greater than the nominal pipe diameter. The HDPE pipe size shall be selected (up-sized) to maintain the internal diameter relatively equal to ductile iron sizes.

## **II.2. SERVICE IDENTIFICATION**

Permanent identification of piping service shall be provided by co-extruding multiple equally spaced color stripes into the pipe outside surface or by solid colored pipe shell. The striping material shall be the same material as the pipe material except for color. The following colors shall be used to identify piping service (pressure service):

- Blue – potable water
- Green – wastewater or force main
- Purple – reclaimed water
- Black – raw water
- White – chilled water

## **II.3. MANUFACTURER'S QUALITY CONTROL**

The pipe and fitting manufacturer shall have an established quality control program responsible for inspecting incoming and outgoing materials. Incoming polyethylene materials shall be inspected for density, melt flow rated, and contamination. The cell classification properties of the material shall be certified by the supplier, and verified by Manufacturer's Quality Control.

## **II.4. POLYETHYLENE MECHANICAL JOINT (MJ) ADAPTERS**

Mechanical connections of HDPE pipe to Ductile Iron or PVC piping, mechanical joint fittings, or valves shall be through a fusible mechanical joint. Mechanical joint adapter shall be of the same DR rating as the pipe. Provide the mechanical joint adapter, including but not limited to longer tee bolts or all thread rods with nuts at the mechanical joint bell.

## **II.5. SERVICES FOR WATER AND REUSE**

II.5.1. Polyethylene service line tubing shall conform to Water and Wastewater Standards, Chapter III.1. - Section 350.

II.5.2. Service Connections For Water And Reuse

Services 2" and smaller shall include a fused saddle with 2" outlet brass corporation stop (straight standard pipe thread) and brass bushings shall be used to provide the correct service size. The

# ***JEA Water and Wastewater Standards***

## ***750 Small Pipe Horizontal Directional Drilling (12" or less)***

position of the fused outlet shall be in accordance with water construction detail W-2. The contractor shall supply all adapters, and special connections necessary to transition from the service connection to the JEA standard polyethylene service tubing at both ends. Services are to be in accordance with Plates W-1 through W-4, inclusive. Payment for this item shall be included in the unit price bid amount for the water service.

### **II.6. DRILLING FLUIDS**

Drilling fluids shall be bentonite slurry.

### **II.7. DELIVERY, STORAGE AND HANDLING OF MATERIALS**

II.7.1. Inspect materials delivered to the site for damage. All materials found during inspection or during the progress of work to have cracks, flaws, cracked linings, or other defects shall be rejected and removed from the job site without delay.

II.7.2. Unload and store opposite or near the place where the work will proceed with minimum handling. Store material under cover out of direct sun light. Do not store directly on the ground. Keep all materials free of dirt and debris.

II.7.3. Contractor is responsible for obtaining, transporting and sorting any fluids, including water, to the work site.

II.7.4. Disposal of fluids is the responsibility of the Contractor. Disposal of fluids shall be done in a manner that is in compliance with all permits and applicable federal, state, or local environmental regulations. The bentonite drilling slurry may be recycled for reuse in the hole opening operation, or shall be hauled by the Contractor to an approved location or landfill for proper disposal. Contractor shall thoroughly clean entire area of any fluid residue upon completion of installation, and replace any and all plants and sod damaged, discolored or stained by drilling fluids.

## **III. EQUIPMENT REQUIREMENTS**

### **III.1. GENERAL**

The directional drilling equipment shall consist of a directional drilling rig of sufficient capacity to perform the bore and pullback the pipe, a drilling fluid mixing, delivery and recovery system of sufficient capacity to successfully complete the drill, a drilling fluid recycling system to remove solids from the drilling fluid so that the fluid can be re-used, a guidance system to accurately guide boring operations, a vacuum truck of sufficient capacity to handle the drilling fluid volume, trained and competent personnel to operate the system. All equipment shall be in good, safety operating condition with sufficient supplies, materials and spare parts on hand to maintain the system in good working order for the duration of this project.

### **III.2. DRILLING SYSTEM**

#### **III.2.1. DRILLING RIG**

The directional drilling machine shall consist of a power system to rotate, push and pull hollow drill pipe into the ground at a variable angle while delivering a pressurized fluid mixture to a guidable drill (bore) head. The power system shall be self-contained with sufficient pressure and volume to power drilling operations. Hydraulic system shall be free of leaks. Rig shall have a system to monitor and record maximum pull-back pressure during pull-back operations. The rig shall be

# ***JEA Water and Wastewater Standards***

## ***750 Small Pipe Horizontal Directional Drilling (12" or less)***

grounded during drilling and pull- back operations. There shall be a system to detect electrical current from the drilling string and an audible alarm which automatically sounds when an electrical current is detected.

### **III.2.2. DRILL HEAD**

The drill head shall be steerable by changing its rotation and shall provide the necessary cutting surfaces and drilling fluid jets.

### **III.2.3. MUD MOTORS (IF REQUIRED)**

Mud motors shall be of adequate power to turn the required drilling tools.

### **III.2.4. DRILL PIPE**

Shall be constructed of high quality 4130 seamless tubing, grade D or better.

## **III.3. GUIDANCE SYSTEM**

### **III.3.1. MAGNETIC GUIDANCE SYSTEM**

Magnetic Guidance System (MGS), wireline, wireless, wire line with surface grid verification or gyroscopic shall provide real time electronic data to the inspector on request. All daily data and project data shall be displayed on the "As Built". If deemed necessary, JEA shall at the contractor's expense request a third party to verify the drill path profile and location of the installed line to JEA satisfaction. The guidance system shall be capable of tracking a depth of 40 feet or 20 feet below design bore path whichever is greater and in any soil condition, including hard rock. It shall enable the driller to guide the drill head by providing immediate information on the tool face, azimuth (horizontal direction), and inclination (vertical direction) The guidance system shall be accurate to +/-2% of the vertical depth of the borehole at sensing position at depths up to one hundred feet and accurate within 1.5 meters horizontally. The Guidance System shall be of a proven type and shall be operated by personnel trained and experienced with this system. The Operator shall be aware of any magnetic anomalies on the surface of the drill path and shall consider such influences in the operation of the guidance system if using a magnetic system.

### **III.3.2. BORE TRACKING AND MONITORING**

At all times during the pilot bore the Contractor shall provide and maintain a bore tracking system that is capable of accurately locating the position of the drill head in the x, y, and z axes. The Contractor shall record these data at least once per drill pipe length or every twenty-five (25) feet, whichever is most frequent.

#### **III.3.2.1. Downhole And Surface Grid Tracking System**

Contractor shall monitor and record x, y, and z coordinates relative to an established surface survey bench mark. The data shall be continuously monitored and recorded at least once per drill pipe-length or at twenty-five (25) feet, whichever is more frequent.

#### **III.3.2.2. Deviations from Bore Path**

Deviations between the recorded and design bore path shall be calculated and reported on the daily log. If the deviations exceed plus or minus 5 feet (horizontal or vertical deviation) from the design path, such occurrences shall be reported immediately to JEA. The Contractor shall undertake all necessary measures to correct deviations and return to design line and grade.

# ***JEA Water and Wastewater Standards***

## ***750 Small Pipe Horizontal Directional Drilling (12" or less)***

### **III.4. DRILLING FLUID (MUD) SYSTEM**

#### **III.4.1. MIXING SYSTEM**

A self-contained, closed, drilling fluid mixing system shall be of sufficient size to mix and deliver drilling fluid. Mixing system shall continually agitate the drilling fluid during operations.

#### **III.4.2. DRILLING FLUIDS**

Drilling fluid shall be composed of clean water, appropriate additives and clay. Water shall be from an authorized source with a minimum pH of 6.0. Water of a lower pH or with excessive calcium shall be treated with the appropriate amount of sodium carbonate or equal. The water and additives shall be mixed thoroughly and be absent of any clumps or clods. No potentially hazardous material may be used in drilling fluid.

#### **III.4.3. DELIVERY SYSTEM**

The delivery system shall have filters in-line to prevent solids from being pumped into the drill pipe. Connections between the pump and drill pipe shall be relatively leak-free. Used drilling fluid and drilling fluid spilled during drilling operations shall be contained and conveyed to the drilling fluid recycling system. A berm, minimum of 12" high, shall be maintained around drill rigs, drilling fluid mixing system, entry and exit pits and drilling fluid cycling system to prevent spills into the surrounding environment. Pumps and or vacuum truck(s) of sufficient size shall be in place to convey excess drilling fluid from containment areas to storage and recycling facilities.

#### **III.4.4. DRILLING FLUID VISCOSITY**

In the event that inadvertent returns or returns loss of drilling fluid occurs during pilot hole drilling operations, Contractor shall cease drilling, wait at least 30 minutes, inject a quantity of drilling fluid with a viscosity exceeding 120 seconds as measured by a Marsh funnel and then wait another 30 minutes. If mud fracture or returns loss continues, Contractor shall cease operations and notify JEA Representative. JEA Representative and Contractor shall discuss additional options and work will then proceed accordingly.

#### **III.4.5. DRILLING FLUID PRESSURES AND FLOW RATES**

Drilling fluid pressures and flow rates shall be continuously monitored and recorded by the Contractor. The pressures shall be monitored at the pump. These measurements shall be made during pilot bore drilling, reaming, and pullback operations.

#### **III.4.6. DRILLING FLUID RECYCLING SYSTEM**

The drilling fluid recycling system shall separate sand, dirt and other solids from the drilling fluid to render the drilling fluid re-usable. Spoils separated from the drilling fluid will be stockpiled for later use or disposal.

#### **III.4.7. CONTROL OF DRILLING FLUIDS**

The Contractor shall follow all requirements of the Frac-Out and Surface Spill Contingency Plan as submitted and approved and shall control operational pressures, drilling mud weights, drilling speeds, and any other operational factors required to avoid hydrofracture fluid losses to formations, and control drilling fluid spillage. This includes any spillages or returns at entry and exit locations or at any intermediate point. All inadvertent returns or spills shall be promptly contained and cleaned up. The Contractor shall maintain on-site mobile spoil removal equipment during all drilling, pre-reaming, reaming and pullback operations and shall be capable of quickly removing

# ***JEA Water and Wastewater Standards***

## ***750 Small Pipe Horizontal Directional Drilling (12" or less)***

spoils. The Contractor shall immediately notify JEA of any inadvertent returns or spills and immediately contain and clean up the return or spill.

### **III.5. OTHER EQUIPMENT**

#### **III.5.1. PIPE ROLLERS**

Pipe rollers, if utilized, shall be of sufficient size to fully support the weight of the pipe while being hydro-tested and during pull-back operations. Sufficient number of rollers shall be used to prevent excess sagging of pipe.

#### **III.5.2. PIPE RAMMERS**

Hydraulic or pneumatic pipe rammers may only be used if necessary and with the authorization of JEA Representative.

#### **III.5.3. OTHER DEVICES**

Other devices or utility placement systems for providing horizontal thrust other than those defined above in the preceding sections shall not be used unless approved by the JEA Representative prior to commencement of the work. Consideration for approval will be made on an individual basis for each specified location. The proposed device or system will be evaluated prior to approval or rejection on its potential ability to complete the utility placement satisfactorily without undue stoppage and to maintain line and grade within the tolerances prescribed by the particular conditions of the projects.

#### **III.5.4. DATA LOGGER**

A data logger shall be used to record and document all butt weld fusion process. The data logger shall be of rugged, handheld computer as the recording device connected to a data collection device. The data collection device shall record the heater temperature and fusion pressure profile over time. All data shall be recorded and transmitted to the handheld computer where the joint report will be stored, viewed, printed, or transferred to a desk top computer for archiving. The operator associated with the fusion process shall utilize the data logger report as one means to confirm a complete and proper weld. This data shall be made immediately available to the JEA representative, upon request, unless approved otherwise by JEA, a written or downloader report for each fusion weld process shall be required and submitted to the JEA representative within ten working days after the fusion weld process for review and approval. If a potential defect fusion weld is suspected by JEA or the contractor, the work shall stop and a mutually acceptable (between the contractor and JEA) corrective action plan shall be executed. Equipment shall be JEA Standards approved

### **IV. DRILLING PROCEDURES**

#### **IV.1. DRILL PATH**

Prior to drilling Contractor shall utilize all verified locate information to determine drill pathway. Marked up drawings (see Site Preparation paragraph) shall be on site at all times, and referred to during the drill operation.

#### **IV.2. GUIDANCE SYSTEM**

Contractor shall provide and maintain instrumentation necessary to accurately locate the pilot hole (both horizontal and vertical displacements), measure pilot string torsional and axial and measure drilling fluid

# *JEA Water and Wastewater Standards*

## *750 Small Pipe Horizontal Directional Drilling (12" or less)*

discharge rate and pressure. The JEA Representative shall have access to instrumentation and readings at all times during operation.

### **IV.3. PILOT HOLE**

The pilot hole shall be drilled along the path shown on the plans and profile drawings or as directed by the JEA Representative in the field. Unless approved otherwise by JEA, the pilot-hole tolerances shall be as follows:

#### **IV.3.1. ELEVATION**

As shown on the plans.

#### **IV.3.2. ALIGNMENT**

Five feet inside of right-of-way or easement boundary.

#### **IV.3.3. CURVE RADIUS**

The pilot hole radius shall be no less than 80% of the maximum bending radius as recommended by the pipe manufacturer of the pipe being installed. In no case shall the bending radius be less than 30 pipe diameters, unless approved otherwise by JEA.

#### **IV.3.4. ENTRY POINT LOCATION**

The exact pilot hole entry point shall be within  $\pm 5$  feet of the location shown on the drawing or as directed by the JEA Representative in the field.

#### **IV.3.5. EXIT POINT LOCATION**

The exit point location shall be within  $\pm 5$  feet of the location shown on the drawing or as directed by the JEA Representative in the field.

#### **IV.3.6. LIMITATIONS ON DEPTH**

If not noted on the plans, 6" HDPE pipe and smaller shall be installed with a depth of 3 to 5 feet and 8" HDPE pipe thru 12" pipe shall be installed with a depth of 3 to 6 feet unless it is required to install the pipe deeper due to utility conflicts. HDPE pipe larger than 12" shall be specifically designed by the engineer and approved by JEA. Where utilities cross under DOT roads, the depth of cover shall comply with applicable DOT permit.

### **IV.4. WATER MAIN AND NON-WATER MAIN SEPARATION REQUIREMENTS**

The minimum separation requirements between HDPE water main and a non-water main shall be as outlined in specification Chapter III. 1. - Section 350 and Detail Nos. W-10 and W-11.

### **IV.5. PULL BACK**

After successfully reaming bore hole to the required diameter, Contractor will pull the pipe through the bore hole. In front of the pipe will be a swivel and reamer to compact bore hole walls. Once pull-back operations have commenced, operations must continue without interruption until pipe is completely pulled into bore hole. During pull-back operations Contractor will not apply more than the maximum safe pipe pull pressure at any time. Maximum allowable tensile force imposed on the pull section shall be equal to 80% of the pipe manufacturer's safety pull (or tensile) strength.

## *JEA Water and Wastewater Standards*

### *750 Small Pipe Horizontal Directional Drilling (12" or less)*

- IV.5.1. Torsional stress shall be minimized by using a swivel to connect a pull section to the reaming assembly.
- IV.5.2. The pullback section of the pipeline shall be supported during pullback operations so that it moves freely and the pipe is not damaged.
- IV.5.3. External pressure shall be minimized during installation of the pullback section in the reamed hole. Damaged pipe resulting from external pressure shall be replaced at no cost to the JEA.
- IV.5.4. Buoyancy modification shall be at the discretion of the Contractor and shall be approved by the JEA Representative. The Contractor shall be responsible for any damage to the pull section resulting from such modifications.
- IV.5.5. In the event that pipe becomes stuck, Contractor will cease pulling operations to allow any potential hydro-lock to subside and will commence pulling operations. If pipe remains stuck, Contractor will notify JEA Representative. JEA Representative and Contractor will discuss options and then work will proceed accordingly.

#### **IV.6. PIPE ASSEMBLY**

Pipe shall be welded/fused together in one length, if space permits. Pipe shall have no more than three (3) welds per 20 foot section. Pipe may be placed on pipe rollers before pulling into bore hole to minimize damage to the pipe. It is critical that all original oxidized pipe surface be removed in order for fusion to take place. The scraping process requires that approximately .10" of the outer "skin" be removed in order to penetrate the oxidation and contamination barrier. Oxidized pipe surface simply will not bond.

##### **IV.6.1. DAMAGED PIPE**

Cuts or gouges that reduce the wall thickness by more than 10% is not acceptable and must be cut out and discarded.

##### **IV.6.2. BUTT FUSION LOG**

Each butt fusion shall be recorded and logged by an electronic monitoring device affixed to the fusion machine. Joint data shall be submitted as part of the As-Recorded information, in accordance with this specification.

##### **IV.6.3. BUTT FUSION TESTING**

When requested by a JEA inspector, butt fusion testing will be performed. The test fusion shall be allowed to cool completely, and then fusion test coupons shall be cut out. The test shall utilize test coupons (conducted in accordance with manufactures recommendations).

##### **IV.6.4. MECHANICAL JOINING**

Polyethylene pipe and fittings may be joined together or to the materials by means of flanged connections mechanical couplings designed for joining polyethylene pipe or for joining polyethylene pipe to another material. Mechanical couplings shall be fully pressure rated and fully thrust restrained such that when installed in accordance with manufacturer's recommendations, a longitudinal load applied to the mechanical coupling will cause the pipe to yield before the mechanical coupling disjoins. External joint restraints shall not be used in lieu of fully restrained mechanical couplings.



# ***JEA Water and Wastewater Standards***

## ***750 Small Pipe Horizontal Directional Drilling (12" or less)***

### **IV.7. GENERAL REQUIREMENTS FOR OPEN-CUT CONSTRUCTION:**

#### **IV.7.1. MATERIALS**

Mains shall be constructed of the materials specified and as shown on the drawings.

#### **IV.7.2. HANDLING**

Pipe and fittings shall be carefully handled to avoid damage, and if feasible, while they are suspended over the trench before lowering, they shall be inspected for defects and to detect cracks. Defective, damaged or unsound pipe or fittings shall be rejected.

#### **IV.7.3. FILL**

Each section of the pipe shall rest upon the pipe bed for the full length of its barrel. Any pipe which has its grade or joint disturbed after laying shall be taken up and re-laid. Only suitable soils (no heavy clay) shall be utilized in the backfill operation up to 12 inches above the pipe.

#### **IV.7.4. CLEAN PIPE PRECAUTIONS**

All precautions shall be taken to prevent sand or other foreign material from entering the pipe during installation. If necessary, a heavy, tightly woven canvas bag of suitable size shall be placed over each end of the pipe before lowering into the trench and left there until the connection is made to the adjacent pipe. Any time the pipe installation is not in progress, the open ends of pipe shall be closed by a watertight plug or other method approved by the Engineer. Plugs shall remain in pipe ends until all water is removed from the trench. Any sand or foreign material that enters the pipe shall be removed from the pipe immediately.

#### **IV.7.5. STANDING WATER**

No pipe shall be installed when trench conditions (standing water, excess mud, etc.) or the weather (rain, etc.) is unsuitable for such work, except by permission of the Engineer. Any section of pipe already laid which is found to be defective or damaged shall be replaced with new pipe.

#### **IV.7.6. UTILITY LOCATES**

The contractor shall coordinate utility locates with Sunshine State One-Call of Florida, Inc. (# 811), at a minimum.

#### **IV.7.7. COVER AND DEPTH**

Cover for pipe under pavement shall be measured from the finished grade. Any reduction in pipe cover will require approval from JEA and the Engineer. Greater depths will be permitted where required to miss obstructions only. Lines shall be located as shown on the drawings. The Contractor shall investigate well in advance of pipe laying any conflicts which may require readjustments in planned locations and advise the Engineer of the results of these investigations so that the Engineer may give instructions as to the modifications required.

#### **IV.7.8. JEA STANDARDS**

Refer to Section 408 for over excavation, backfill and compaction requirements.

### **IV.8. AIR RELEASE VALVES**

Provide air release valve for all wastewater force main installations as indicated on drawings utilizing all stainless steel threaded outlet tapping sleeve.

# *JEA Water and Wastewater Standards*

## *750 Small Pipe Horizontal Directional Drilling (12" or less)*

### V. SWABBING

The purpose of swabbing a new pipeline is to conserve water while thoroughly cleaning the pipeline of all foreign material, sand, gravel, construction debris and other items not found in a properly cleaned system. Prior to pressure testing of a new pipeline swabbing shall be utilized for each project. Swabbing details, Chapter VIII, Plates W-45, W-45A, W-45B, W-45C and W-45D.

- V.1.1. New water, wastewater force, and reclaim mains greater than 12" I.D. (with exceptions as deemed necessary by JEA) shall be hydraulically cleaned with a polypropylene swabbing device to remove dirt, sand and debris from main.
- V.1.2. If swabbing access and egress points are not provided in the design drawings, it will be the responsibility of the CONTRACTOR to provide temporary access and egress points for the cleaning, as required.
- V.1.3. Passage of cleaning poly swabs through the system shall be constantly monitored, controlled and all poly swabs entered into the system shall be individually marked and identified so that the exiting of the poly swabs from the system can be confirmed.
- V.1.4. Cleaning of the system shall be done in conjunction with, and prior to, the initial filling of the system for hydrostatic testing.
- V.1.5. The contractor shall insert flexible polyurethane foam swabs (two pounds per cubic foot density) complete with rear polyurethane drive seal, into the first section of pipe. The swabs shall remain there until the pipeline construction is completed. A JEA representative shall be present for the swabbing process including swab insertion and retrieval.
- V.1.6. The line to be cleaned shall only be connected to the existing distribution system at a single connection point.
- V.1.7. Locate and open all new in-line valves beyond the point of connection on the pipeline to be cleaned during the swabbing operation.
- V.1.8. At the receiver or exit point for the poly swab, the CONTRACTOR is responsible for creating a safe environment for collection of debris, water and the swab. Considerations shall be made for protecting surrounding personnel and property and safe retrieval of the swab.
- V.1.9. Only with JEA personnel on-site shall the supply valve from the existing distribution system be operated. Cleaning and flushing shall be accomplished by propelling the swab down the pipeline to the exit point with potable water. Flushing shall continue until the water is completely clear and swab(s) is/are retrieved.
- V.1.10. Re-apply a series of individual swabs in varying diameters and/or densities as required, to attain proper cleanliness of pipeline.
- V.1.11. Swabbing speed shall range between two and five feet per second.
- V.1.12. After the swabbing process, pressure testing and disinfection of the pipe shall be completed in accordance with this manual.

# *JEA Water and Wastewater Standards*

## *750 Small Pipe Horizontal Directional Drilling (12" or less)*

### VI. TESTING

#### VI.1. DISINFECTION TESTS:

- VI.1.1. All water pipe and fittings shall be thoroughly disinfected prior to being placed in service. Disinfection shall follow the applicable provisions of the procedure established for the disinfection of water mains as set forth in AWWA - Standard C651 entitled "AWWA Standard for Disinfecting Water Mains" and shall be in accordance with Chapter III. 1. - Section 350. Bacteriological testing on the water main shall be scheduled and completed by JEA. JEA will collect the water samples and be responsible for completing the water analysis (lab testing).
- VI.1.2. Temporary blow-offs shall be installed for the purpose of cleaning the water main. Temporary blow-offs shall be removed and plugged after the main is cleared. The JEA Representative shall be present prior to and during the operation of blow-offs. The main shall be flushed prior to disinfection.
- VI.1.3. The new water main shall be connected to the existing water main at one point only for flushing purposes (no looping). The new main MUST have a blow off on the end as required previously. After the new main is thoroughly flushed, the open end shall be sealed and restrained and the main shall be thoroughly disinfected. Anytime the new line is reopened (to repair defective joints or pipe, defective fitting or valve) the complete disinfection process shall be repeated. Once bacteriological clearance has been received from the regulatory authority, the new main may be pressure tested.

#### VI.2. PRESSURE AND LEAKAGE TESTS:

- VI.2.1. Contractor shall test pipelines installed under this Contract in accordance with these specifications prior to acceptance of the pipeline by the JEA. All field tests shall be made in the presence of the JEA Representative. Except as otherwise directed, all pipelines shall be tested. Unless approved otherwise by JEA, all fusible or butt weld joints shall be tested, including MJ adapter fittings associated with the new construction. All piping to operate under liquid pressure shall be tested in sections of approved length. The pressure testing of an HDPE line section shall be tested separately from the PVC and DIP line sections. Where impractical, the HDPE test section shall include only a minimum amount of PVC and ductile iron pipe within the test section. If at all possible, the PVC and D.I.P. test sections shall be left exposed during the pressure test for visual leakage observation. For these tests, the Contractor shall furnish clean water, suitable temporary testing plugs or caps, and other necessary equipment, and all labor required. If the Contractor chooses to pressure test against an existing JEA water main/valve, the new water main must be disinfected prior to connection to the JEA line. The JEA will not be responsible for failure of the pressure test due to the existing valve leaking. JEA may elect to furnish suitable pressure gauges for these tests. If not, the contractor will furnish suitable pressure gauges, calibrated by an approved testing laboratory, which increments no greater than 2 psi. Gauges used shall be of such size that pressures tested will not register less than 10% or more than 90% of the gauge capacity. All valved sections shall be hydrostatic tested to insure sealing (leak allowance) of all line valves. All HDD over 100 LF shall be air pressure tested (above ground) @ 5 PSI for a period of 15 minutes, prior to insertion. There shall be no pressure loss allowed.
- VI.2.2. Unless it has already been done, the section to pipe to be tested shall be filled with potable water and air shall be expelled from the pipe. Reclaimed water may be utilized for filling new reclaimed water or wastewater force main installations. If blow offs or other outlets are not available at high

# *JEA Water and Wastewater Standards*

## *750 Small Pipe Horizontal Directional Drilling (12" or less)*

points for releasing air, the Contractor shall provide 1-inch (minimum taps and blow-off valves (at the 12:00 position), as necessary. The cost of constructing blow-off valves and plugging them, after a successful pressure test, shall be included in the unit price bid amount for the HDPE pipe.

VI.2.3. Hydrostatic testing shall consist of a 150 psig test pressures, based on the elevation of the highest point of the line or section under tests. Pressure shall be applied by means of a pump connected to the pipe in a manner satisfactory to the JEA Representative. The pump, pipe connection and all necessary apparatus shall be furnished by the Contractor and shall be subject to the approval of the JEA Representative.

VI.2.4. Maximum duration for pressure test, including initial and final phase of the test, shall not exceed eight (8) hours. If the test is not completed due to leakage, equipment failure, etc., depressurize the test section, and then allow it to "relax" for at least eight (8) hours before bringing the test section up to test pressure again.

VI.2.4.1. Initial Phase of Pressure Testing

First, all air must be removed from the test section. The pressure test shall be completed after the line is backfilled. If possible, all flanged or mechanical joint valves and fittings shall be left exposed for visual leak inspection. If possible all PVC and D.I.P. test sections shall be left exposed for visual leak inspection. Initially, the pressure within the test section should be raised to approximately 160 psi and then allowed to be idle (no additional make-up water/pressure to be injected), for approximately 3 hours. During this 3-hour period, the test section shall be allowed to stabilize and come to an equilibrium stage. No additional make-up water/pressure shall be applied to the test section during this 3-hour stabilization period unless the line pressure drops below 140 psi. In this case, make-up water/pressure shall only be applied to the test section to maintain a minimum of 140 psi (during the 3-hour stabilization period).

VI.2.4.2. Final Phase of Pressure Testing

The final phase of the pressure test shall involve applying make-up water/pressure to achieve an "initial test pressure" of 150 psi (minimum)/155 psi (maximum). The test section is then allowed to be idle (no make-up water/pressure is added) for a period of 2 hours. After this 2-hour period, make-up water/pressure is applied and measured to re-establish the "initial test pressure". The quantity of water utilized to re-pump the line shall be measured and compared to the allowable quantities as determined by the table below. If the actual make-up water quantity is equal or less than the allowable amount, the pressure test passes. If the actual make-up water quantities are greater than the allowable amount, the pressure test fails (see enclosed JEA test form).

<b>Table 1: Allowable Make Up Amount</b>	
<b>Nominal Pipe Size (inches)</b>	<b>Make-up Water Allowance (Gallons/Linear feet of Pipe) 2-hour test</b>
6	0.0030
8	0.0050
10	0.0065

## *JEA Water and Wastewater Standards*

### *750 Small Pipe Horizontal Directional Drilling (12" or less)*

12	0.0115
14	0.0140
16	0.0165
18	0.0215
20	0.0275
22	0.0350
24	0.0440
26	0.0500
28	0.0555
30	0.0635
32	0.0715
34	0.0810
36	0.0900
42	0.1155
48	0.1350
54	0.1570

- VI.2.5. In the event a section fails to pass the tests, the Contractor shall do everything necessary to locate, uncover (even to the extent of uncovering the entire section), and replace the defective pipe, valve, fitting or joint. Visible leaks shall be corrected regardless of total leakage. Lines which fail to meet these tests shall be retested as necessary until test requirements are complied with. All testing shall be performed at the Contractor's expense.
- VI.2.6. If, in the judgment of JEA, it is impracticable to follow the foregoing procedures exactly for any reason, modifications in the procedure shall be made with approval; but, in any event, the Contractor shall be responsible for the ultimate tightness of the piping within the above requirement. Re-disinfection shall be required if the line is de-pressurized for repairs prior to tying.

#### **VII. LOCATE WIRE**

Two locate wires shall be provided on all installations. For HDD projects, locate wire shall be 8 AWG high strength copper-clad carbon steel with 45 mils (min) insulation. For open-cut projects, the locate wire construction and testing shall meet the locate wire requirements, as specified in Chapter III. 1. - Section 350 and Chapter IV.3.-Section 429 [12 gauge, single strand, UF rated, copper-clad steel wire with 30 mil (minimum) insulation]. The external color shall be either blue for water, green for wastewater, purple for reuse, or black for raw water. Locate wire shall be brought to grade within a valve box or locate station box at all "entry point locations" and all "exit point locations". For HDD projects, there is no maximum length or interval between locate wire stations. The testing and report requirements within Chapter III. 1. - Section 350 and Chapter IV.3.-Section 429 shall be required except as modified herein. If both locate wires break or is not continuous (from end to end), the contractor shall, at the contractor's expense, provide soft-digs for the portions of the main with 12-feet or less cover (every 25 LF along main) to confirm as-built data. This soft-dig data shall be recorded on the as-built record drawings as specified here-in.

*JEA Water and Wastewater Standards  
750 Small Pipe Horizontal Directional Drilling (12" or less)*

**VIII.COMPLIANCE**

Failure to comply with the JEA Standards herein or failure to verify "As Builts" as required shall result in; the Contractor, Engineer, and Surveyor will be unable to bid future JEA projects and removed from the JEA approved contractor's list for a minimum of twelve months.

**IX. INSPECTION CHECKLISTS AND REPORTS**

# JEA Water and Wastewater Standards

## 750 Small Pipe Horizontal Directional Drilling (12" or less)

### IX.1. PRESSURE AND LEAKAGE TEST: HDPE PIPE

Project Name: \_\_\_\_\_

Test Section: \_\_\_\_\_

Availability Number: \_\_\_\_\_ Project Number: \_\_\_\_\_ Date/Time: \_\_\_\_\_

Date/Time Start: \_\_\_\_\_ Date/Time Finish: \_\_\_\_\_

STA/Offset Start: \_\_\_\_\_ STA/Offset Finish: \_\_\_\_\_

Other Test Phase Attendees: \_\_\_\_\_

\_\_\_\_\_

\_\_\_\_\_

Service:  Potable Water  
 Reclaimed Water  
 Wastewater

#### Line Pressure Test:

Start: \_\_\_\_\_ PSI Minimum of 150 PSI or 2 x the operating pressure

End: \_\_\_\_\_ PSI

PSI Difference: \_\_\_\_\_ PSI If greater than 5 psi, the test fails

Line Pressure Test Results  Pass  Fail

#### Line Leakage Test:

TYPE OF HDPE PIPE (DR RATING) (1)	DIAMETER OF PIPE (INCHES) (2)	LINEAR FEET (3)	2-HOUR TEST FACTOR (See Table Below *) (4)	TOTAL ALLOWABLE LEAKAGE (3x4) (5)
Total Allowable Leakage Amount (Gallons)				

## JEA Water and Wastewater Standards 750 Small Pipe Horizontal Directional Drilling (12" or less)

JEA 2-HOUR TEST FACTORS			
*NOMINAL PIPE SIZE (inches) – ALLOWABLE LEAKAGE AMOUNT (Gallons/Linear Feet of Pipe)			
4" – 0.0020	6" – 0.0030	8" – 0.0050	10" – 0.0065
18" – 0.0215	20" – 0.0275	22" – 0.0350	24" – 0.0440
32" – 0.0715	34" – 0.0810	36" – 0.0900	42" – 0.1155
4" – 0.0020	6" – 0.0030	8" – 0.0050	10" – 0.0065
18" – 0.0215	20" – 0.0275	22" – 0.0350	24" – 0.0440
32" – 0.0715	34" – 0.0810	36" – 0.0900	42" – 0.1155

Allowable Leakage Amount \_\_\_\_\_ GAL      \_\_\_\_\_ Oz. (32 oz per qt, 128 oz per gal)

Actual Leakage Amount \_\_\_\_\_ GAL      \_\_\_\_\_ Oz.

Line Leakage Test Results     Pass     Fail

The above is based on the average pressure test of 150 PSI, 2 hour test period. If the actual leakage amount is equal or less than the allowable leakage amount, the leakage test is acceptable.

Comments:

---



---



---

Contractor Representative:

---

Signature & Printed Name

JEA Inspector:

---

Signature & Printed Name

JEA O&M representative:

---

Signature & Printed Name



*Blank Page*

## **755 - LARGE PIPE HORIZONTAL DIRECTIONAL DRILLING (PIPE LARGER THEN 12 INCHES)**

### **I. GENERAL REQUIREMENTS**

#### **I.1. SCOPE OF WORK**

The work specified in this section consists of furnishing and installing underground utilities using the horizontal directional drilling (HDD) method of installation for pipe larger than 12 inches inside diameter (ID), also commonly referred to as directional boring or guided horizontal boring. This work shall include all services, equipment, materials, and labor for the complete and proper installation, testing, restoration of underground utilities and environmental protection and restoration. If warranted by JEA, a dual horizontal directional drilling shall be required.

#### **I.2. QUALITY ASSURANCE**

The requirements set forth in this document specify a wide range of procedural precautions necessary to insure that the very basic, essential aspects of a proper directional bore installation are adequately controlled. Strict adherence shall be required under specifically covered conditions outlined in this specification or within any associated permit (i.e.: DEP, DOT, Etc.). Adherence to the specifications contained herein, or the JEA Representative's approval on any aspect of any directional bore operation covered by this specification, shall in no way relieve the Contractor of their ultimate responsibility for the satisfactory completion of the work authorized under the Contract. The HDD contractor shall be responsible for the repair of all damage to private and/or public property (at no expense to JEA). Repair work shall meet all local and state rules and requirements.

#### **I.3. QUALIFICATIONS**

The work specified in this Section requires significant previous experience and expertise in similar work to avoid negative impacts to public safety and the environment. Therefore, the Contractor performing the work shall be qualified, in JEA's judgment, to complete the horizontal directional drilling work specified herein. In order to qualify to perform work specified in this Section the Contractor must provide evidence satisfactory to JEA, including the following:

I.3.1. Contractor to have successfully self-performed at least (5) horizontal directional drilling projects to install product pipe of a similar nominal diameter and length to the proposed project within the past two years. JEA shall have sole authority to determine the adequacy of representative projects.

I.3.2. The Contractor's project manager, superintendent, drill operator, and guidance system operator assigned to horizontal directional drilling shall be experienced in work of this nature and shall have successfully completed similar projects using horizontal directional drilling. The Contractor shall submit substantiating evidence of qualifications, in accordance with the provisions of this Section, with the bid submittal documents. Failure to submit the required documentation will cause the Contractor to be declared nonresponsive. If the Contractor elects to employ a specialist subcontractor(s) to perform horizontal directional drilling, the Contractor shall obtain and submit qualification documents for the subcontractor(s). Subcontractor(s) shall be held to the same requirements as those for the Contractor described herein.

I.3.3. All drilling, drill guidance, and pipe joining equipment operators shall be experienced in comparable horizontal directional drilling work, and shall have been fully trained in the use of the proposed

# ***JEA Water and Wastewater Standards***

## ***755 Large Pipe Horizontal Directional Drilling (larger than 12")***

equipment by an authorized representative of the equipment manufacturer(s) or their authorized training agents.

- I.3.4. All HDPE-fusion equipment operators shall be qualified to perform pipe joining using the means, methods and equipment employed by the contractor. Fusion equipment operators shall have current, formal training on all fusion equipment employed the project. Training received more than two years prior to operation of the fusion equipment shall not be considered current. The Contractor shall submit written certification of training provided by the fusion equipment manufacturer.

### **I.4. PROJECT SCHEDULE AND COOPERATION**

The project schedule shall be established on the basis of working a normal work schedule including five days per week, single shift, and eight hours per day or four days per week, single shift, ten hours per day. Unless approved otherwise by JEA normal or general items of work, such as bacteriological testing, leakage and pressure testing, density testing and final inspections, shall be scheduled during the normal work schedule. Due to operational and manpower limitations on the JEA systems, JEA will require the contractor to perform work outside of the normal work schedule. These operational and manpower limitations, including but not limited to, line filling and flushing operation, tie-in work, (cut-in work or other work) and other phases of the work which may impact the continued (non-interruptible) service to existing JEA customers. The contractor shall plan and anticipate the cost impact of these systems limitations and provide such work or services at no additional cost to JEA.

### **I.5. WARRANTY**

#### **I.5.1. CONTRACTOR WARRANTY**

I.5.1.1. The contractor shall supply to JEA a two (2) year unconditional warranty. The warranty shall include materials and installation and shall constitute complete replacement and delivery to the site of materials and installation of same to replace defective materials or defective workmanship with new materials/workmanship conforming to the specifications.

I.5.1.2. The contractor shall warrant to JEA that the methods used on the contract, where covered by patents or license agreements, are furnished in accordance with such agreements and that the prices included herein cover all applicable royalties and fees in accordance with such license agreements. The contractor shall defend, indemnify, and hold JEA harmless from and against any and all costs, loss, damage or expense arising out of, or in any way connected with, any claim of infringement of patent, trademark, or violation of license agreement.

#### **I.5.2. PIPE WARRANTY**

The pipe manufacturer shall provide a warranty to the contractor that the pipe conforms to these specifications and that the pipe shall be free from defects in materials and workmanship for a period of two (2) years from the date of substantial completion of the installation. The manufacturer's warranty shall be in a form acceptable to and for the benefit of JEA and shall be submitted by the contractor as a condition of final payment. The manufacturer's warranty to the contractor shall in no way relieve the contractor from its unconditional warranty to JEA.

### **I.6. REFERENCED STANDARDS**

# *JEA Water and Wastewater Standards*

## *755 Large Pipe Horizontal Directional Drilling (larger than 12")*

I.6.1. The work shall conform to applicable provisions of the JEA Water and Wastewater Standards, and the following standards, latest editions, except as modified herein.

I.6.2. **AMERICAN WATER WORKS ASSOCIATION (AWWA) STANDARDS:**

- AWWA C906: Polyethylene (PE) Pressure Pipe and Fittings, 4 inch through 63 inch, for Water Distribution American Society for Testing and Materials (ASTM) Standards.
- ASTM D638: Standard Test Method for Tensile Properties of Plastics.
- ASTM D2122: Standard Method of Determining Dimensions of Thermoplastics Pipe and Fittings.
- ASTM D2683: Standard Specification for Socket-Type Polyethylene Fittings for Outside Diameter-Controlled Polyethylene Pipe and Tubing.
- ASTM D2837: Standard Test Method for Obtaining Hydrostatic Design Basis for Thermoplastic Pipe Materials.
- ASTM D3035: Standard Specification for Polyethylene (PE) Plastic Pipe (SDR-PR) Based on Controlled Outside Diameter.
- ASTM E3261: Standard Specification for Butt Heat Fusion Polyethylene Plastic Fittings for Polyethylene (PE) Plastic Pipe and Tubing.
- ASTM D3350: Standard Specification for Polyethylene Plastic Pipe and Fittings Materials.
- ASTM F1962: Standard Guide for polyethylene Pipe or Conduit Under Obstacles, including River Crossing.
- ASTM F412: Standard Terminology Relating to Plastic Piping Systems.
- ASTM F714: Standard Specification for Polyethylene (PE) Plastic Pipe (SDR-PR) Based on Outside Diameter.
- ASTM F2620: Standard Practice for Heat Fusion Joining of Polyethylene Pipe and Fittings.

I.7. **PERMITS**

The Contractor shall verify the existence of all permits before commencing any work on the project.

I.8. **SUBMITTALS (HDD PROJECTS ONLY)**

I.8.1. **CONTRACTOR QUALIFICATIONS**

I.8.1.1. The Contractor shall submit information demonstrating compliance with the Contractor and personnel qualification requirements of this Section. The Contractor shall provide the required qualifications submittals along with the bid.

I.8.1.2. The Contractor shall submit the following information for each referenced project:

- Name and general description of project.
- Name, position, address, and telephone number of contact for JEA.
- Contract start and completion date.
- Contract type and value.
- Length and diameter of completed bore(s).
- Diameter of completed bore(s).

# *JEA Water and Wastewater Standards*

## *755 Large Pipe Horizontal Directional Drilling (larger than 12")*

- Description of pipe(s).
- Type and manufacturer of drilling and installation equipment used.
- Ground conditions encountered.
- If the referenced project is not yet completed, the Contractor shall include:
- Anticipated completion date.
- Value of work completed to date and anticipated final contract value.

I.8.1.3. The Contractor shall submit the following personnel information:

- Names and resumes, including specific project experience, for the proposed project manager, superintendent, guidance operator, and drill operator, demonstrating that each meets the requirements of this Section.
- Names and qualifications, including specific project experience, for all proposed drilling, drill guidance, and pipe joining equipment operators, including evidence of training in the use of the proposed equipment by an authorized representative of the equipment manufacturer or their qualified agent.

### **I.8.2. WORK PLAN**

Prior to beginning work, the Contractor must submit to the JEA Representative a work plan detailing the procedure and schedule to be used to execute the project. Horizontal directional drilling shall not commence until the contractor has received written approval of all work plan submittals from JEA.

### **I.8.3. METHODS**

The Contractor shall provide complete descriptions of proposed plans, procedures, and personnel, as well as supporting calculations, for the following:

- I.8.3.1. Drilling operations, addressing: Procedures for pilot hole drilling and reaming. Procedures for tracking and controlling the drilling head location. Procedures for preparing as-builts.
- I.8.3.2. Drilling fluid management plan.
- I.8.3.3. Spoils handling and disposal plan.
- I.8.3.4. Pipe storage and handling, addressing: Means and methods for protecting pipe and ensuring temperature control in accordance with the Contractor's installation calculations.
- I.8.3.5. Pipeline assembly and installation, addressing: Procedures for pipe joining, pipeline pullback, and pullback monitoring.
- I.8.3.6. Prevention of inadvertent fluid losses and spills, and contingencies for rapid containment and cleanup, addressing: Measures to mitigate risk of inadvertent fluid returns to surface. Procedures for monitoring and controlling drilling fluid flows and pressures. Equipment, resources, and procedures for identifying, containing, and cleaning up fluid losses and spills.

# ***JEA Water and Wastewater Standards***

## ***755 Large Pipe Horizontal Directional Drilling (larger than 12")***

I.8.3.7. Quality control and testing procedures.

I.8.3.8. Safety plan.

### **I.8.4. SCHEDULE**

The Contractor shall provide a schedule for all horizontal directional drilling activities commencing with the site preparation and terminating on completion of testing and final acceptance of the installed pipe. The schedule shall address anticipated subsurface conditions and overall project requirements.

### **I.8.5. EQUIPMENT**

The Contractor shall provide the make, model, and technical specifications for each of the following:

- Horizontal directional drill rig
- Drilling system components
- Downhole drilling assembly and reaming equipment
- Downhole pressure sub
- Guidance and control system
- Pulling head
- Swivel
- Rollers
- Solids separation and drill fluid recirculation systems
- Pipe fusion equipment
- Pipe fusion data logger
- Pipe handling equipment
- Pigs and pigging equipment

The Contractor shall provide the following specific equipment information:

- Calibration certification for the pilot bore guidance and control system.
- Calibration certification for the heat fusion data logger.

### **I.8.6. SUPPLEMENTAL WORK PLAN REQUIREMENTS**

The Contractor shall provide the following additional work plan submittals within 30 days of receiving notice to proceed. The submission requirements for additional work plan submittals including number of copies and delivery of submittals shall follow the requirements outlined in the general requirements. Horizontal directional drilling shall not commence until the Contractor has received written approval of all supplemental work plan submittals.

I.8.6.1. The Contractor shall submit traffic control plans for entry and exit pit sites.

I.8.6.2. Plans for mitigating the potential for inadvertent drilling fluid losses to surface, and for rapidly identifying and cleaning up spills near the investigation borings located along the project alignment. Investigation boreholes along the alignment have been backfilled as reported in the Geotechnical Report. The Contractor's work plans shall address the risk that all investigation boreholes may contribute to the risk of drill fluid loss.

## ***JEA Water and Wastewater Standards***

### ***755 Large Pipe Horizontal Directional Drilling (larger than 12")***

- I.8.6.3. Contingency plan for rapidly identifying, locating, and containing any drilling fluid returns.
- I.8.6.4. The Contractor shall submit a contingency plan to address procedures to be employed in the event any of the listed items occur.
- Utility strike, obstruction, or inability to advance drill pipe.
  - Excessive deviation from proposed line and grade, as described within this Section.
  - Inability to move pipe through borehole during pullback.
  - Settlement or heave of roadways and structures within 50 feet of the alignment

#### **I.8.7. CALCULATIONS**

I.8.7.1. The Contractor shall submit final design calculations for JEA's review and approval within 90 days of receiving notice to proceed. Final design calculations shall support the Contractor's specific proposed means, methods, and products. The Contractor's final design calculations shall be prepared and sealed by a Licensed Professional Engineer registered to practice in the State of Florida, and retained by the Contractor. Horizontal directional drilling shall not commence until the Contractor has received written approval of all design calculation submittals from JEA. At a minimum, design calculations shall demonstrate that the proposed pipe, equipment, and means and methods comply with the requirements of this Section and have been designed based on the design bore path, and installation means and methods, for anticipated installation and handling, hydrostatic, earth, and live loads, installation temperature and site conditions. Design calculations shall address the considerations and guidelines presented in ASTM F1962.

- I.8.7.2. The Contractor shall supply copies of all other calculations required to support the required submittals for horizontal directional drilling. At a minimum, the following calculations should be included:
- Maximum allowable pipe loading limits.
  - Pullback load calculation based upon proposed drill path plan and profile.
  - Buoyancy effect calculations.
  - Effects of ballasting plan on pipe pullback forces.
  - Hydrofracture analysis. This should include a maximum annular pressure curve and the respective formation pressure versus depth based on the proposed drill plan and profile.
  - Confirmation that design parameters do not exceed predicted installation stresses including factors such as tensile load, buckling and deformation.

#### **I.8.8. SHOP DRAWING SUBMITTALS**

Actual catalog data, brochures and descriptive literature will not be required for items of standard usage which meet the requirements of the JEA Water and Wastewater Standards Manual. Any specialty item not shown in this manual will require a complete shop drawing submittal for any material which may, in the Engineer's opinion, not be in compliance with the JEA Water and Wastewater Standards.

# ***JEA Water and Wastewater Standards***

## ***755 Large Pipe Horizontal Directional Drilling (larger than 12")***

### **I.8.9. CONSTRUCTION RECORDS**

#### **I.8.9.1. DAILY REPORTS:**

The Contractor shall maintain daily activity reports throughout all horizontal directional drilling operations, including pipe installation. A sample daily report shall be submitted to JEA for approval prior to the commencement of drilling operations. Daily reports shall be submitted within 24 hours of completion, and shall include, for each drill rod added or withdrawn, or every 30 feet during drilling, pre-reaming, and pullback:

- Downhole tools and equipment in use.
- Description of ground conditions encountered.
- Description of drilling fluid.
- Drilling fluid pumping rate.
- Maximum and minimum downhole fluid pressures.
- Drilling head location - at least every 10 feet along the bore path.
- Drill stem torque.
- Details and perceived reasons for delays greater than one hour other than normal breaks and shift changes.
- Details of any unusual conditions or events.

#### **I.8.9.2. Production and As-Built Drawings**

The Contractor shall maintain at the construction site a complete set of field drawings for recording the as-built conditions. The Contractor shall plot as-built conditions on the field drawings, including the location in plan and elevation of the drill string, reaming head, and installed pipe, at the completion of each production shift. The Contractor shall compile and submit as-built data in accordance with JEA Water and Wastewater Standards Section 501. As-builts shall include all bores successful and failed.

#### **I.8.9.3. Testing and Quality Control and Assurance Documentation**

The Contractor shall maintain records for all testing and quality control and assurance procedures. The following records shall be provided to JEA or JEA's Representative on the day that information is acquired by the Contractor:

- Manufacturer's Field Reports.
- Test reports.
- Fusion reports. For each weld, provide an electronic and printed report of the downloaded information for each weld.

### **I.9. NOTIFICATIONS**

The JEA representative must be notified 48 hours (minimum) in advance of starting the drilling work. The Directional Bore shall not begin until the proper preparations (see work plan) for the operation have been completed.

### **I.10. SITE PREPARATION**



# ***JEA Water and Wastewater Standards***

## ***755 Large Pipe Horizontal Directional Drilling (larger than 12")***

- I.10.1. Prior to any alterations to work-site, Contractor shall photograph or video tape entire work area. One copy of which shall be given to JEA Representative and one copy to remain with Contractor for a period of two (2) years following the completion of the project.
- I.10.2. The Contractor shall coordinate utilities locates with Sunshine State One-Call of Florida, Inc., (#811 or web site [www.callsunshine.com](http://www.callsunshine.com)). Once the locate service has field marked all utilities, the Contractor shall verify each utility (including any service laterals, i.e. water, wastewater, cable, gas, electric, phone, etc.) and those within each paved area. Verification may be performed utilizing Ground Penetrating Radar, hand dig, or vacuum excavation. Prior to initiating drilling, the Contractor shall record on the drawings both the horizontal and vertical location of the utilities off of a predetermined baseline. The Contractor shall utilize the Ground Penetrating Radar over the projected bore path whether utilities are located in the horizontal drill pathway or not, in order to reduce the opportunity of conflicting with any unforeseen obstructions.
- I.10.3. Work site shall be graded and filled to provide a level working area. No alterations beyond what is required for operations are to be made. Contractor shall confine all activities to designated work areas.
- I.10.4. Following drilling operations, Contractor will de-mobilize equipment and restore the work-site to original condition. All excavations will be backfilled and compacted to 95% of original density (at a minimum).

### **I.11. ENVIRONMENTAL PROTECTION**

Contractor shall place silt fence between all drilling operations and any drainage, wetland, waterway or other area designated for such protection by contract documents, state, federal and local regulations. Contractor shall place hay bales, or approved protection, to limit intrusion upon project area. Additional environmental protection necessary to contain any hydraulic or drilling fluid spills shall be put in place, including berms, liners, turbidity curtains and other measures. Contractor shall adhere to all applicable environmental regulations including environmental condition stated in local, state and federal permits. Fuel may not be stored in bulk containers (greater than 25 gallons) within 200' of any water-body or wetland.

### **I.12. SAFETY**

Contractor shall adhere to all applicable state, federal and local safety regulations and all operations shall be conducted in a safe manner.

### **I.13. DOMESTIC WATER**

For the supply of domestic water during construction, the contractor shall utilize a JEA meter assembly (meter & backflow device) and pay for all water consumed except in the case where the new water main is connected directly into the active water system for line filling and flushing operation. Un-metered reclaimed water may be utilized for flushing and testing of new reclaimed water mains. Un-accountable domestic water quantities shall be minimized, where possible.

## **II. MATERIALS**

### **II.1. PIPE AND FITTINGS**

#### **II.1.1. HIGH DENSITY POLYETHYLENE (HDPE, PE) PIPE AND FITTINGS**

# ***JEA Water and Wastewater Standards***

## ***755 Large Pipe Horizontal Directional Drilling (larger than 12")***

Materials used for the manufacturer of polyethylene pipe and fittings shall be PE3608 or PE4710 high density polyethylene meeting cell classification 345464C per ASTM D3350; and meeting Type III, Class B or Class C, Category 5, Grade P34 per ASTM D1248; and shall be listed in the name of the pipe and fitting Manufacturer in PPI TR-4, Recommended Hydrostatic Strengths and Design Stresses for Thermoplastic Pipe and Fittings Compounds, with a standard grade rating of 1600 psi at 73°F per ASTM D-2837. The Manufacturer shall certify that the materials used to manufacture pipe and fittings meet these requirements. Refer to section XI, plates S-21, for dual drill 21A.

### **II.1.2. POLYETHYLENE PIPE**

HDPE Pipe shall conform to AWWA C906, DR-11, Ductile Iron Pipe (DIP) size and NSF 61 Standard. For pipe sizes 24-inch and larger, the HDPE may be IPS size, DR 11. Polyethylene pipe shall be manufactured in accordance with ASTM F714, Polyethylene (PE) Plastic Pipe (SDR-PR) Based on Controlled Outside Diameter and shall be so marked. Each production lot of pipe shall be tested for (from material or pipe) melt index, density, % carbon, dimensions and either quick burst or ring tensile strength (equipment permitting).

### **II.1.3. NOMINAL PIPE SIZES**

Nominal pipe sizes only are indicated on the drawings and bid form. Outside diameter of pipe is generally 1 to 2-inches greater than the nominal pipe diameter. The HDPE pipe size shall be selected (up-sized) to maintain the internal diameter relatively equal to ductile iron sizes.

## **II.2. SERVICE IDENTIFICATION**

Permanent identification of piping service shall be provided by co-extruding multiple equally spaced color stripes into the pipe outside surface or by solid colored pipe shell. The striping material shall be the same material as the pipe material except for color. The following colors shall be used to identify piping service (pressure service):

- Blue – potable water
- Green – wastewater or force main
- Purple – reclaimed water
- Black – raw water
- White – chilled water

## **II.3. BACK-UP RINGS AND FLANGE BOLTS**

Flange adapters shall be fitted with lap joint flanges pressure rated equal to or greater than the mating pipe. Convoluted style backup rings preferred over the flat stock rings. The lap joint flange bore shall be chamfered to provide clearance to the flange adapter radius. Flange bolts and nuts shall be Grade 2 or higher.

## **II.4. MANUFACTURER'S QUALITY CONTROL**

The pipe and fitting manufacturer shall have an established quality control program responsible for inspecting incoming and outgoing materials. Incoming polyethylene materials shall be inspected for density, melt flow rated, and contamination. The cell classification properties of the material shall be certified by the supplier, and verified by Manufacturer's Quality Control.

## **II.5. POLYETHYLENE MECHANICAL JOINT (MJ) ADAPTERS**

# ***JEA Water and Wastewater Standards***

## ***755 Large Pipe Horizontal Directional Drilling (larger than 12")***

Mechanical connections of HDPE pipe to Ductile Iron or PVC piping, mechanical joint fittings, or valves shall be through a fusible mechanical joint adapter with or without an integral, internal stainless steel insert. Mechanical joint adapter shall be of the same DR rating as the pipe. Note that PE flanged adapters may be utilized for pipe sizes 30 inches and larger.

### **II.6. DRILLING FLUIDS**

Drilling fluids shall be a bentonite slurry.

### **II.7. DELIVERY, STORAGE AND HANDLING OF MATERIALS**

II.7.1. Inspect materials delivered to the site for damage. All materials found during inspection or during the progress of work to have cracks, flaws, cracked linings, or other defects shall be rejected and removed from the job site without delay.

II.7.2. Unload and store opposite or near the place where the work will proceed with minimum handling. Store material under cover out of direct sun light. Do not store directly on the ground. Keep all materials free of dirt and debris.

II.7.3. Contractor is responsible for obtaining, transporting and sorting any fluids, including water, to the work site.

II.7.4. Disposal of fluids is the responsibility of the Contractor. Disposal of fluids shall be done in a manner that is in compliance with all permits and applicable federal, state, or local environmental regulations. The bentonite drilling slurry may be recycled for reuse in the hole opening operation, or shall be hauled by the Contractor to an approved location or landfill for proper disposal. Contractor shall thoroughly clean entire area of any fluid residue upon completion of installation, and replace any and all plants and sod damaged, discolored or stained by drilling fluids.

## **III. EQUIPMENT REQUIREMENTS**

### **III.1. GENERAL**

The directional drilling equipment shall consist of a directional drilling rig of sufficient capacity to perform the bore and pullback the pipe, a drilling fluid mixing, delivery and recovery system of sufficient capacity to successfully complete the drill, a drilling fluid recycling system to remove solids from the drilling fluid so that the fluid can be re-used, a guidance system to accurately guide boring operations, a vacuum truck of sufficient capacity to handle the drilling fluid volume, trained and competent personnel to operate the system. All equipment shall be in good, safety operating condition with sufficient supplies, materials and spare parts on hand to maintain the system in good working order for the duration of this project.

### **III.2. DRILLING SYSTEM**

#### **III.2.1. DRILLING RIG**

The directional drilling machine shall consist of a power system to rotate, push and pull hollow drill pipe into the ground at a variable angle while delivering a pressurized fluid mixture to a guidable drill (bore) head. The power system shall be self-contained with sufficient pressure and volume to power drilling operations. Hydraulic system shall be free of leaks. Rig shall have a system to monitor and record maximum pull-back pressure during pull-back operations. The rig shall be grounded during drilling and pull-back operations. There shall be a system to detect electrical

# ***JEA Water and Wastewater Standards***

## ***755 Large Pipe Horizontal Directional Drilling (larger than 12")***

current from the drilling string and an audible alarm which automatically sounds when an electrical current is detected.

### **III.2.2. DRILL HEAD**

The drill head shall be steerable and shall provide the necessary cutting surfaces and drilling fluid jets.

### **III.2.3. MUD MOTORS (IF REQUIRED)**

Mud motors shall be of adequate power to turn the required drilling tools.

### **III.2.4. DRILL PIPE**

Shall be constructed of high quality 4130 seamless tubing, grade D or better.

## **III.3. GUIDANCE SYSTEM**

### **III.3.1. MAGNETIC GUIDANCE SYSTEM**

Magnetic Guidance System (MGS) wireline, wireless or gyroscopic shall provide real time electronic data to the inspector on request. All daily data and project data shall be displayed on the "As Built". If deemed necessary, JEA shall at the contractor's expense request a third party to verify the drill path profile and location of the installed line to JEA satisfaction. The guidance system shall be capable of tracking at all depths up to forty feet (40') below the maximum proposed depth and in any soil condition, including hard rock. It shall enable the driller to guide the drill head by providing immediate information on the tool face, azimuth (horizontal direction), and inclination (vertical direction) The guidance system shall be accurate to +/-2% of the vertical depth of the borehole at sensing position at depths up to one hundred feet and accurate within 1.5 meters horizontally. The Guidance System shall be of a proven type and shall be operated by personnel trained and experienced with this system. The Operator shall be aware of any magnetic anomalies on the surface of the drill path and shall consider such influences in the operation of the guidance system if using a magnetic system.

### **III.3.2. BORE TRACKING AND MONITORING**

At all times during the pilot bore the Contractor shall provide and maintain a bore tracking system that is capable of accurately locating the position of the drill head in the x, y, and z axes. The Contractor shall record these data at least once per drill pipe length.

#### **III.3.2.1. Downhole And Surface Grid Tracking System**

Contractor shall monitor and record x, y, and z coordinates relative to an established surface survey bench mark. The data shall be continuously monitored and recorded at least once per drill pipe-length.

#### **III.3.2.2. Deviations from Bore Path**

Deviations shall be calculated and reported on the daily log. If the deviations exceed plus or minus 5 feet (horizontal or vertical deviation) from the design path, such occurrences shall be reported immediately to JEA. The Contractor shall undertake all necessary measures to correct deviations and return to design line and grade.

## **III.4. DRILLING FLUID (MUD) SYSTEM:**

# ***JEA Water and Wastewater Standards***

## ***755 Large Pipe Horizontal Directional Drilling (larger than 12")***

### **III.4.1. MIXING SYSTEM**

A self-contained, closed, drilling fluid mixing system shall be of sufficient size to mix and deliver drilling fluid. Mixing system shall continually agitate the drilling fluid during operations.

### **III.4.2. DRILLING FLUIDS**

Drilling fluid shall be composed of clean water, appropriate additives and clay. Water shall be from an authorized source with a minimum pH of 6.0. Water of a lower pH or with excessive calcium shall be treated with the appropriate amount of sodium carbonate or equal. The water and additives shall be mixed thoroughly and be absent of any clumps or clods. No potentially hazardous material may be used in drilling fluid.

### **III.4.3. DELIVERY SYSTEM**

The delivery system shall have filters in-line to prevent solids from being pumped into the drill pipe. Connections between the pump and drill pipe shall be relatively leak-free. Used drilling fluid and drilling fluid spilled during drilling operations shall be contained and conveyed to the drilling fluid recycling system or disposed of properly. A berm, minimum of 12" high, shall be maintained around drill rigs, drilling fluid mixing system, entry and exit pits and drilling fluid cycling system to prevent spills into the surrounding environment. Pumps and or vacuum truck(s) of sufficient size shall be in place to convey excess drilling fluid from containment areas to storage, recycling, and disposal facilities.

### **III.4.4. DRILLING FLUID VISCOSITY**

In the event that inadvertent returns or returns loss of drilling fluid occurs during pilot hole drilling operations, Contractor shall cease drilling, wait at least 30 minutes, inject a quantity of drilling fluid with a viscosity exceeding 120 seconds as measured by a Marsh funnel and then wait another 30 minutes. If mud fracture or returns loss continues, Contractor shall cease operations and notify JEA Representative. JEA Representative and Contractor shall discuss additional options and work will then proceed accordingly.

### **III.4.5. DRILLING FLUID PRESSURES AND FLOW RATES**

Drilling fluid pressures including drilling fluid pressure in the borehole annular space and flow rates shall be continuously monitored and recorded by the Contractor. These measurements shall be made during pilot bore drilling, reaming, and pullback operations.

### **III.4.6. DRILLING FLUID RECYCLING SYSTEM**

The drilling fluid recycling system shall separate sand, dirt and other solids from the drilling fluid to render the drilling fluid re-usable. Spoils separated from the drilling fluid will be stockpiled for later use or disposal.

### **III.4.7. CONTROL OF DRILLING FLUIDS**

The Contractor shall follow all requirements of the Frac-Out and Surface Spill Contingency Plan as submitted and approved and shall control operational pressures, drilling mud weights, drilling speeds, and any other operational factors required to avoid hydrofracture fluid losses to formations, and control drilling fluid spillage. This includes any spillages or returns at entry and exit locations or at any intermediate point. All inadvertent returns or spills shall be promptly contained and cleaned up. The Contractor shall maintain on-site mobile spoil removal equipment during all drilling, pre-reaming, reaming and pullback operations and shall be capable of quickly removing

# ***JEA Water and Wastewater Standards***

## ***755 Large Pipe Horizontal Directional Drilling (larger than 12")***

spoils. The Contractor shall immediately notify JEA of any inadvertent returns or spills and immediately contain and clean up the return or spill.

### **III.5. OTHER EQUIPMENT**

#### **III.5.1. PIPE ROLLERS**

Pipe rollers, if utilized, shall be of sufficient size to fully support the weight of the pipe while being hydro-tested and during pull-back operations. Sufficient number of rollers shall be used to prevent excess sagging of pipe.

#### **III.5.2. PIPE RAMMERS**

Hydraulic or pneumatic pipe rammers may only be used if necessary and with the authorization of JEA Representative.

#### **III.5.3. RESTRICTIONS**

Other devices or utility placement systems for providing horizontal thrust other than those defined above in the preceding sections shall not be used unless approved by the JEA Representative prior to commencement of the work. Consideration for approval will be made on an individual basis for each specified location. The proposed device or system will be evaluated prior to approval or rejection on its potential ability to complete the utility placement satisfactorily without undue stoppage and to maintain line and grade within the tolerances prescribed by the particular conditions of the projects.

#### **III.5.4. DATA LOGGER**

A data logger shall be used to record and document all butt weld fusion processes. A record shall be made of every fusion weld made. The data logger shall be of rugged, handheld computer as the recording device connected to a data collection device. The data collection device shall record the heater temperature and fusion pressure profile over time. All data shall be recorded and transmitted to the handheld computer where the joint report will be stored, viewed, printed, or transferred to a desk top computer for archiving. The operator associated with the fusion process shall utilize the data logger report as one means to confirm a complete and proper weld. This data shall be made immediately available to the JEA representative, upon request, unless approved otherwise by JEA, a written or downloader report for each fusion weld process shall be required and submitted to the JEA representative within ten working days after the fusion weld process for review and approval. If a potential defect fusion weld is suspected by JEA or the contractor, the work shall stop and a mutually acceptable (between the contractor and JEA) corrective action plan shall be executed.

### **IV. DRILLING PROCEDURES**

#### **IV.1. DRILL PATH**

Prior to drilling Contractor shall utilize all verified locate information to determine drill pathway. Marked up drawings (see Site Preparation paragraph) shall be on site at all times, and referred to during the drill operation.

#### **IV.2. GUIDANCE SYSTEM**

Contractor shall provide and maintain instrumentation necessary to accurately locate the pilot hole (both horizontal and vertical displacements), measure pilot string torsional and axial forces and measure drilling

# *JEA Water and Wastewater Standards*

## *755 Large Pipe Horizontal Directional Drilling (larger than 12")*

fluid discharge rate and pressure. The JEA Representative shall have access to instrumentation and readings at all times during operation.

### **IV.3. PILOT HOLE**

The pilot hole shall be drilled along the path shown on the plans and profile drawings. Unless approved otherwise by JEA, the pilot-hole tolerances shall be as follows:

#### **IV.3.1. ELEVATION**

As shown on the plans.

#### **IV.3.2. ALIGNMENT**

5 feet within the right-of-way or easement boundary.

#### **IV.3.3. CURVE RADIUS**

The pilot hole radius shall be no less than 80% of the maximum bending radius as recommended by the pipe manufacturer of the pipe being installed. In no case shall the bending radius be less than 30 pipe diameters, unless approved otherwise by JEA.

#### **IV.3.4. ENTRY POINT LOCATIONS**

The exact pilot hole entry point shall be within  $\pm 5$  feet of the location shown on the drawing without prior JEA written permission for deviation.

#### **IV.3.5. EXIT POINT LOCATION**

The exit point location shall be within  $\pm 5$  feet of the location shown on the drawing without prior JEA written permission for deviation.

#### **IV.3.6. LIMITATIONS ON DEPTH**

HDPE pipe larger than bore hole path shall be specifically designed by the engineer and approved by JEA. Where utilities cross under DOT roads, the depth of cover shall comply with applicable DOT permit.

### **IV.4. WATER MAIN AND NON-WATER MAIN SEPARATION REQUIREMENTS**

The minimum separation requirements between HDPE water main and a non-water main shall be as outlined in specification chapter III. 1. - Section 350 and Detail Nos. W-10 and W-11.

### **IV.5. PULL BACK**

After successfully reaming bore hole to the required diameter, Contractor will pull the pipe through the bore hole. In front of the pipe will be a swivel and appropriate tools per the contractor's approved work plan. Once pull-back operations have commenced, operations must continue without interruption until pipe is completely pulled into bore hole. During pull-back operations Contractor will not apply more than the maximum safe pipe pull force at any time. Maximum allowable tensile force imposed on the pull section shall be equal to 80% of the pipe manufacturer's safety pull (or tensile) strength.

**IV.5.1.** Torsional stress shall be minimized by using a swivel to connect a pull section to the reaming assembly.

# *JEA Water and Wastewater Standards*

## *755 Large Pipe Horizontal Directional Drilling (larger than 12")*

- IV.5.2. The pullback section of the pipeline shall be supported during pullback operations so that it moves freely and the pipe is not damaged.
- IV.5.3. External pressure shall be minimized during installation of the pullback section in the reamed hole. Damaged pipe resulting from external pressure shall be replaced at no cost to the JEA.
- IV.5.4. Buoyancy modification shall be at the discretion of the Contractor and shall be approved by the JEA Representative. The Contractor shall be responsible for any damage to the pull section resulting from such modifications.
- IV.5.5. In the event that pipe becomes stuck, Contractor will cease pulling operations to allow any potential hydro-lock to subside and will commence pulling operations. If pipe remains stuck, Contractor will notify JEA Representative. JEA Representative and Contractor will discuss options and then work will proceed accordingly.

### **IV.6. PIPE ASSEMBLY**

Pipe shall be welded/fused together in one length, if space permits. Pipe shall have no more than three (3) welds per 20 foot section. Pipe may be placed on pipe rollers before pulling into bore hole to minimize damage to the pipe. It is critical that all original oxidized pipe surface be removed in order for fusion to take place. The scraping process requires that approximately .10" of the outer "skin" be removed in order to penetrate the oxidation and contamination barrier. Oxidized pipe surface simply will not bond.

#### **IV.6.1. DAMAGED PIPE**

Cuts or gouges that reduce the wall thickness by more than 10% is not acceptable and must be cut out and discarded.

#### **IV.6.2. BUTT FUSION LOG**

Each butt fusion shall be recorded and logged by an electronic monitoring device affixed to the fusion machine. Joint data shall be submitted as part of the As-Recorded information, in accordance with this specification.

#### **IV.6.3. BUTT FUSION TESTING**

When requested by a JEA inspector, butt fusion testing will be performed. The test fusion shall be allowed to cool completely, and then fusion test coupons shall be cut out. The test shall utilize test coupons (conducted in accordance with manufactures recommendations).

#### **IV.6.4. MECHANICAL JOINING**

Polyethylene pipe and fittings may be joined together or to the materials by means of flanged connections (flange adapters, electrofused couplings, and back-up rings) or mechanical couplings designed for joining polyethylene pipe or for joining polyethylene pipe to another material. Mechanical couplings shall be fully pressure rated and fully thrust restrained such that when installed in accordance with manufacturer's recommendations, a longitudinal load applied to the mechanical coupling will cause the pipe to yield before the mechanical coupling disjoins. External joint restraints shall not be used in lieu of fully restrained mechanical couplings.

#### **IV.6.5. SPECIAL CONSTRUCTION REQUIREMENTS FOR 24-INCH AND LARGER PIPE**

For HDPE pipe 24-inch and larger, unless approved otherwise by JEA, a foundation bed of granular material (57 stone) shall be placed under and around all ductile iron fittings and valves



# ***JEA Water and Wastewater Standards***

## ***755 Large Pipe Horizontal Directional Drilling (larger than 12")***

for additional support of heavy system components A foundation bed of granular material shall be provided for all valves 20 size and larger. For granular materials, the minimum vertical limit is 12 inches under the fitting or valve, up to 1/3 the overall height of the fitting or valve. The minimum horizontal limits of the granular material shall be 12 inches in all directions beyond the outer edges of the fitting or valve. The compaction of soils below the granular material shall be at 98% of the maximum density. Payment for this work shall be included in the associated fitting or valve unit cost. All spool pieces between 24 inch and larger ductile fittings and valves shall be at least 5 feet long. No joint deflection shall be allowed at the fittings or valves.

### **IV.7. GENERAL REQUIREMENTS FOR OPEN-CUT CONSTRUCTION**

#### **IV.7.1. MATERIALS**

Mains shall be constructed of the materials specified and as shown on the drawings.

#### **IV.7.2. HANDLING**

Pipe and fittings shall be carefully handled to avoid damage, and if feasible, while they are suspended over the trench before lowering, they shall be inspected for defects and to detect cracks. Defective, damaged or unsound pipe or fittings shall be rejected.

#### **IV.7.3. FILL**

Each section of the pipe shall rest upon the pipe bed for the full length of its barrel. Any pipe which has its grade or joint disturbed after laying shall be taken up and re-laid. Only suitable soils (no heavy clay) shall be utilized in the backfill operation up to 12 inches above the pipe.

#### **IV.7.4. CLEAN PIPE PRECAUTIONS**

All precautions shall be taken to prevent sand or other foreign material from entering the pipe during installation. If necessary, a heavy, tightly woven canvas bag of suitable size shall be placed over each end of the pipe before lowering into the trench and left there until the connection is made to the adjacent pipe. Any time the pipe installation is not in progress, the open ends of pipe shall be closed by a watertight plug or other method approved by the Engineer. Plugs shall remain in pipe ends until all water is removed from the trench. Any sand or foreign material that enters the pipe shall be removed from the pipe immediately.

#### **IV.7.5. STANDING WATER**

No pipe shall be installed when trench conditions (standing water, excess mud, etc.) or the weather (rain, etc.) is unsuitable for such work, except by permission of the Engineer. Any section of pipe already laid which is found to be defective or damaged shall be replaced with new pipe.

#### **IV.7.6. UTILITY LOCATES**

The contractor shall coordinate utility locates with Sunshine State One-Call of Florida, Inc. (# 811), at a minimum.

#### **IV.7.7. COVER AND DEPTH**

Cover for pipe under pavement shall be measured from the finished grade. Any reduction in pipe cover will require approval from JEA and the Engineer. Greater depths will be permitted where required to miss obstructions only. Lines shall be located as shown on the drawings. The Contractor shall investigate well in advance of pipe laying any conflicts which may require

# *JEA Water and Wastewater Standards*

## *755 Large Pipe Horizontal Directional Drilling (larger than 12")*

readjustments in planned locations and advise the Engineer of the results of these investigations so that the Engineer may give instructions as to the modifications required.

#### **IV.7.8. JEA STANDARDS**

Refer to Section 408 for over excavation, backfill and compaction requirements.

#### **IV.8. AIR RELEASE VALVES**

Provide air release valve for all wastewater force main installations as indicated on drawings utilizing all stainless steel threaded outlet tapping sleeve.

### **V. SWABBING**

The purpose of swabbing a new pipeline is to conserve water while thoroughly cleaning the pipeline of all foreign material, sand, gravel, construction debris and other items not found in a properly cleaned system. Prior to pressure testing of a new pipeline swabbing shall be utilized for each project. Swabbing details, Chapter VIII, Plates W-45, W-45A, W-45B, W-45C and W-45D.

- V.1.1. All new water, wastewater force, and reclaim mains greater than 12" I.D. (with exceptions to smaller pipe lines as deemed necessary by JEA) shall be hydraulically cleaned with a polypropylene swabbing device to remove dirt, sand and debris from main.
- V.1.2. If swabbing access and egress points are not provided in the design drawings, it will be the responsibility of the Contractor to provide temporary access and egress points for the cleaning, as required.
- V.1.3. Passage of cleaning poly swabs through the system shall be constantly monitored, controlled and all poly swabs entered into the system shall be individually marked and identified so that the exiting of the poly swabs from the system can be confirmed.
- V.1.4. Cleaning of the system shall be done in conjunction with, and prior to, the initial filling of the system for its hydrostatic test.
- V.1.5. The Contractor shall insert flexible polyurethane foam swabs (two pounds per cubic foot density) complete with rear polyurethane drive seal, into the first section of pipe. The swabs shall remain there until the pipeline construction is completed. A JEA representative shall be present for the swabbing process including swab insertion and retrieval.
- V.1.6. The line to be cleaned shall only be connected to the existing distribution system at a single connection point.
- V.1.7. Locate and open all new in-line valves beyond the point of connection on the pipeline to be cleaned during the swabbing operation.
- V.1.8. At the receiver or exit point for the poly swab, the CONTRACTOR is responsible for creating a safe environment for collection of debris, water and the swab. Considerations shall be made for protecting surrounding personnel and property and safe retrieval of the swab.
- V.1.9. Only with JEA personnel on-site shall the supply valve from the existing distribution system be operated. Cleaning and flushing shall be accomplished by propelling the swab down the pipeline

# *JEA Water and Wastewater Standards*

## *755 Large Pipe Horizontal Directional Drilling (larger than 12")*

to the exit point with potable water. Flushing shall continue until the water is completely clear and swab(s) is/are retrieved.

- V.1.10. Re-apply a series of individual swabs in varying diameters and/or densities as required, to attain proper cleanliness of pipeline.
- V.1.11. Swabbing speed shall range between two and five feet per second.
- V.1.12. After the swabbing process, pressure testing and disinfection of the pipe shall be completed in accordance with this manual.

## **VI. TESTING**

### **VI.1. DISINFECTION TESTS:**

- VI.1.1. All water pipe and fittings shall be thoroughly disinfected prior to being placed in service. Disinfection shall follow the applicable provisions of the procedure established for the disinfection of water mains as set forth in AWWA - Standard C651 entitled "AWWA Standard for Disinfecting Water Mains" and shall be in accordance with Chapter III. 1. - Section 350. Bacteriological testing on the water main shall be scheduled and completed by JEA. JEA will collect the water samples and be responsible for completing the water analysis (lab testing).
- VI.1.2. Temporary blow-offs shall be installed for the purpose of cleaning the water main. Blow-offs installed on water mains up to and including 12 inches shall be the same diameter as the water main. Blow-offs installed on 16-inch water mains and larger shall be the next smaller size, in diameter, than the water main being tested. Temporary blow-offs shall be removed and plugged after the main is cleared. The JEA Representative shall be present prior to and during the operation of blow-offs. The main shall be flushed prior to disinfection.
- VI.1.3. The new water main shall be connected to the existing water main at one point only for flushing purposes (no looping). The new main **MUST** have a blow off on the end as required previously. After the new main is thoroughly flushed, the open end shall be sealed and restrained and the main shall be thoroughly disinfected. Anytime the new line is reopened (to repair defective joints or pipe, defective fitting or valve) the complete disinfection process shall be repeated. Once bacteriological clearance has been received from the regulatory authority, the new main may be pressure tested.

### **VI.2. PRESSURE AND LEAKAGE TESTS**

- VI.2.1. Contractor shall test pipelines installed under this Contract in accordance with these specifications prior to acceptance of the pipeline by the JEA. All field tests shall be made in the presence of the JEA Representative. Except as otherwise directed, all pipelines shall be tested. Unless approved otherwise by JEA, all fusible or butt weld joints shall be tested, including MJ adapter fittings associated with the new construction. All piping to operate under liquid pressure shall be tested in sections of approved length. The pressure testing of an HDPE line section shall be tested separately from the PVC and DIP line sections. Where impractical, the HDPE test section shall include only a minimum amount of PVC and ductile iron pipe within the test section. If at all possible, the PVC and D.I.P. test sections shall be left exposed during the pressure test for visual leakage observation. For these tests, the Contractor shall furnish clean water, suitable temporary

## *JEA Water and Wastewater Standards*

### *755 Large Pipe Horizontal Directional Drilling (larger than 12")*

testing plugs or caps, and other necessary equipment, and all labor required. If the Contractor chooses to pressure test against an existing JEA water main/valve, the new water main must be disinfected prior to connection to the JEA line. The JEA will not be responsible for failure of the pressure test due to the existing valve leaking. JEA may elect to furnish suitable pressure gauges for these tests. If not, the contractor will furnish suitable pressure gauges, calibrated by an approved testing laboratory, which increments no greater than 2 psi. Gauges used shall be of such size that pressures tested will not register less than 10% or more than 90% of the gauge capacity. All valved sections shall be hydrostatic tested to insure sealing (leak allowance) of all line valves. All HDD over 100 LF shall be air pressure tested (above ground) @ 5 PSI for a period of 15 minutes, prior to insertion. There shall be no pressure loss allowed.

- VI.2.2. Unless it has already been done, the section to pipe to be tested shall be filled with potable water and air shall be expelled from the pipe. Reclaimed water may be utilized for filling new reclaimed water or wastewater force main installations. If blow offs or other outlets are not available at high points for releasing air, the Contractor shall provide 1-inch (minimum taps and blow-off valves (at the 12:00 position), as necessary. The cost of constructing blow-off valves and plugging them, after a successful pressure test, shall be included in the unit price bid amount for the HDPE pipe.
- VI.2.3. For mains larger than 20-inch size, the contractor shall profile (line and grade) the main after installation and prior to pressure and leakage test to accurately locate all high points. Field survey instrument (Level equipment) shall be utilized for this task. Blow off valves shall be installed (at a minimum) at all high points which offset vertically more than two pipe diameters in length (at a minimum). The contractor shall consult the design engineer on any technical questions or concerns.
- VI.2.4. Hydrostatic testing shall consist of a 150 psig test pressures, based on the elevation of the highest point of the line or section under tests. Pressure shall be applied by means of a pump connected to the pipe in a manner satisfactory to the JEA Representative. The pump, pipe connection and all necessary apparatus shall be furnished by the Contractor and shall be subject to the approval of the JEA Representative.
- VI.2.5. Maximum duration for pressure test, including initial and final phase of the test, shall not exceed eight (8) hours. If the test is not completed due to leakage, equipment failure, etc., depressurize the test section, and then allow it to "relax" for at least eight (8) hours before bringing the test section up to test pressure again.
- VI.2.5.1. Initial Phase of Pressure Testing
- First, all air must be removed from the test section. The pressure test shall be completed after the line is backfilled. If possible, all flanged or mechanical joint valves and fittings shall be left exposed for visual leak inspection. If possible all PVC and D.I.P. test sections shall be left exposed for visual leak inspection. Initially, the pressure within the test section should be raised to approximately 160 psi and then allowed to be idle (no additional make-up water/pressure to be injected), for approximately 3 hours. During this 3 hour period, the test section shall be allowed to stabilize and come to an equilibrium stage. No additional make-up water/pressure shall be applied to the test section during this 3 hour stabilization period unless the line pressure drops below 140 psi. In this case, make-up water/pressure shall only be applied to the test section to maintain a minimum of 140 psi (during the 3 hour stabilization period).

# ***JEA Water and Wastewater Standards***

## ***755 Large Pipe Horizontal Directional Drilling (larger than 12")***

### VI.2.5.2. Final Phase of Pressure Testing

The final phase of the pressure test shall involve applying make-up water/pressure to achieve an "initial test pressure" of 150 psi (minimum)/155 psi (maximum). The test section is then allowed to be idle (no make-up water/pressure is added) for a period of 2 hours. After this 2-hour period, make-up water/pressure is applied and measured to re-establish the "initial test pressure". The quantity of water utilized to re-pump the line shall be measured and compared to the allowable quantities as determined by the table below. If the actual make-up water quantity is equal or less than the allowable amount, the pressure test passes. If the actual make-up water quantities are greater than the allowable amount, the pressure test fails (see enclosed JEA test form).

<b>Table 1: Allowable Make Up Amount</b>	
<b>Nominal Pipe Size (inches)</b>	<b>Make-up Water Allowance (Gallons/Linear feet of Pipe) 2-hour test</b>
6	0.0030
8	0.0050
10	0.0065
12	0.0115
14	0.0140
16	0.0165
18	0.0215
20	0.0275
22	0.0350
24	0.0440
26	0.0500
28	0.0555
30	0.0635
32	0.0715
34	0.0810
36	0.0900
42	0.1155
48	0.1350
54	0.1570

VI.2.6. In the event a section fails to pass the tests, the Contractor shall do everything necessary to locate, uncover (even to the extent of uncovering the entire section), and replace the defective pipe, valve, fitting or joint. Visible leaks shall be corrected regardless of total leakage. Lines which fail to meet

# ***JEA Water and Wastewater Standards***

## ***755 Large Pipe Horizontal Directional Drilling (larger than 12")***

these tests shall be retested as necessary until test requirements are complied with. All testing shall be performed at the Contractor's expense.

- VI.2.7. If, in the judgment of JEA, it is impracticable to follow the foregoing procedures exactly for any reason, modifications in the procedure shall be made with approval; but, in any event, the Contractor shall be responsible for the ultimate tightness of the piping within the above requirement. Re-disinfection shall be required if the line is de-pressurized for repairs prior to tying.

### **VII. LOCATE WIRE**

Two locate wires shall be provided on all installations. For HDD projects, locate wire shall be 8 AWG high strength copper-clad carbon steel with 45 mils (min) insulation. For open-cut projects, the locate wire construction and testing shall meet the locate wire requirements, as specified in Chapter III. 1. - Section 350 and Chapter IV.3.-Section 429 [12 gauge, single strand, UF rated, copper-clad steel wire with 30 mil (minimum) insulation]. The external color shall be either blue for water, green for wastewater, purple for reuse, or black for raw water. Locate wire shall be brought to grade within a valve box or locate station box at all "entry point locations" and all "exit point locations". For HDD projects, there is no maximum length or interval between locate wire stations. The testing and report requirements within Chapter III. 1. - Section 350 and Chapter IV.3.-Section 429 shall be required except as modified herein. If both locate wires break or is not continuous (from end to end), the contractor shall, at the contractor's expense, provide soft-digs for the portions of the main with 12-feet or less cover (every 25 LF along main) to confirm as-built data. This soft-dig data shall be recorded on the as-built record drawings as specified here-in.

### **VIII.COMPLIANCE**

Failure to comply with the JEA Standards herein or failure to verify "As Builts" as required shall result in; the Contractor, Engineer, and Surveyor will be unable to bid future JEA projects and removed from the JEA approved contractor's list for a minimum of twelve months.

### **IX. INSPECTION CHECKLISTS AND REPORTS**

# JEA Water and Wastewater Standards

## 755 Large Pipe Horizontal Directional Drilling (larger than 12")

### IX.1. PRESSURE AND LEAKAGE TEST: HDPE PIPE

Project Name: \_\_\_\_\_

Test Section: \_\_\_\_\_

Availability Number: \_\_\_\_\_ Project Number: \_\_\_\_\_ Date/Time: \_\_\_\_\_

Date/Time Start: \_\_\_\_\_ Date/Time Finish: \_\_\_\_\_

STA/Offset Start: \_\_\_\_\_ STA/Offset Finish: \_\_\_\_\_

Other Test Phase Attendees: \_\_\_\_\_  
 \_\_\_\_\_  
 \_\_\_\_\_  
 \_\_\_\_\_

Service:  Potable Water  
 Reclaimed Water  
 Wastewater

#### Line Pressure Test:

Start: \_\_\_\_\_ PSI Minimum of 150 PSI or 2 x the operating pressure

End: \_\_\_\_\_ PSI

PSI Difference: \_\_\_\_\_ PSI If greater than 5 psi, the test fails

Line Pressure Test Results  Pass  Fail

#### Line Leakage Test:

TYPE OF HDPE PIPE (DR RATING) (1)	DIAMETER OF PIPE (INCHES) (2)	LINEAR FEET (3)	2-HOUR TEST FACTOR (See Table Below *) (4)	TOTAL ALLOWABLE LEAKAGE (3x4) (5)
Total Allowable Leakage Amount (Gallons)				

## JEA Water and Wastewater Standards 755 Large Pipe Horizontal Directional Drilling (larger than 12")

JEA 2-HOUR TEST FACTORS			
*NOMINAL PIPE SIZE (inches) – ALLOWABLE LEAKAGE AMOUNT (Gallons/Linear Feet of Pipe)			
4" – 0.0020	6" – 0.0030	8" – 0.0050	10" – 0.0065
18" – 0.0215	20" – 0.0275	22" – 0.0350	24" – 0.0440
32" – 0.0715	34" – 0.0810	36" – 0.0900	42" – 0.1155
4" – 0.0020	6" – 0.0030	8" – 0.0050	10" – 0.0065
18" – 0.0215	20" – 0.0275	22" – 0.0350	24" – 0.0440
32" – 0.0715	34" – 0.0810	36" – 0.0900	42" – 0.1155

Allowable Leakage Amount \_\_\_\_\_ GAL      \_\_\_\_\_ Oz. (32 oz per qt, 128 oz per gal)

Actual Leakage Amount \_\_\_\_\_ GAL      \_\_\_\_\_ Oz.

Line Leakage Test Results     Pass     Fail

The above is based on the average pressure test of 150 PSI, 2 hour test period. If the actual leakage amount is equal or less than the allowable leakage amount, the leakage test is acceptable.

Comments:

---



---



---

Contractor Representative:

\_\_\_\_\_  
Signature & Printed Name

JEA Inspector:

\_\_\_\_\_  
Signature & Printed Name

JEA O&M representative:

\_\_\_\_\_  
Signature & Printed Name